

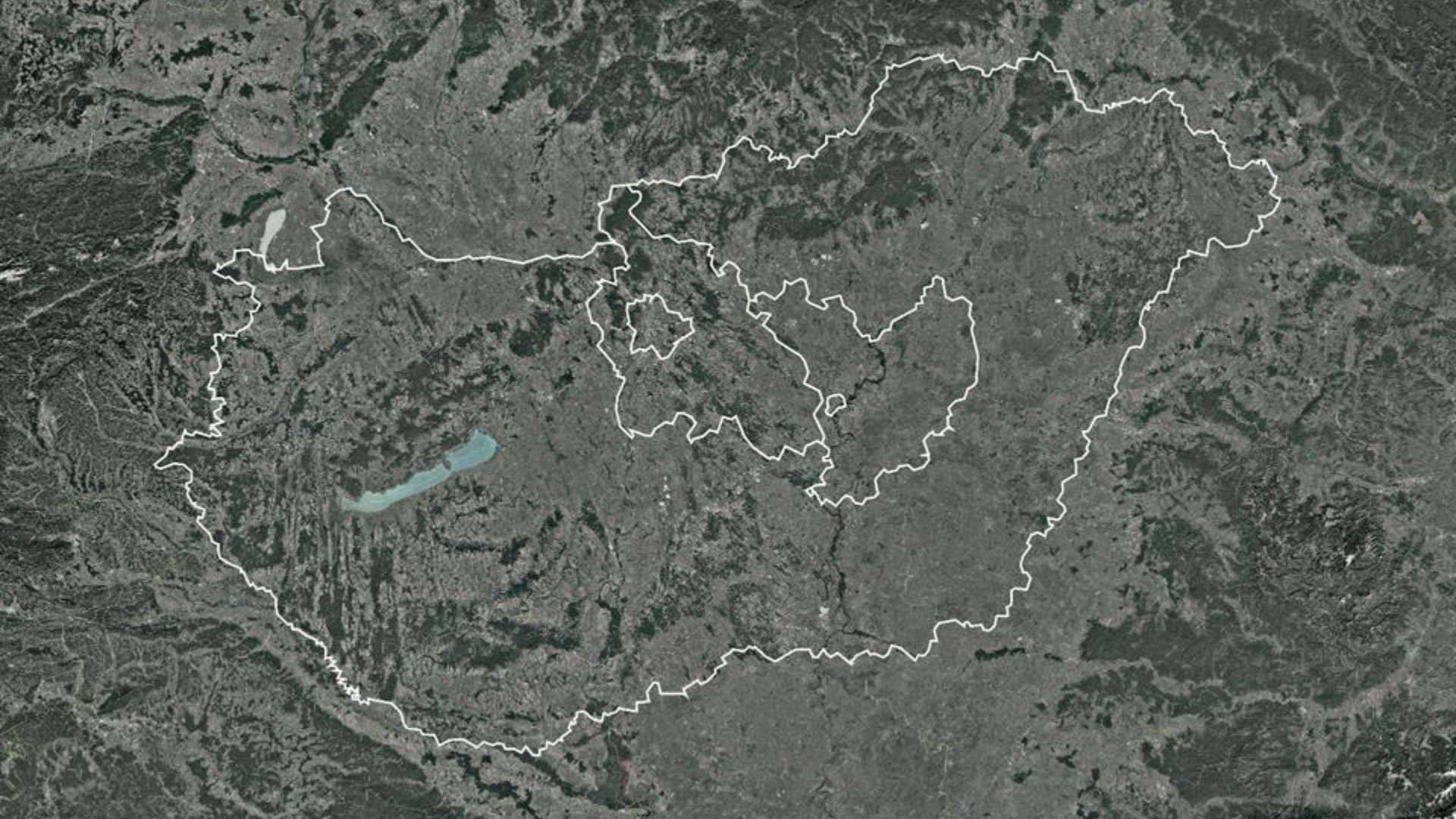

RAVATALOZÓ

SKULTÉTI BIANKA





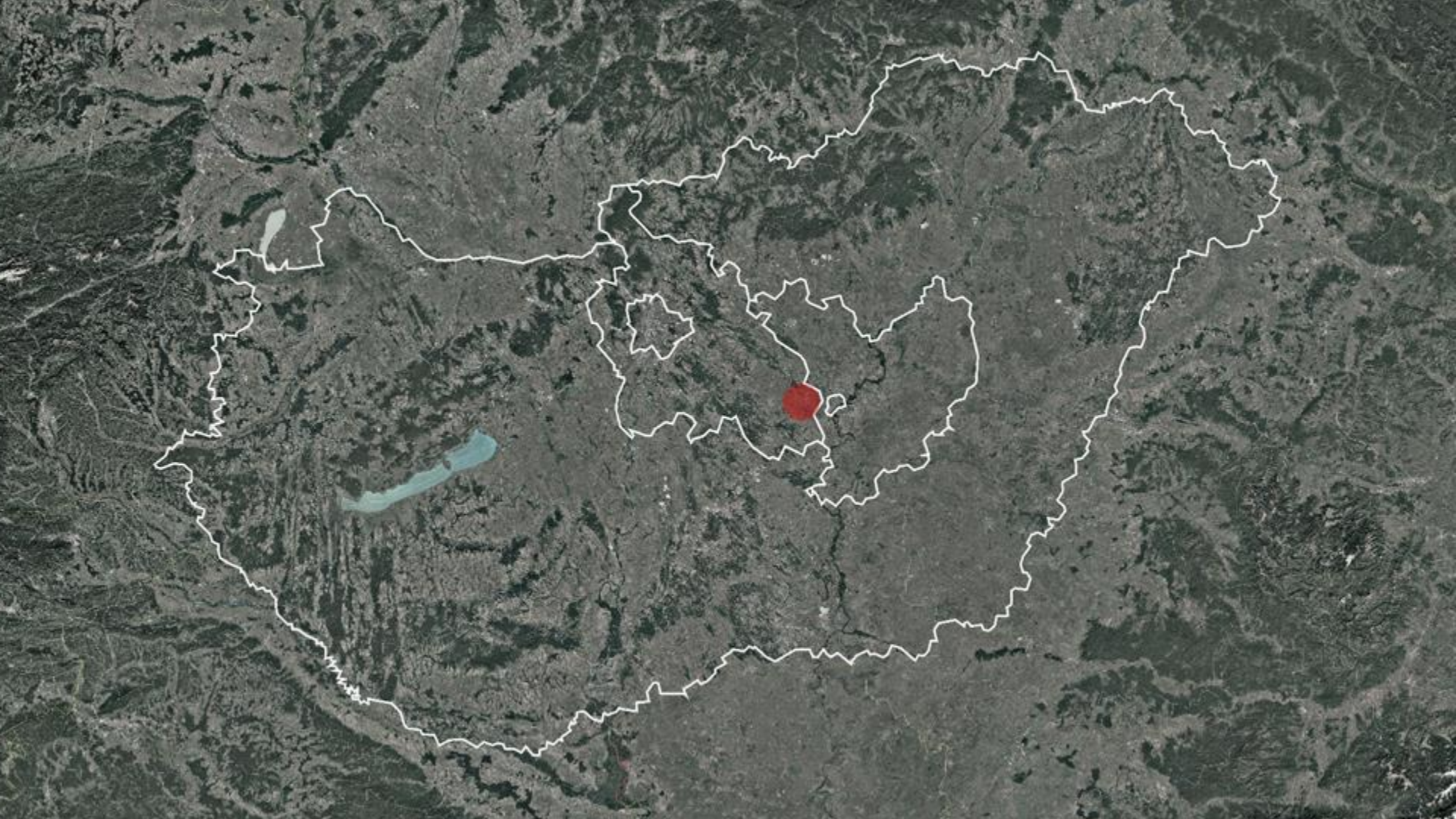







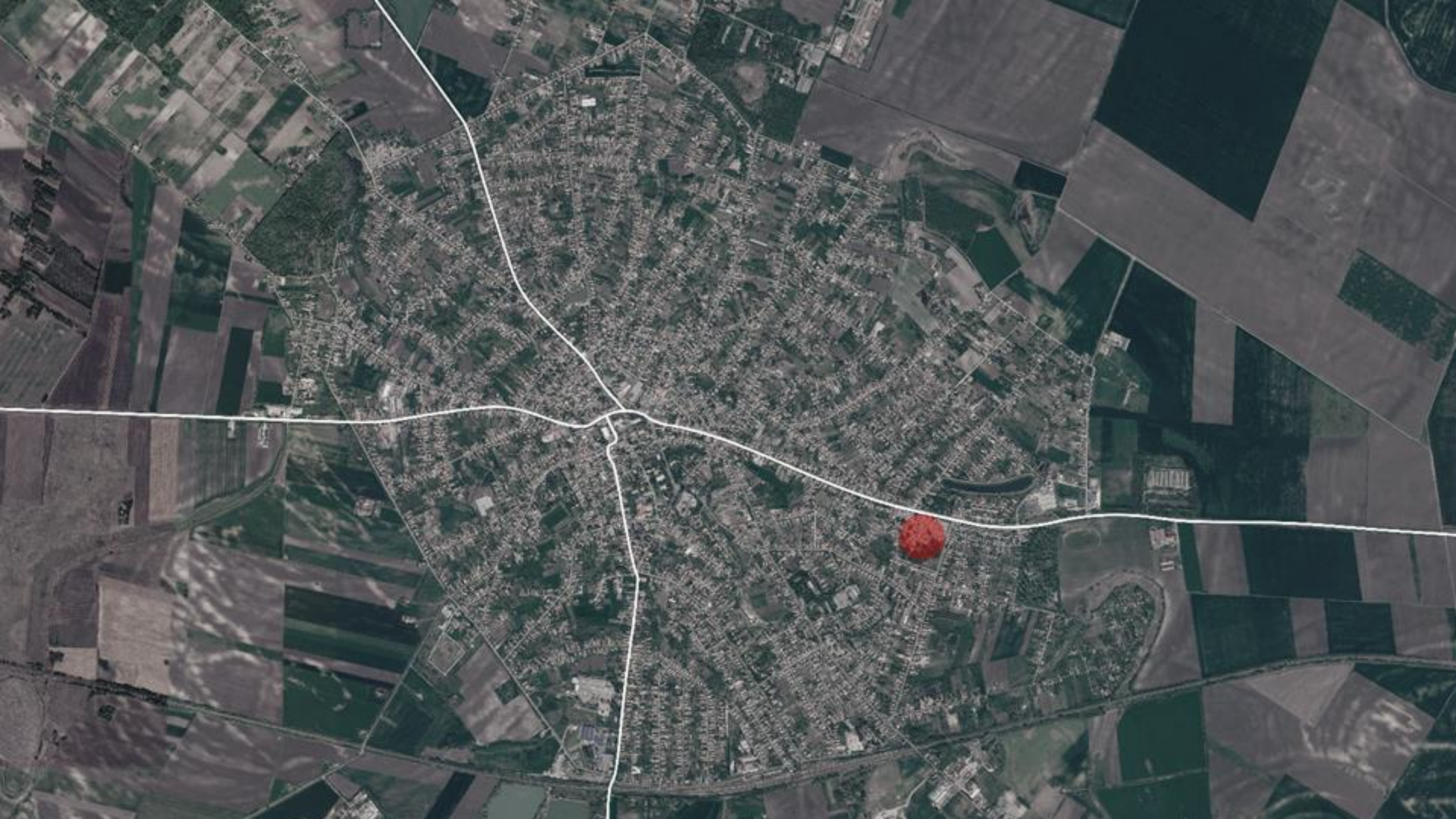

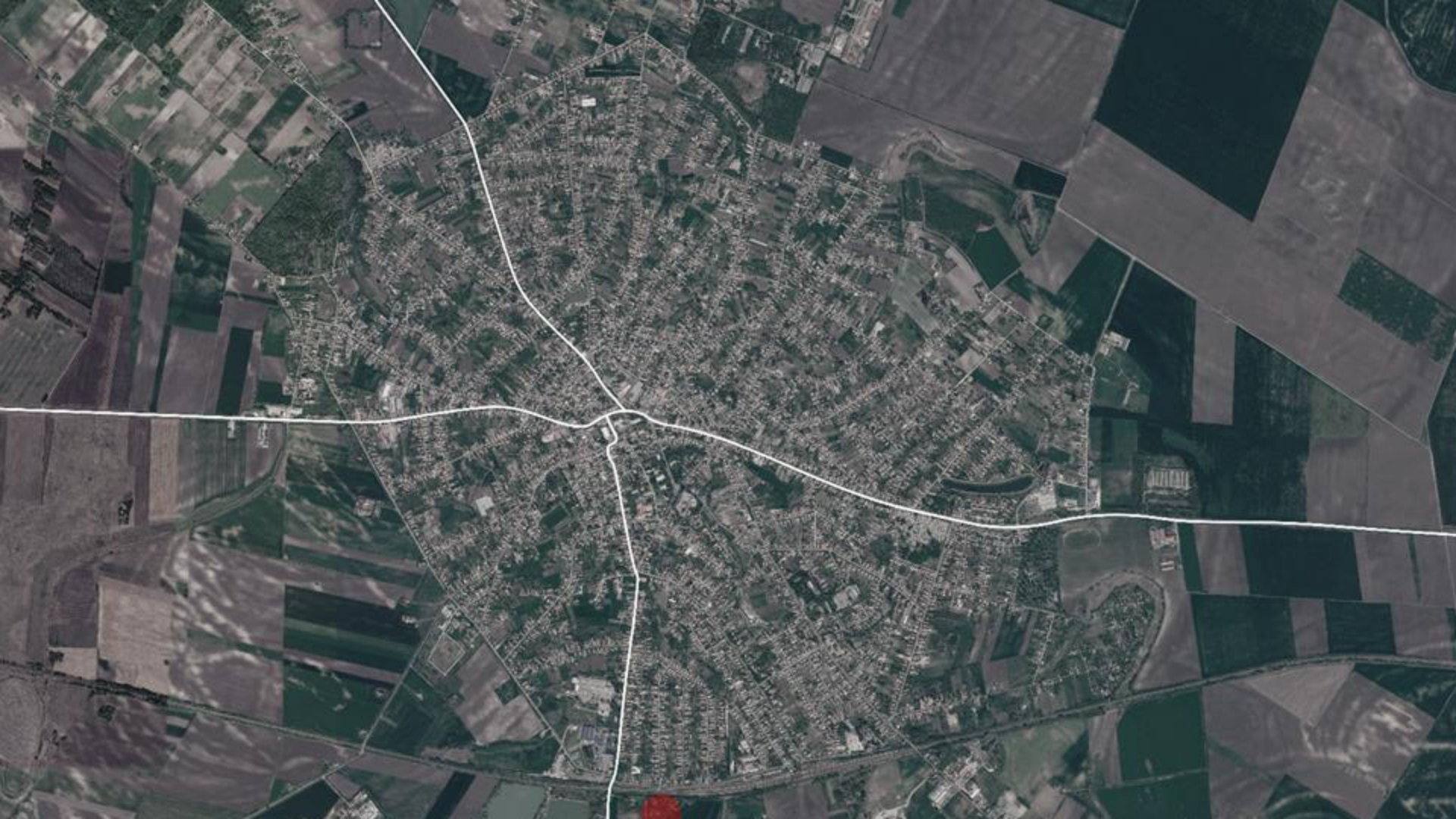

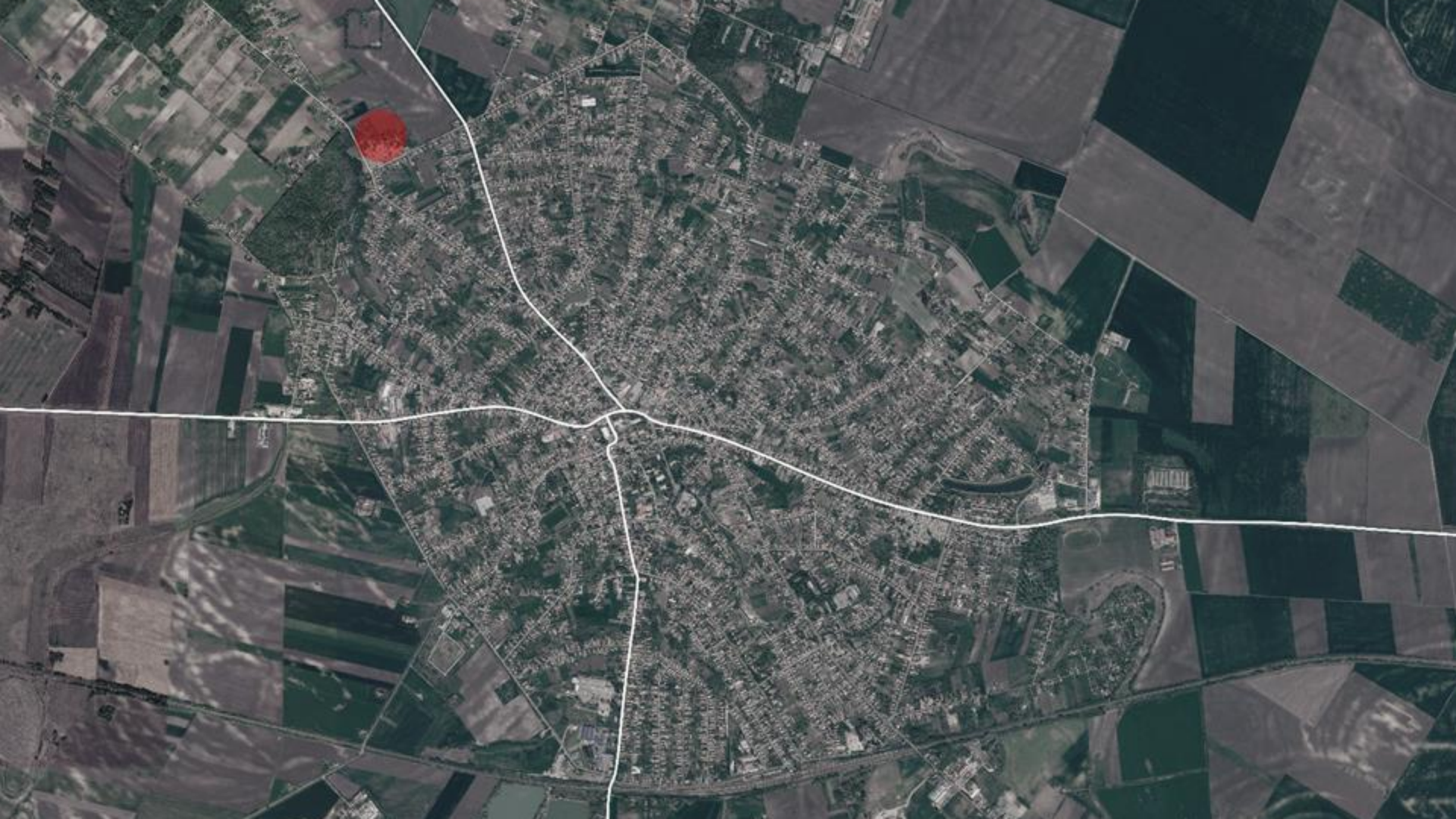































HANNA JÁNOS
1929 - 1979
GONZOL ROZÁLIA
1937 -
LÁNYI GYÖRGY
1938 - 1995









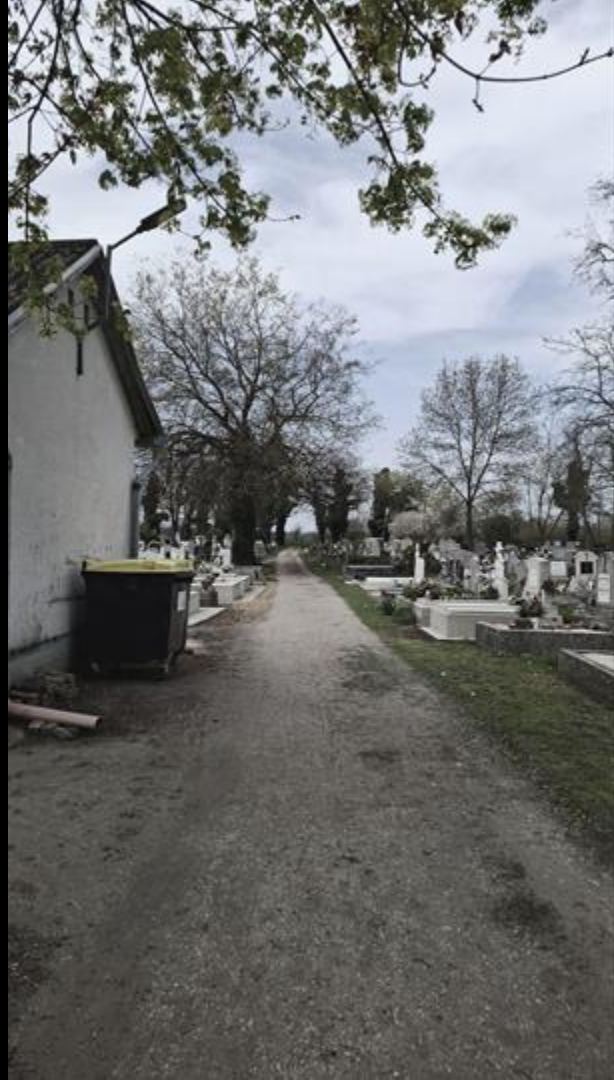

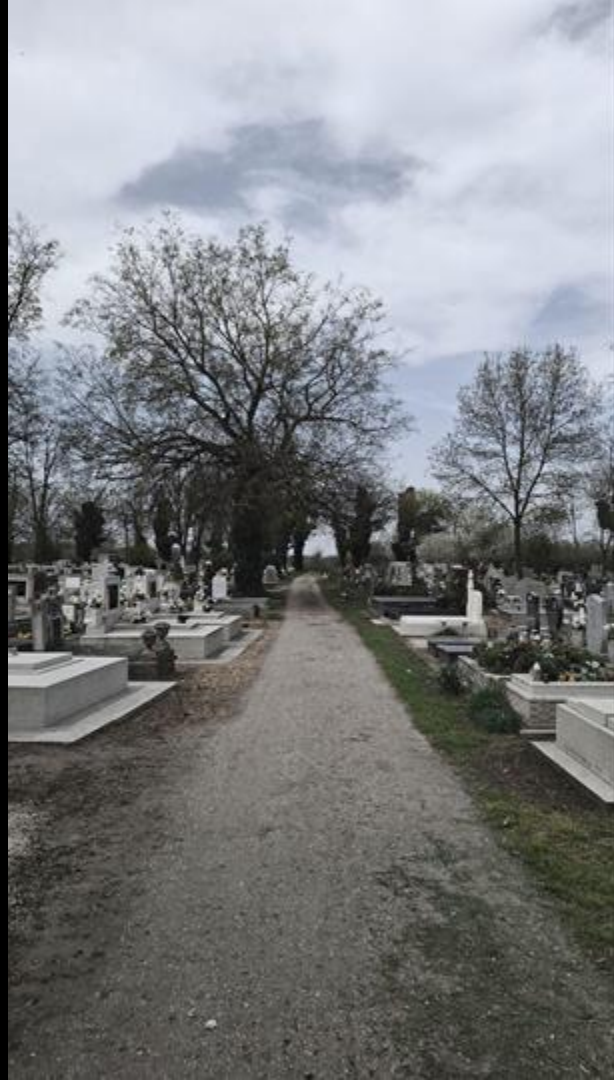

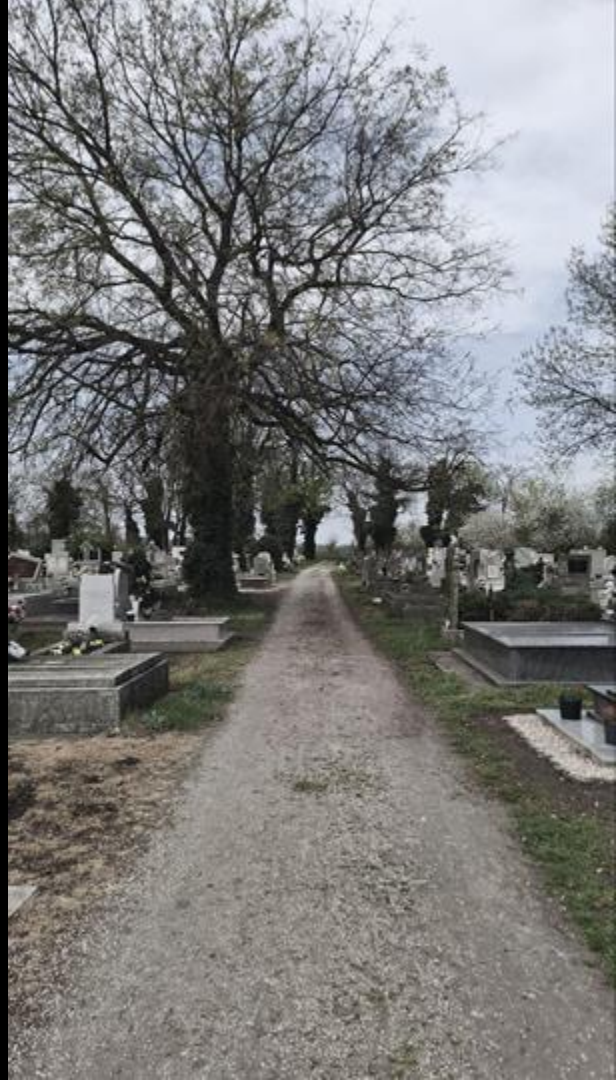

































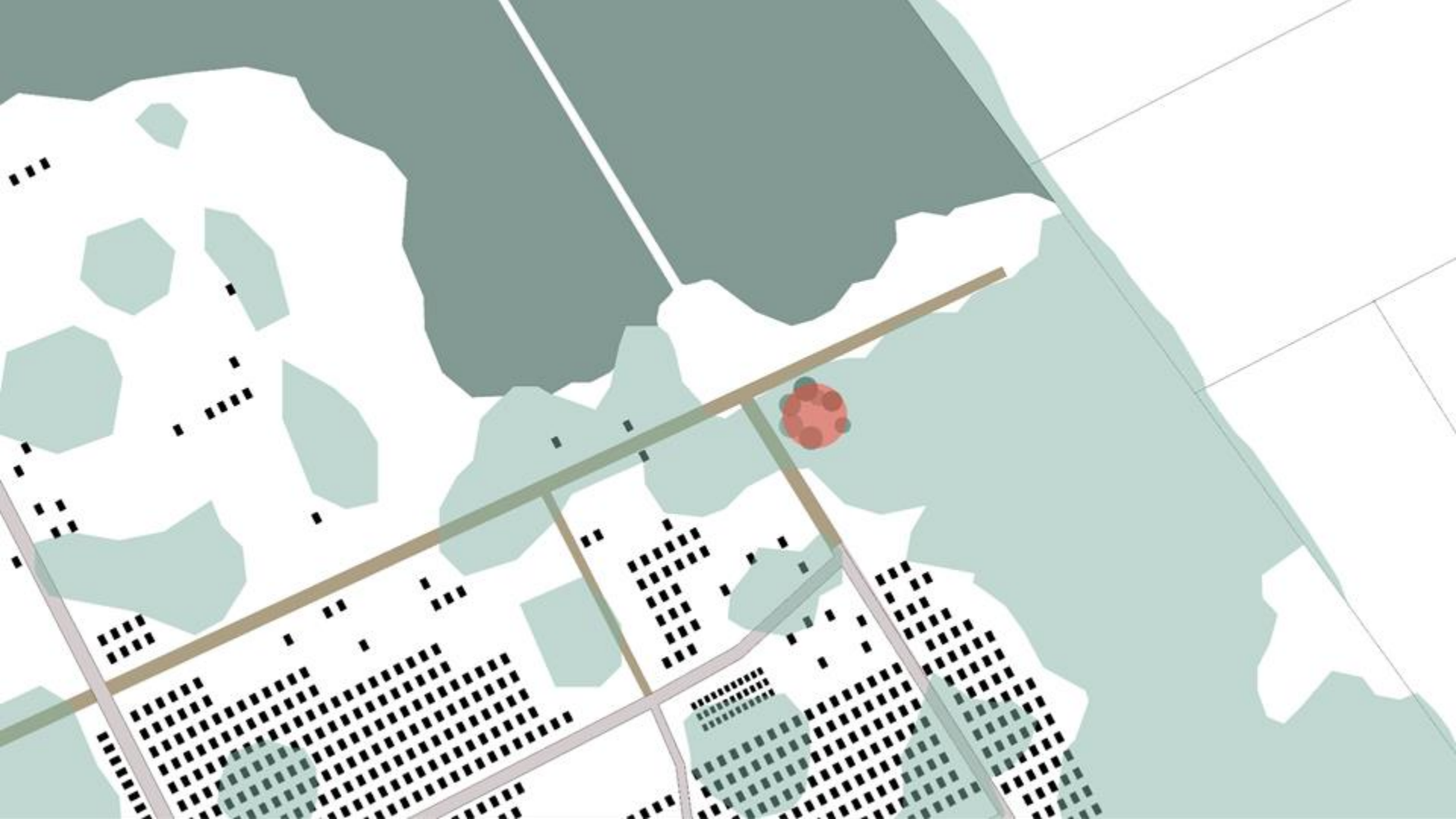







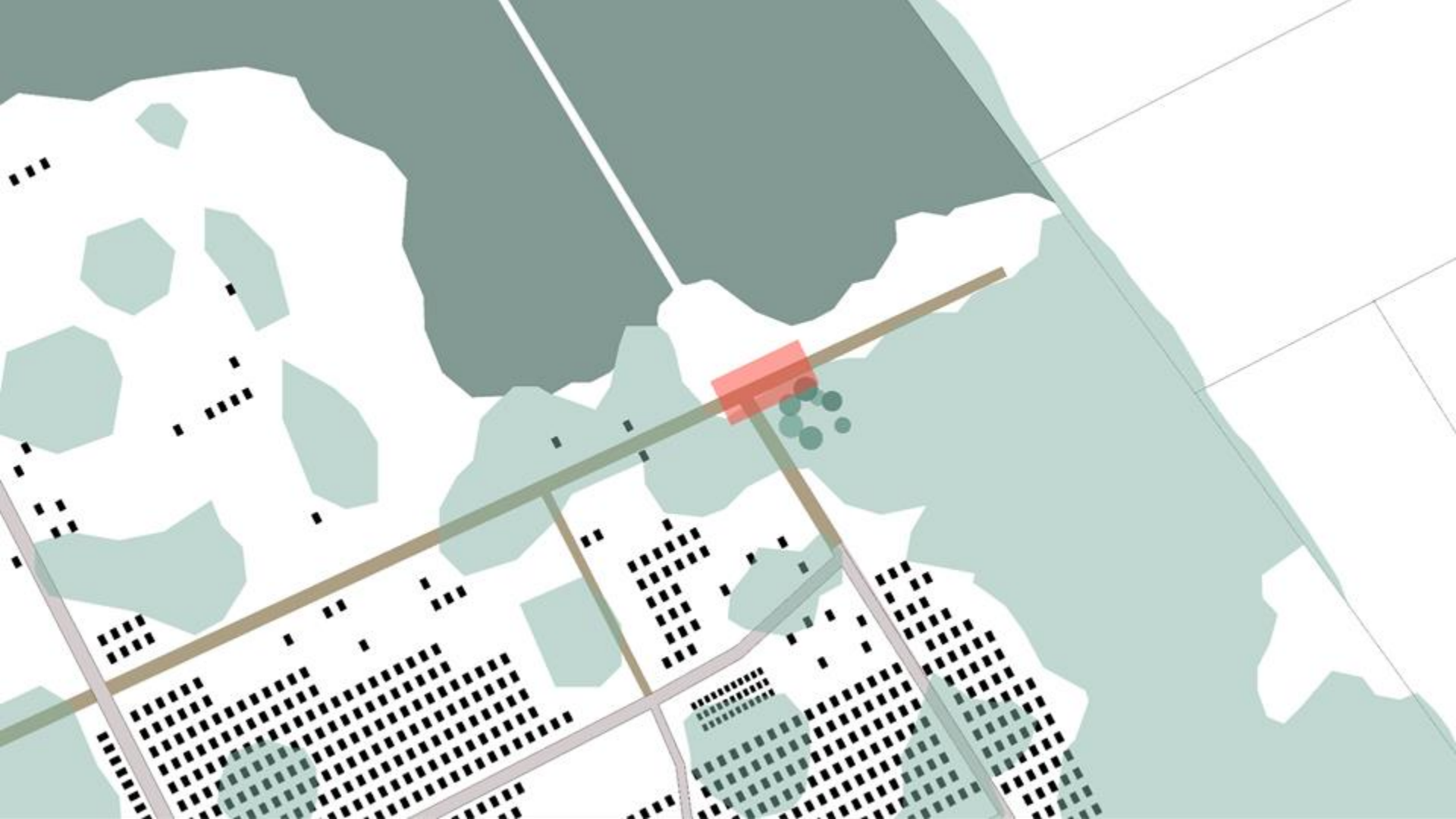

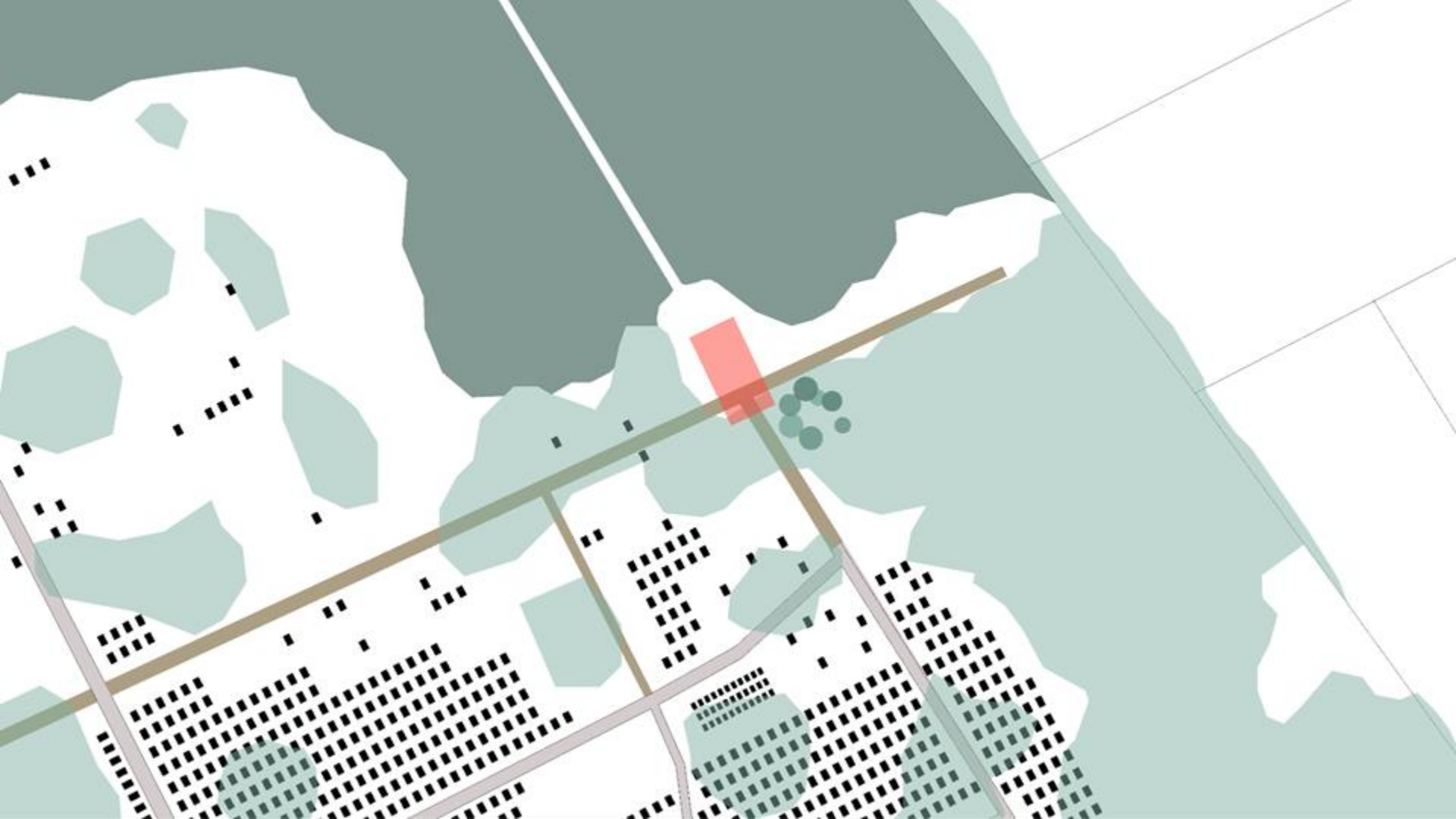



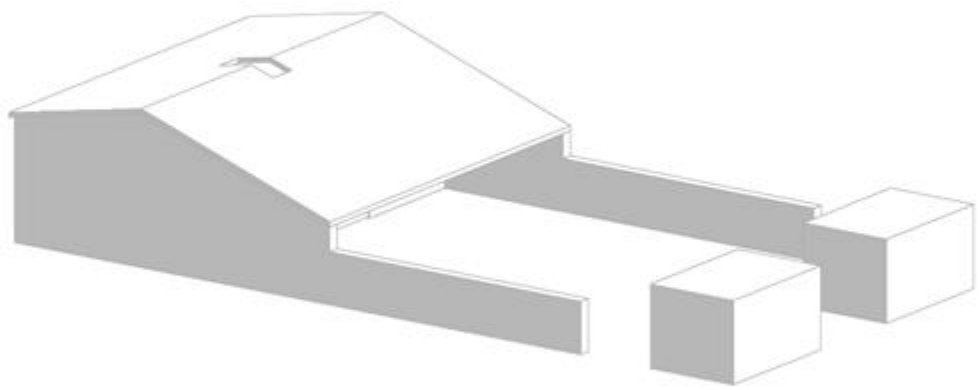

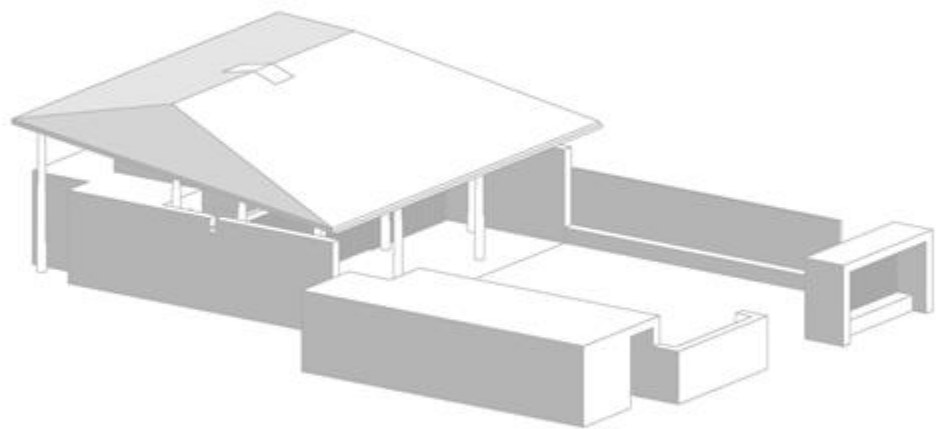

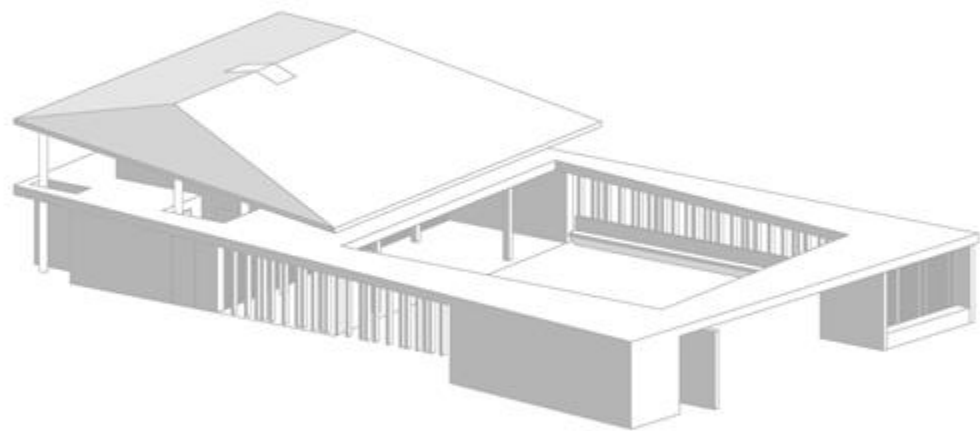

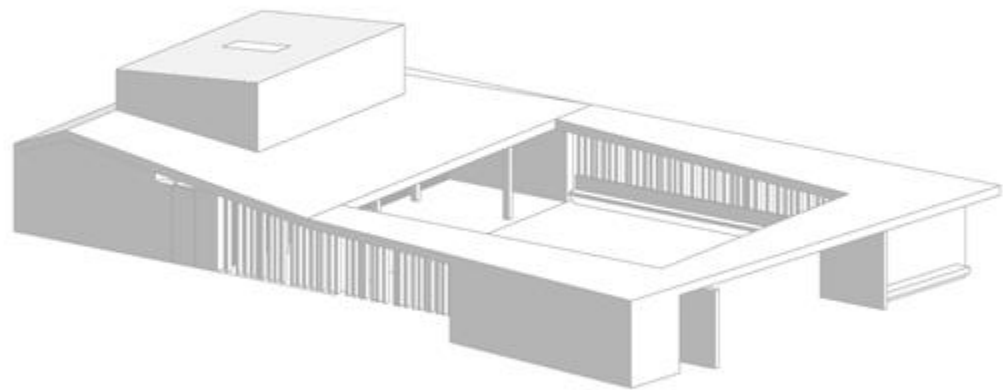

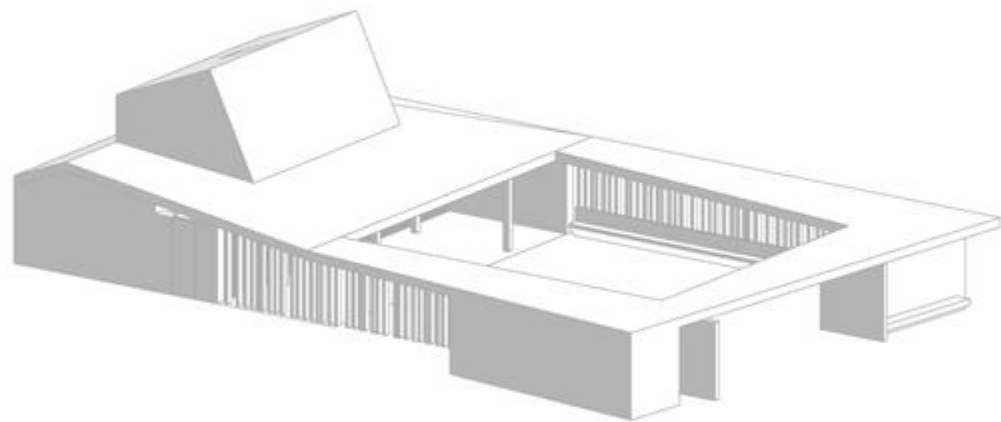

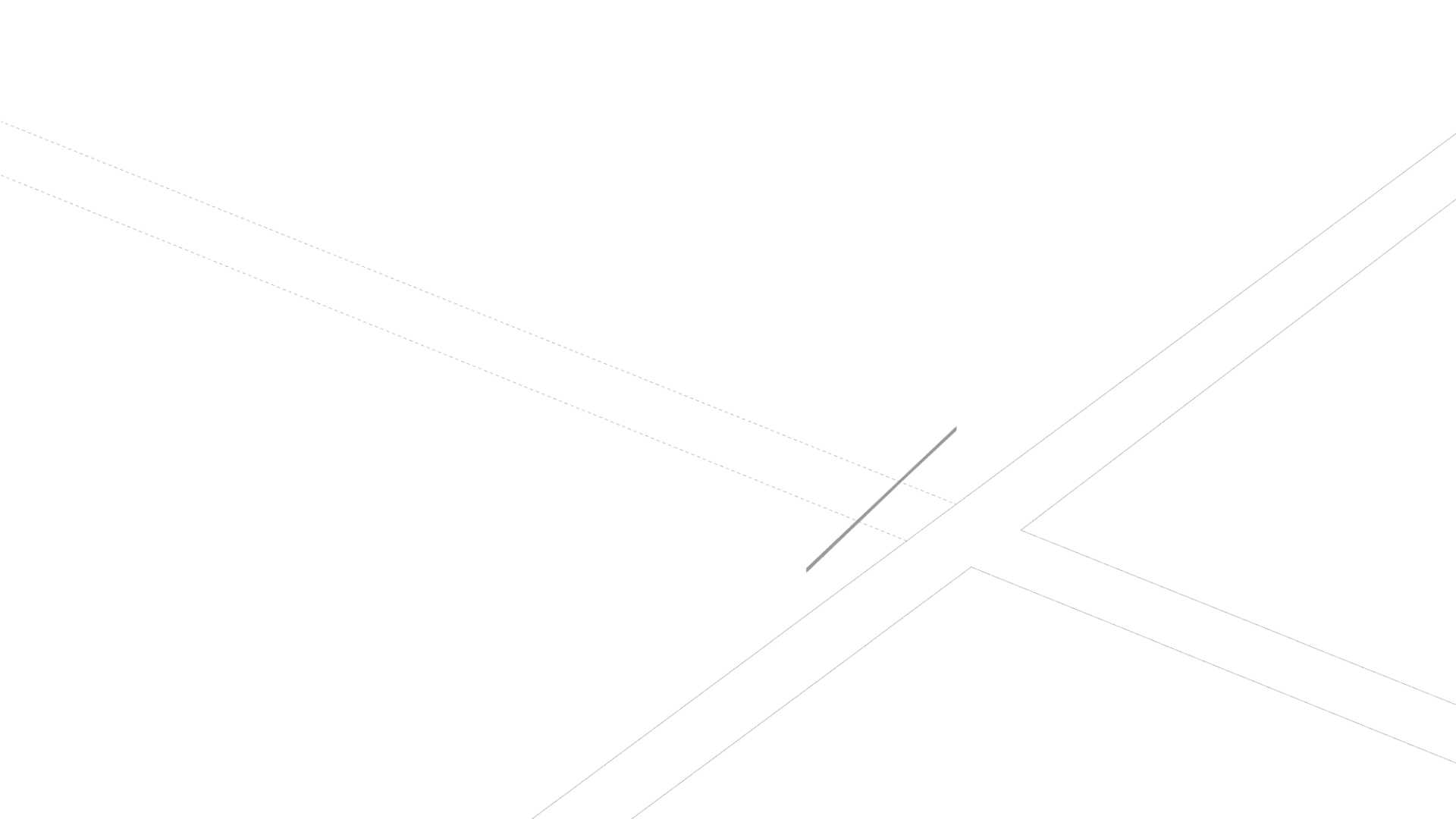

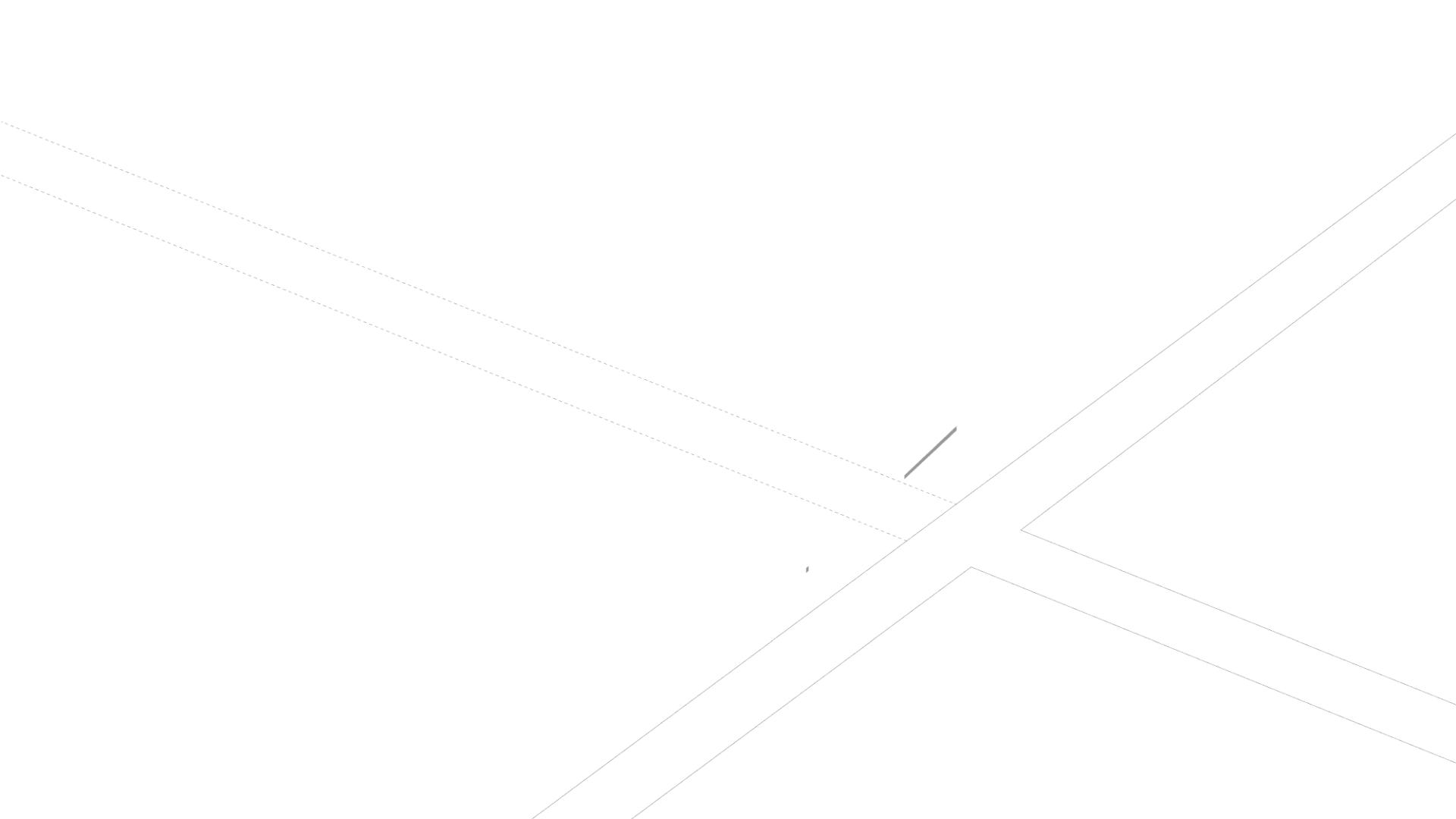

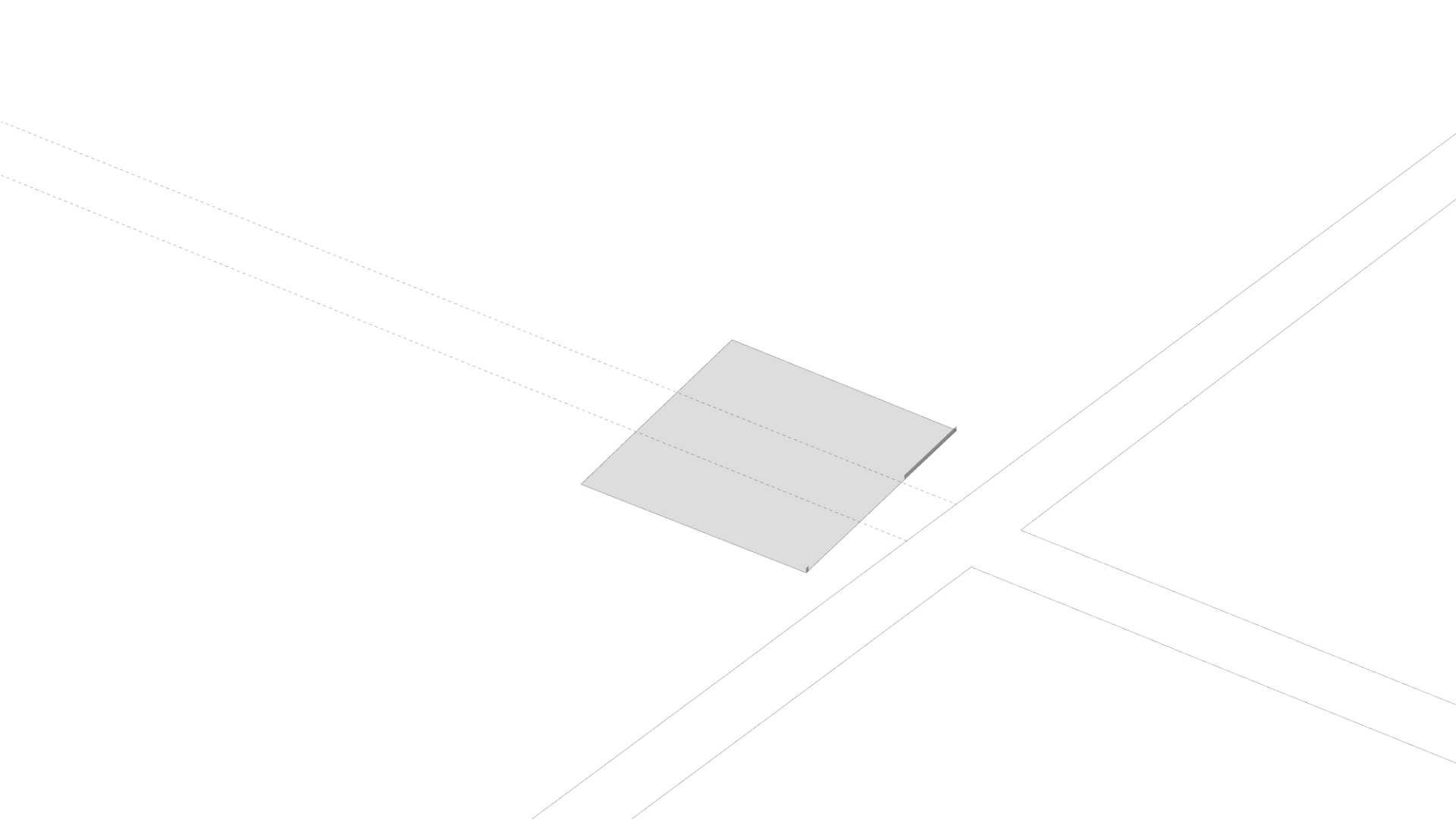

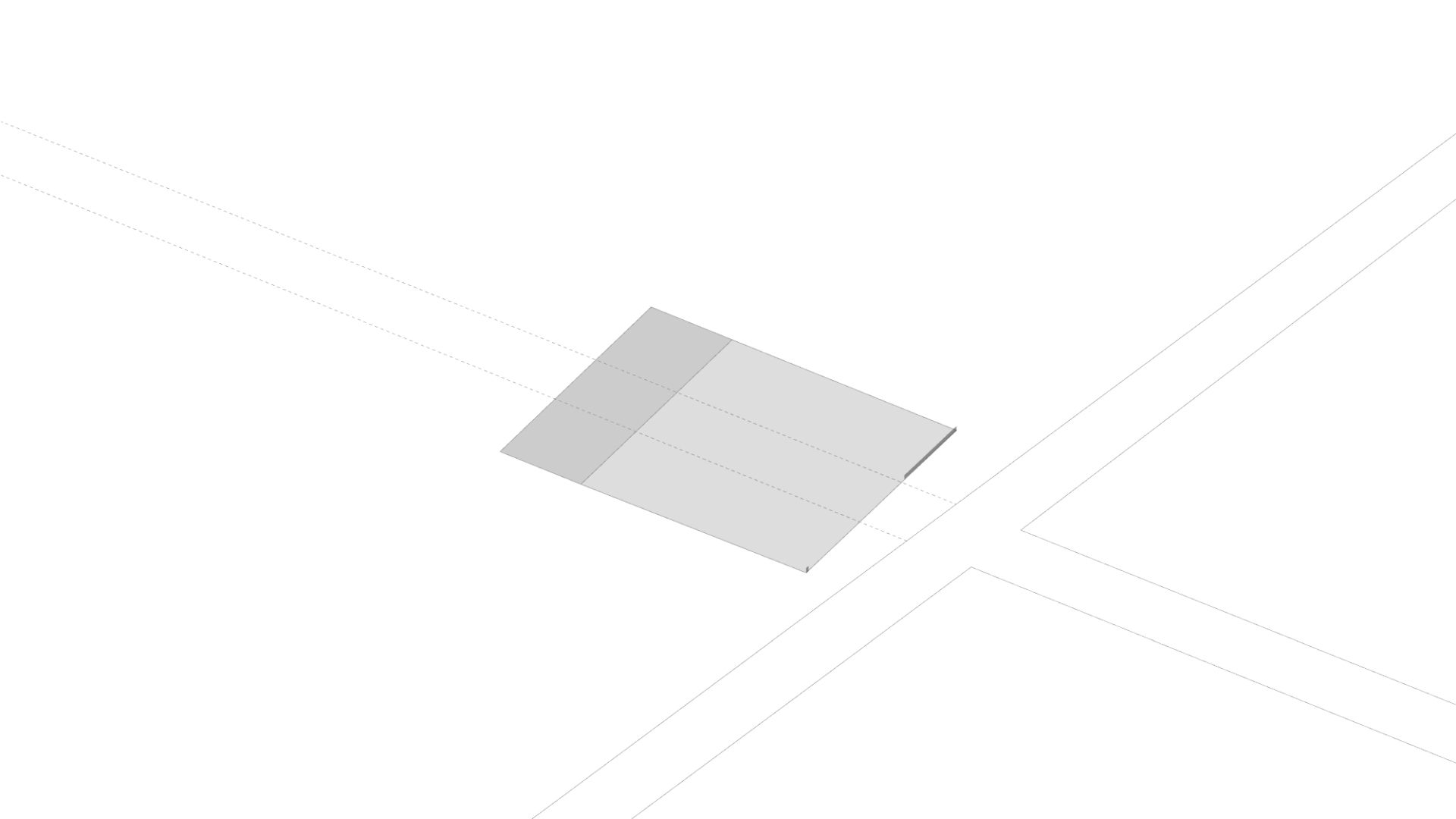

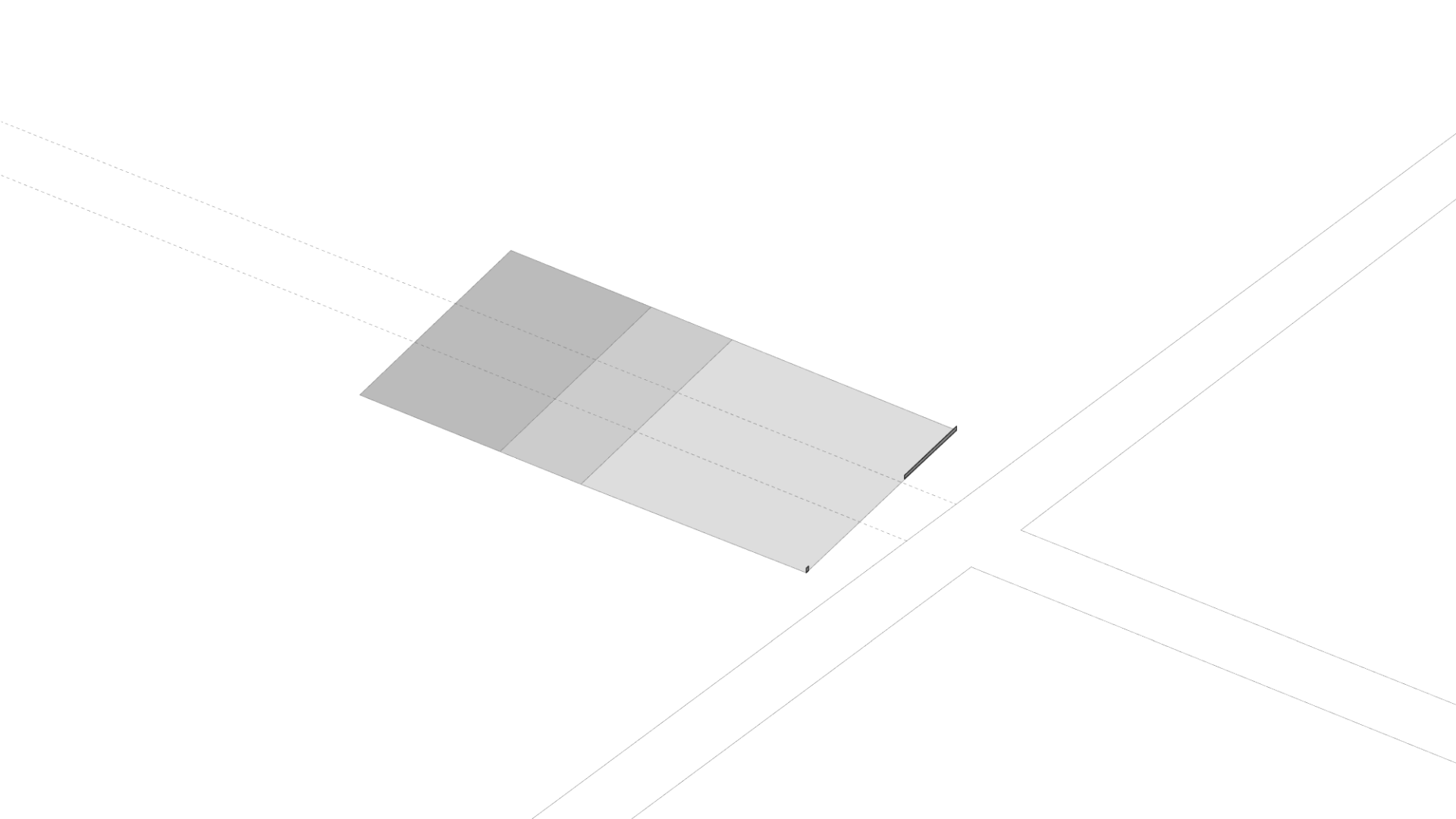

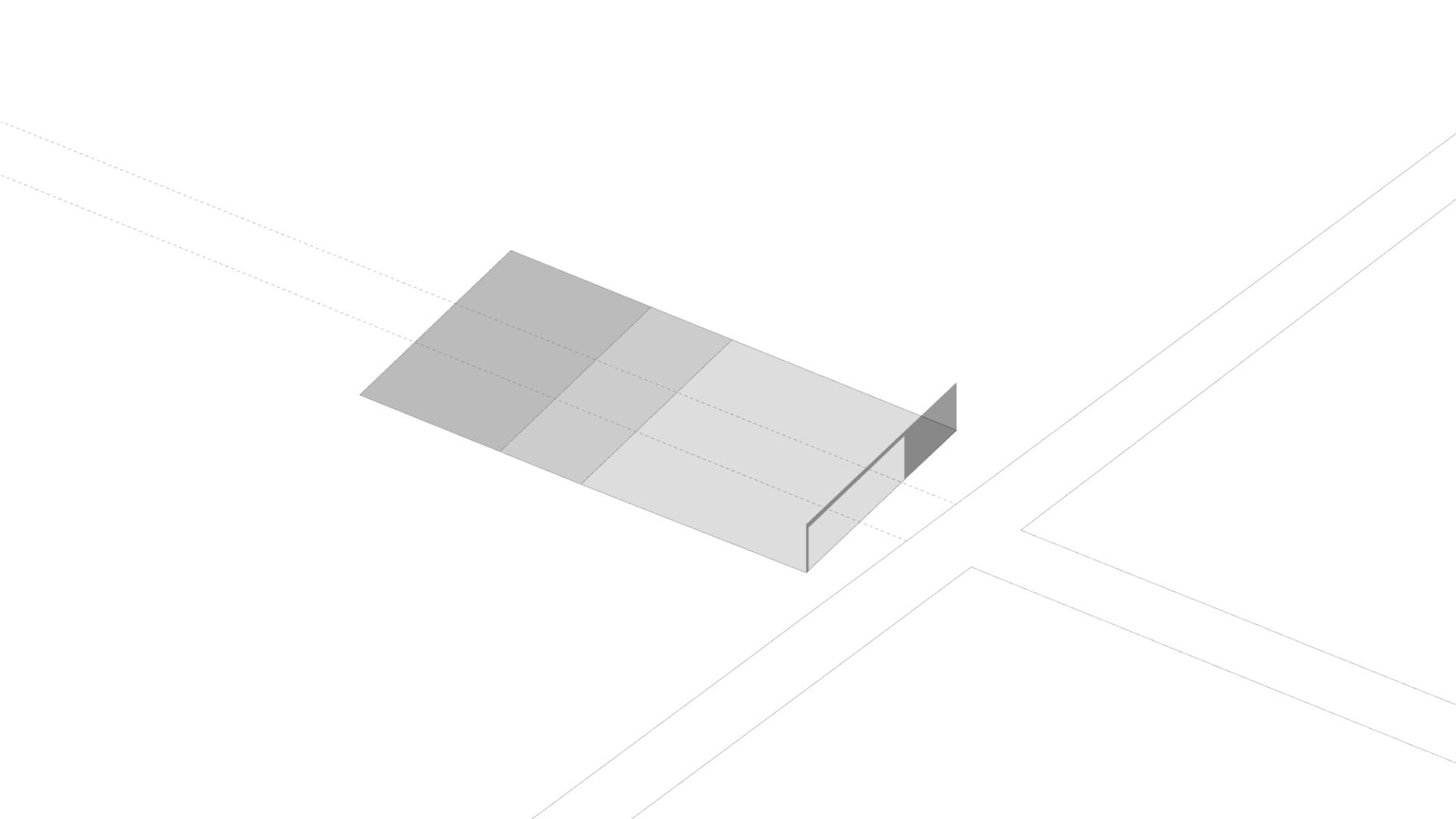

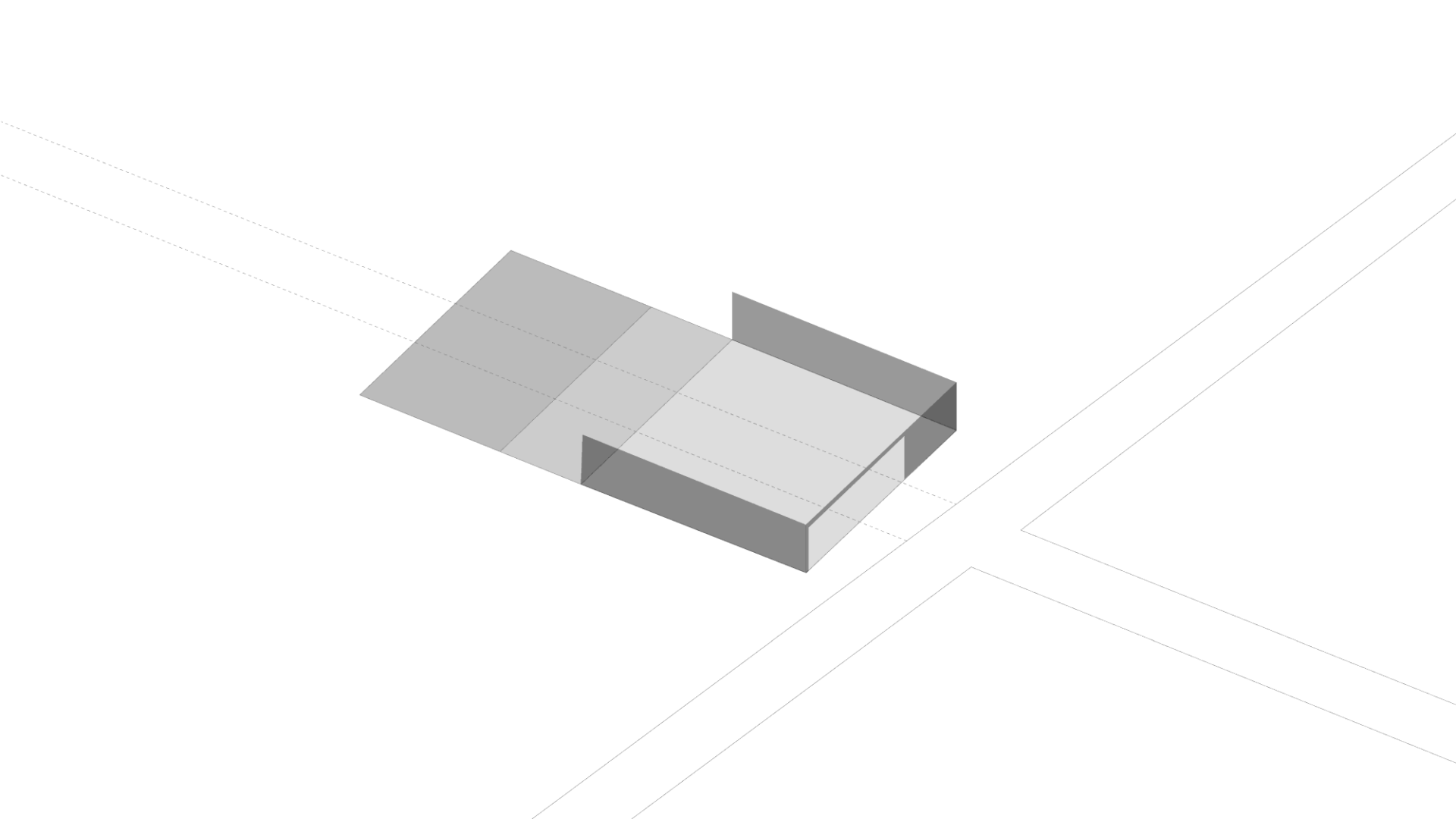

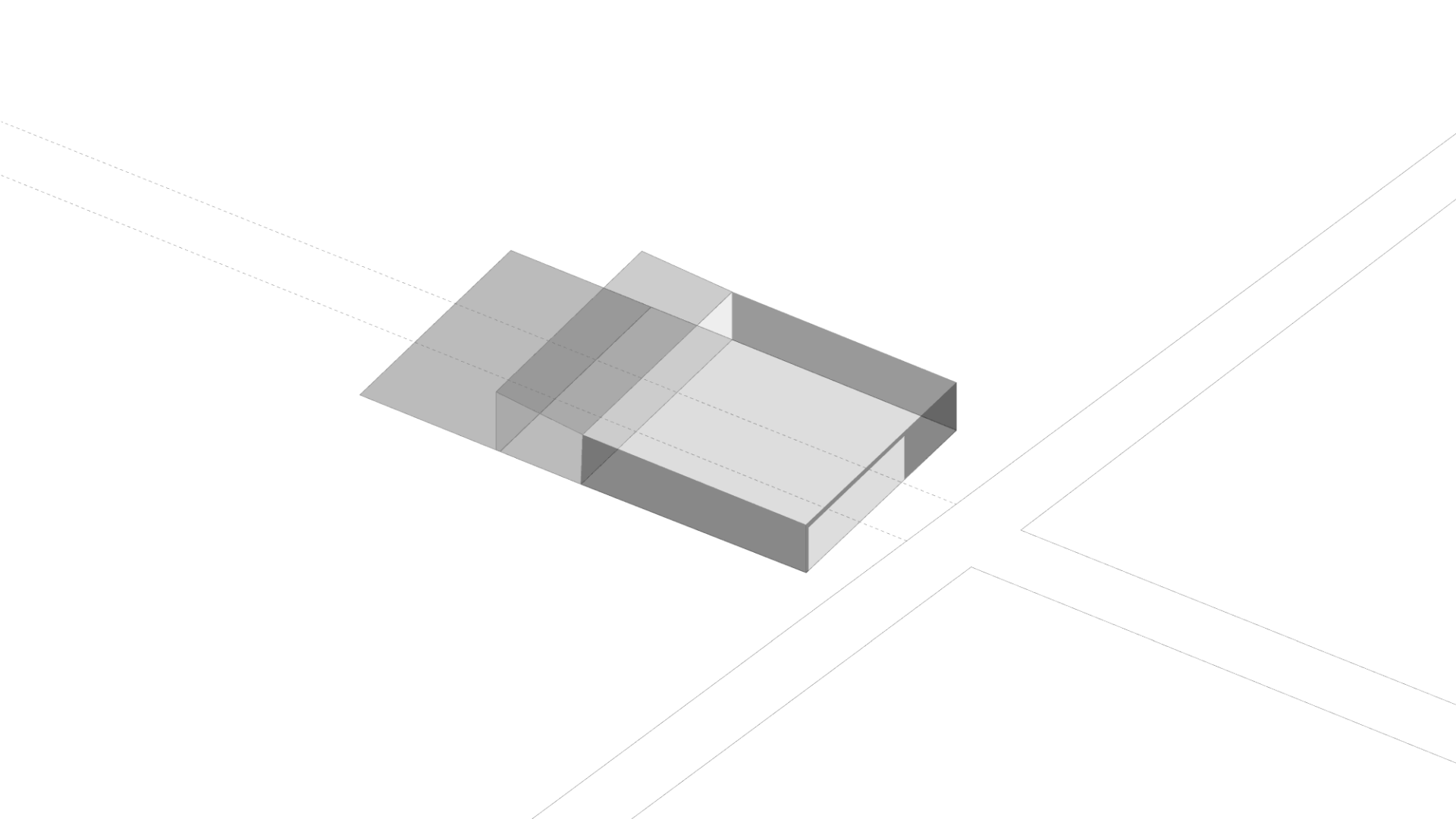

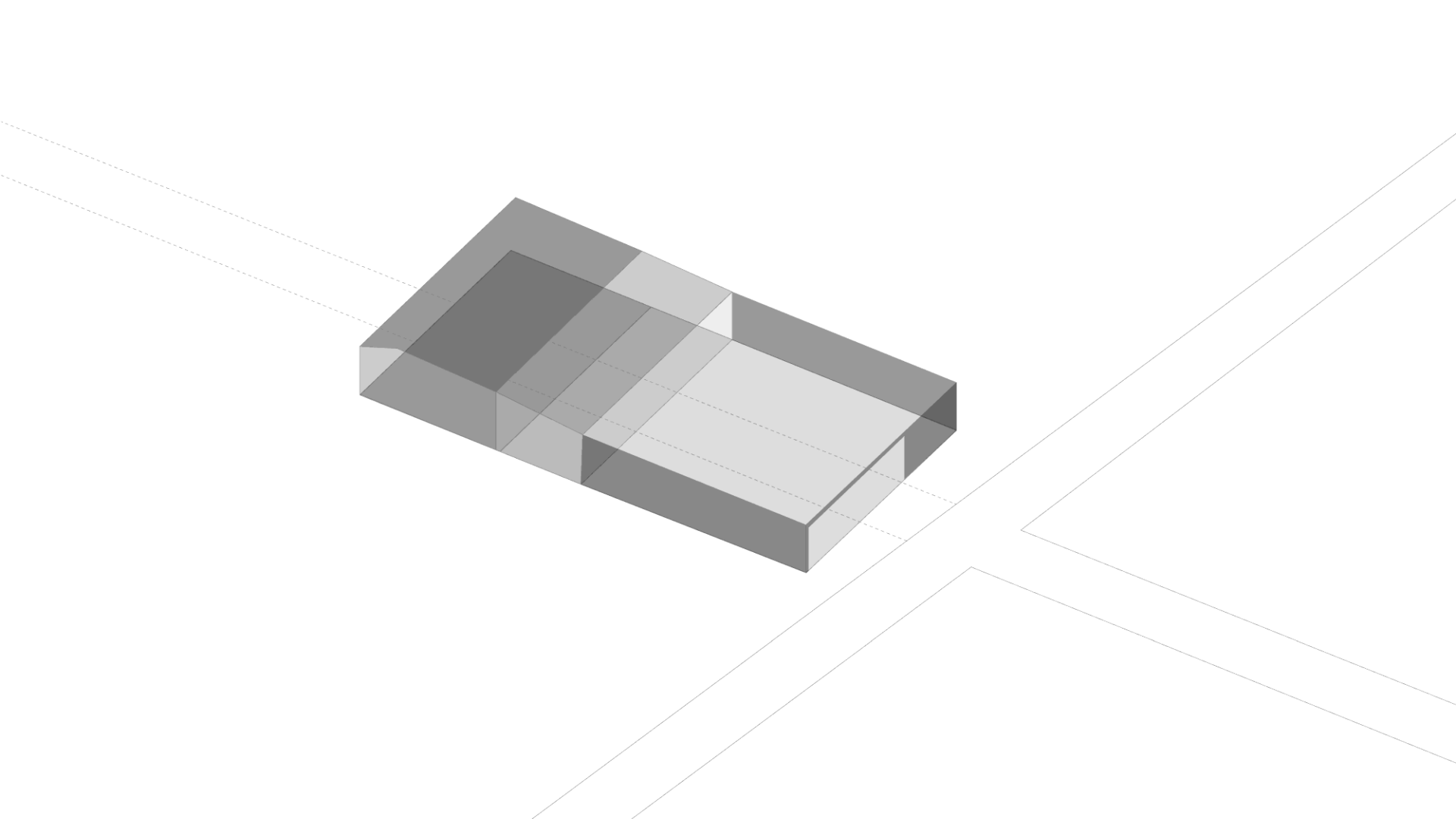

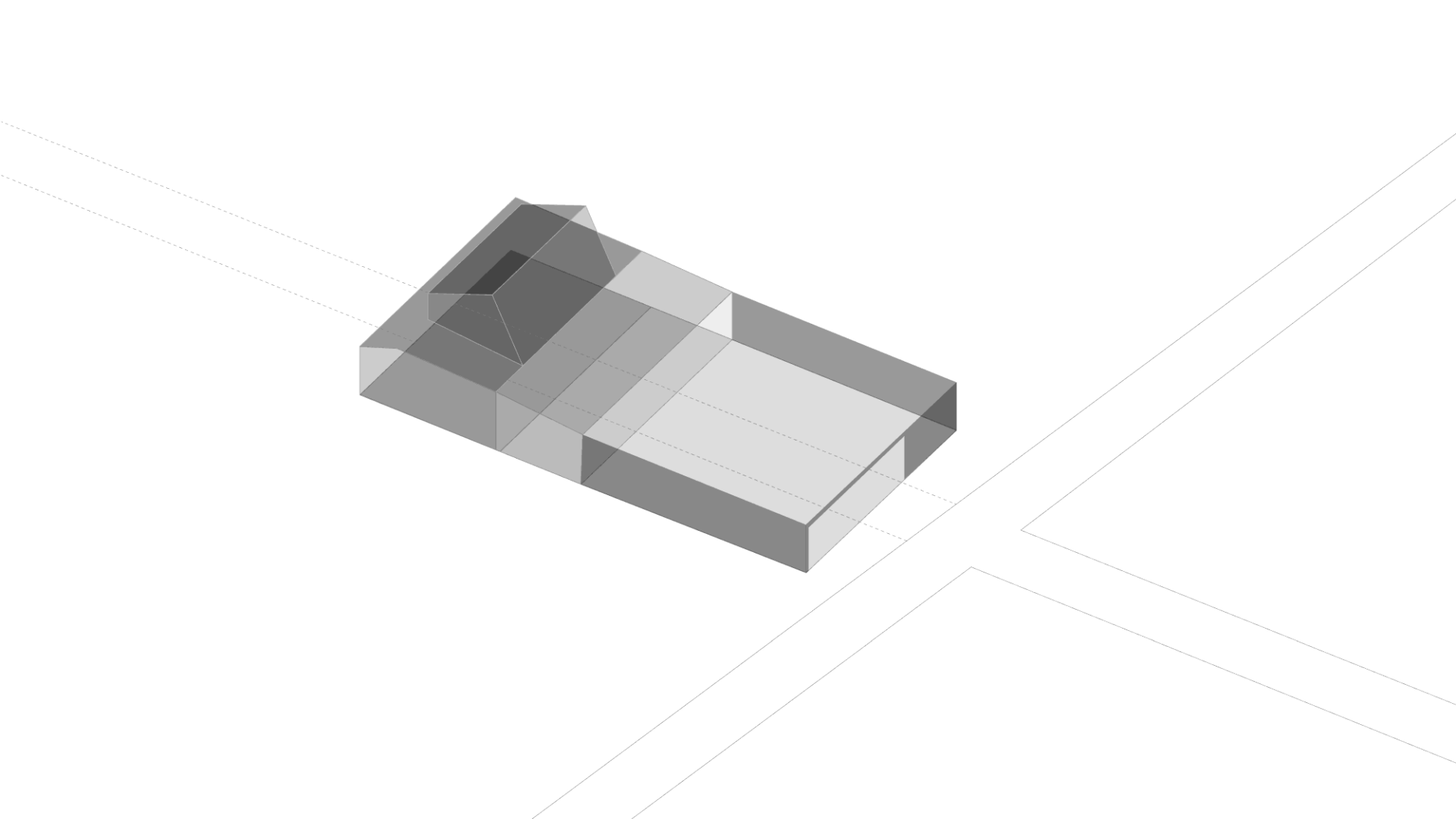

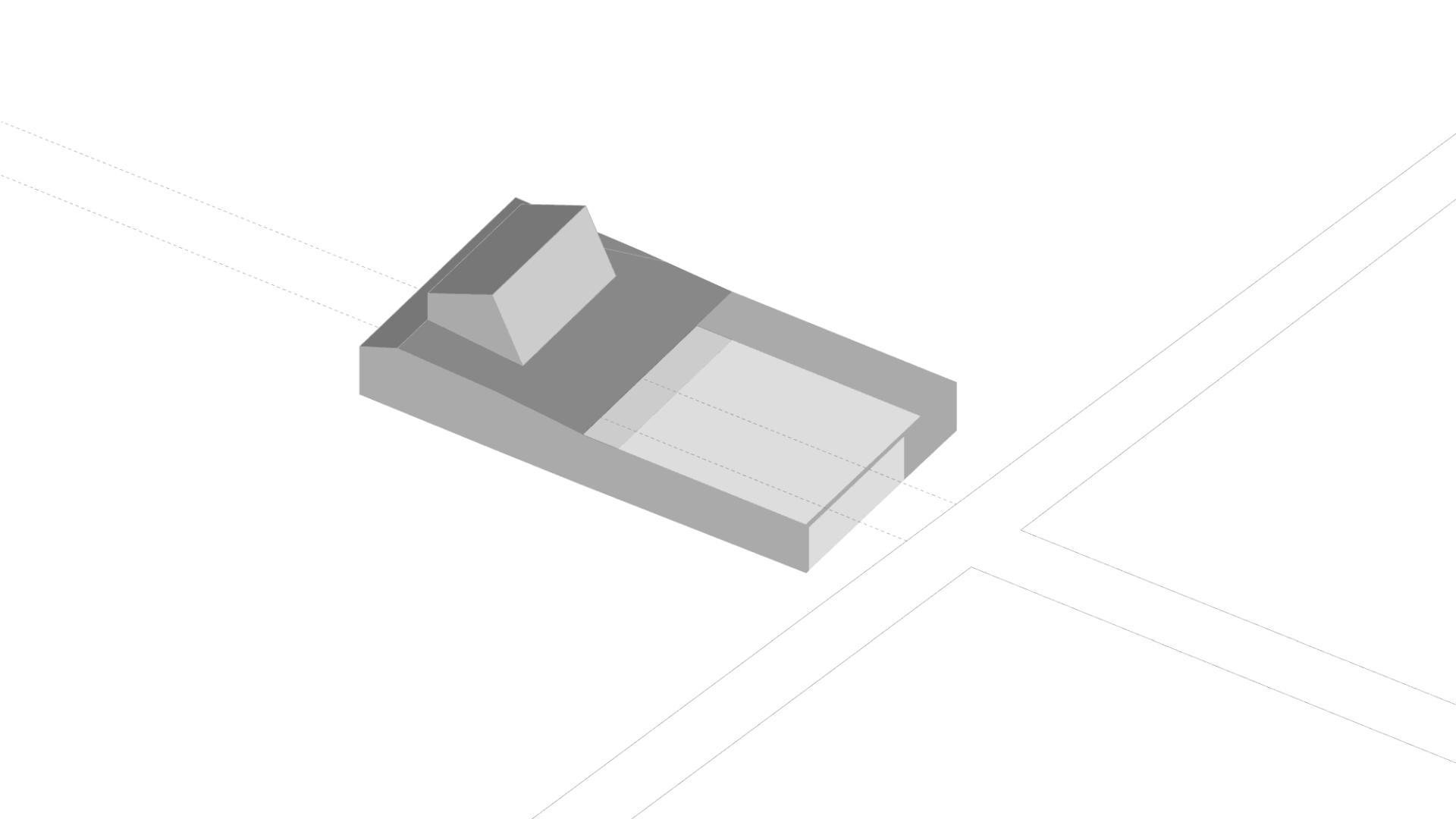

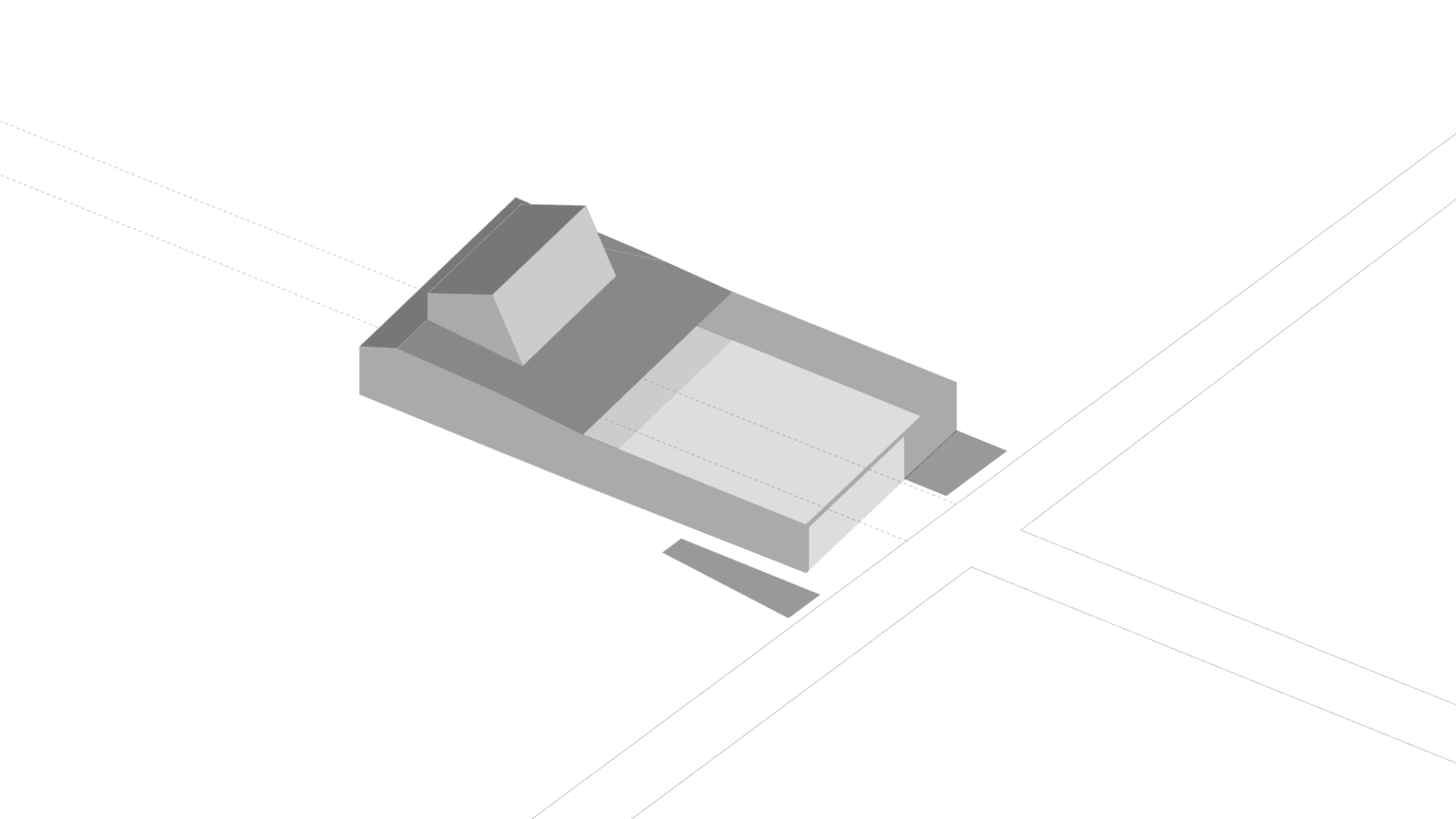

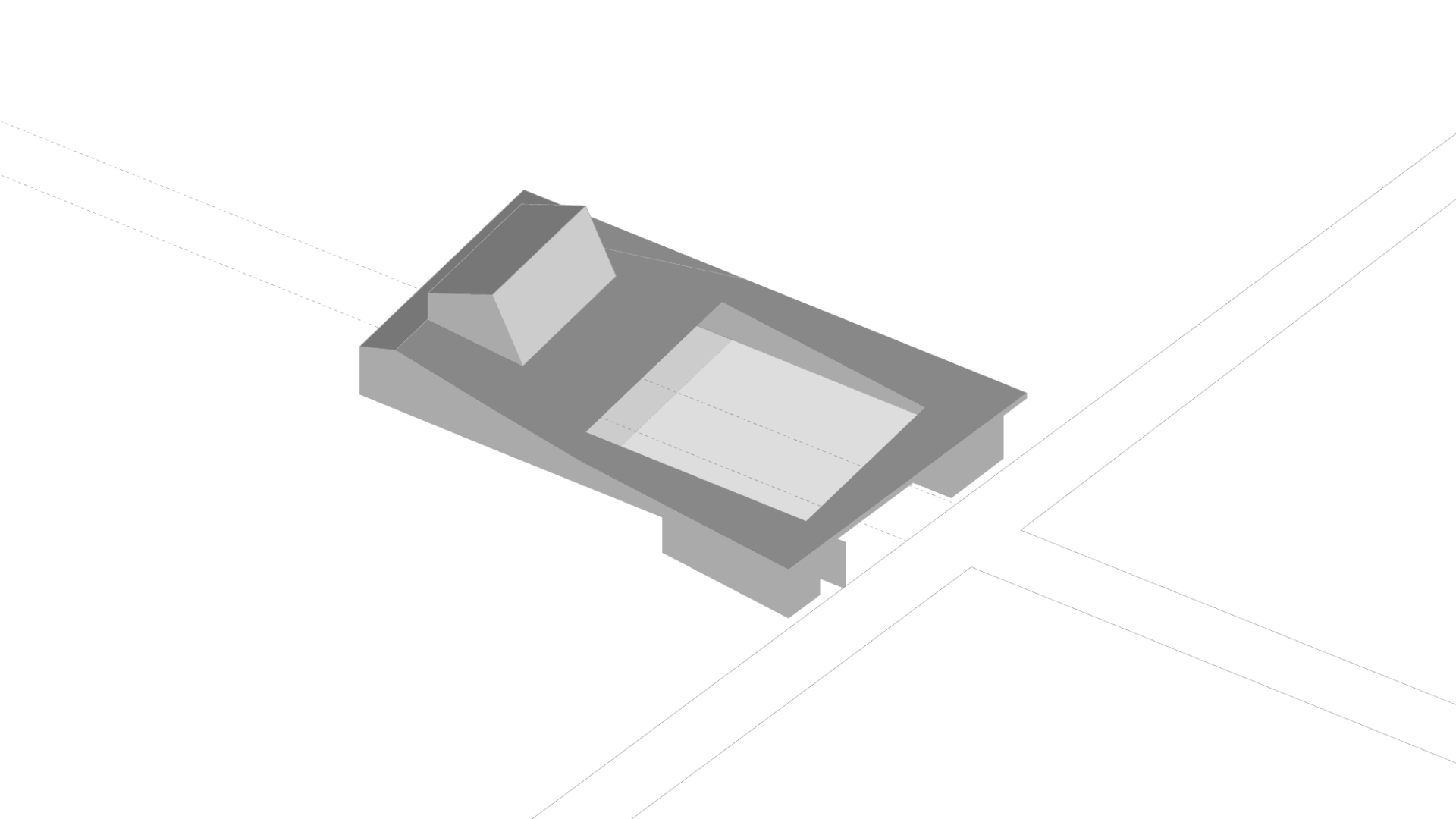

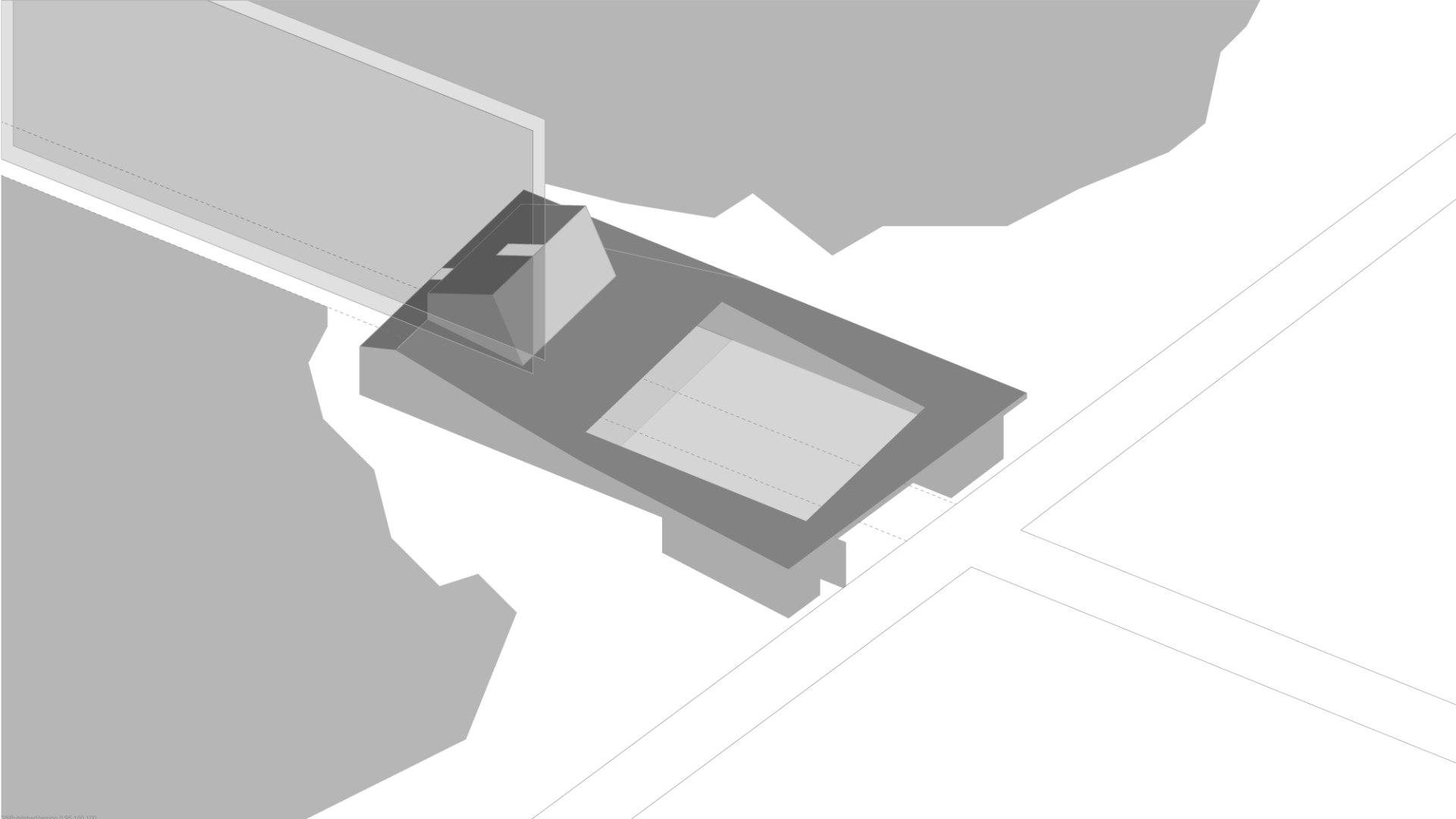

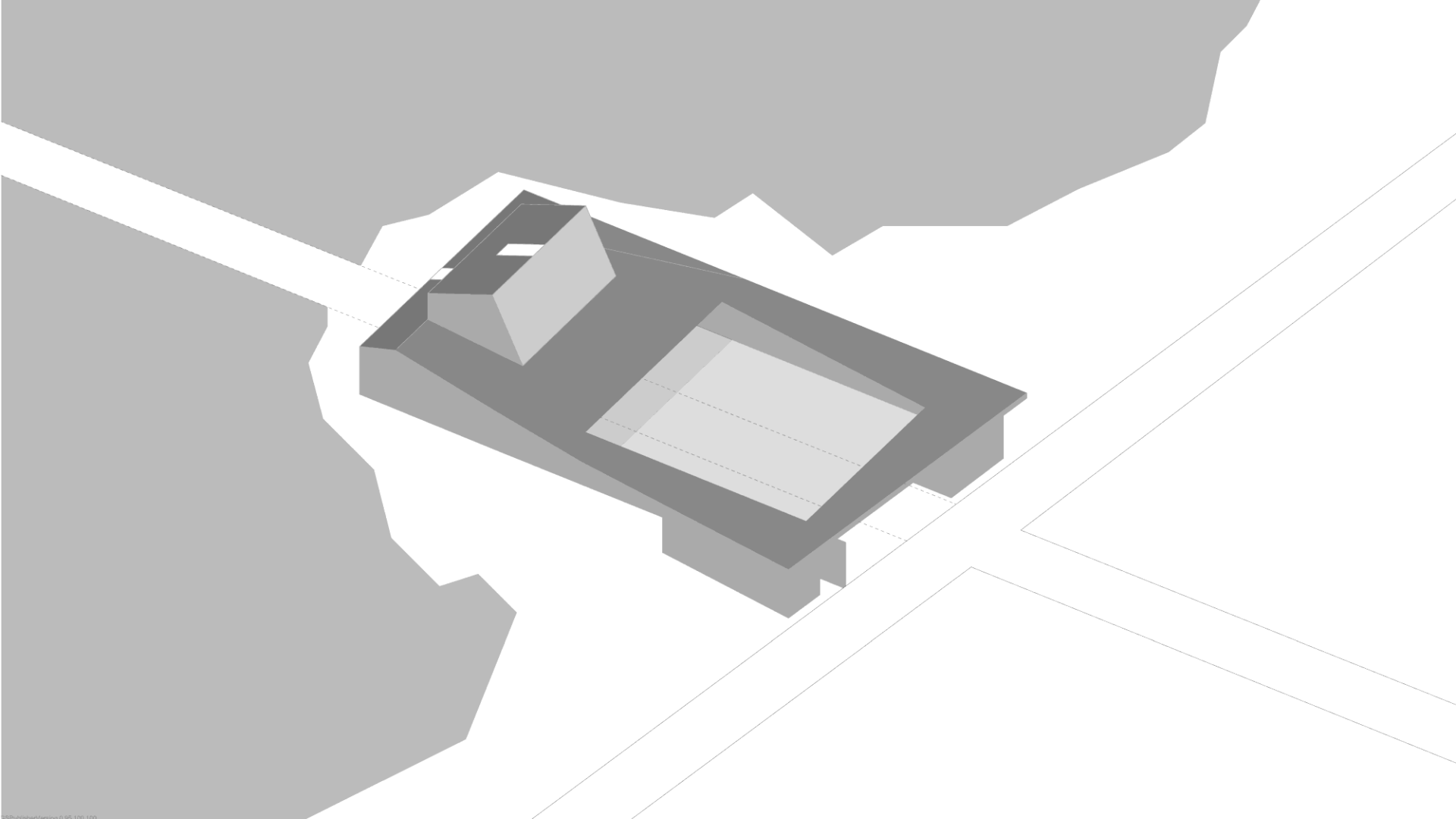



TELEPÍTETT ERDŐ

LIGETES
(TEMETŐ BŐVÍTÉSI LEHETŐSÉG)

TANUFÁK

BŐVÍTETT ÚT

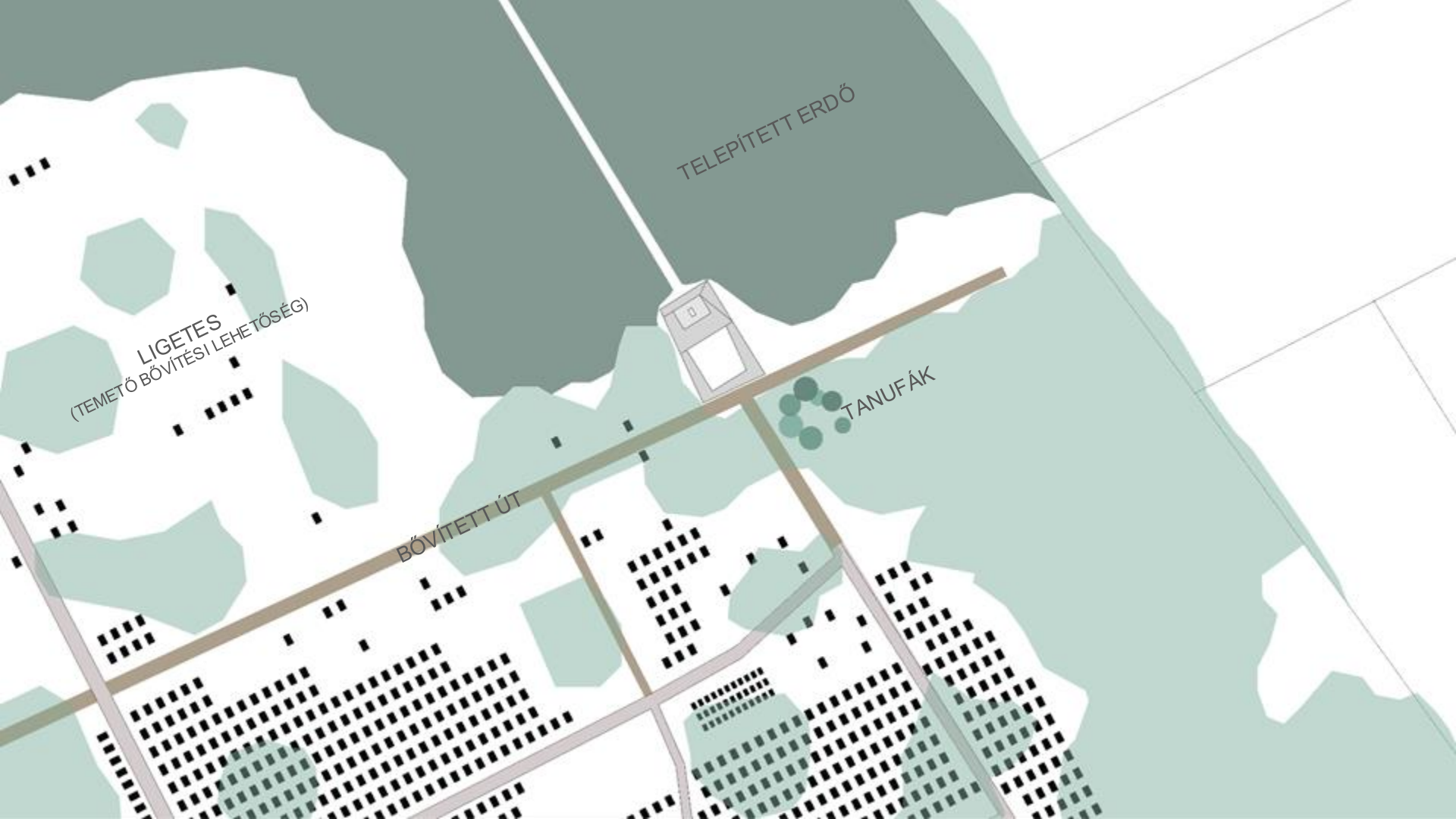

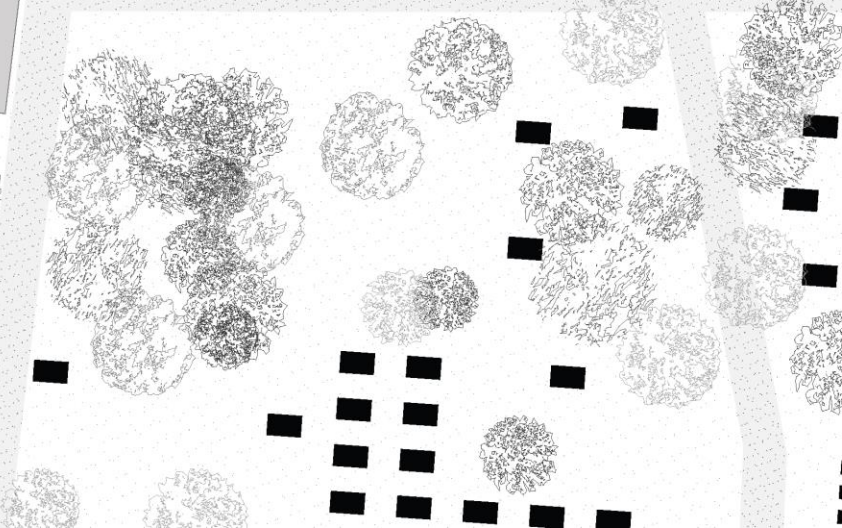
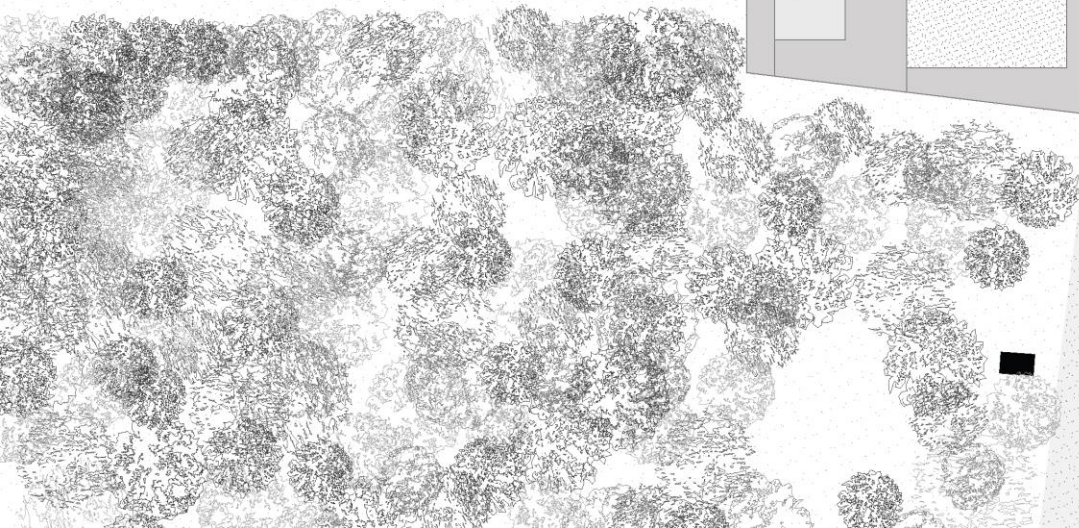
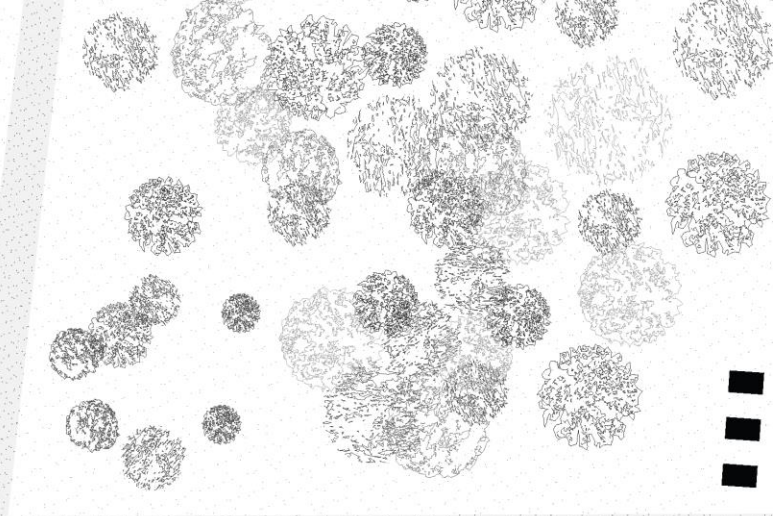
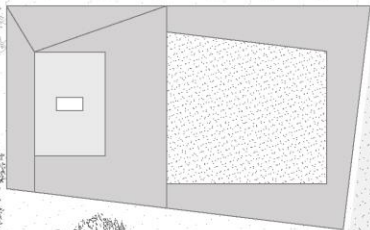
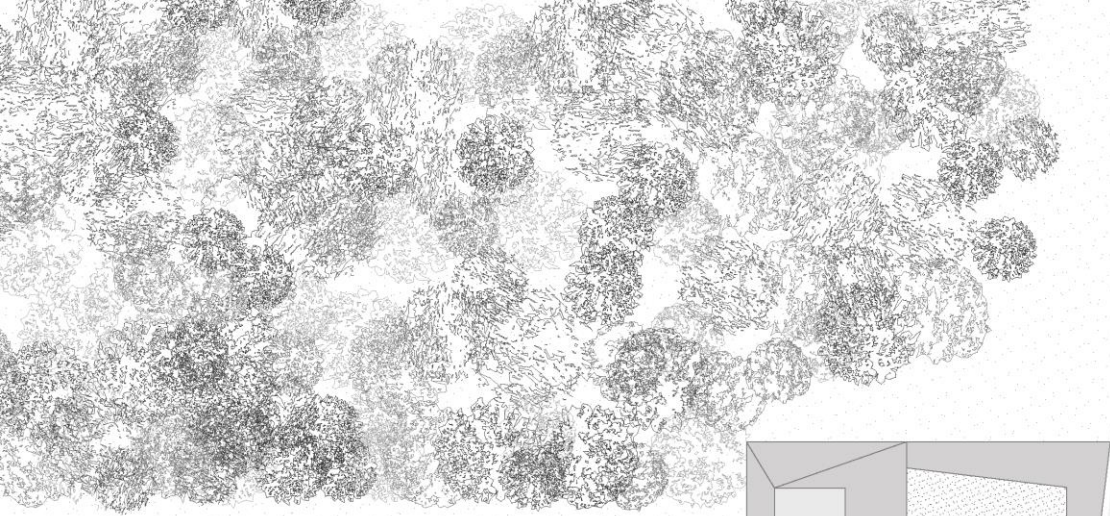

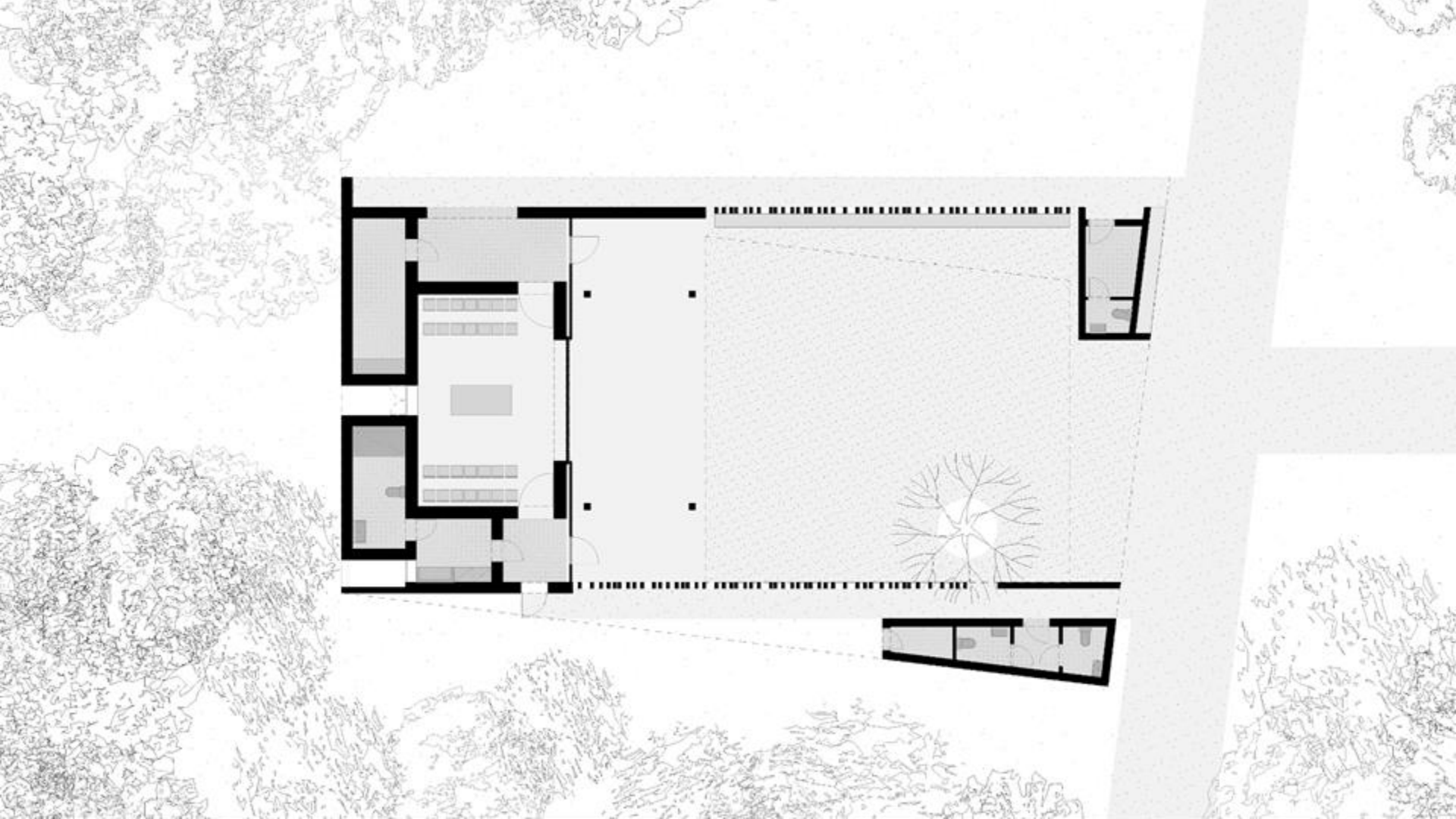

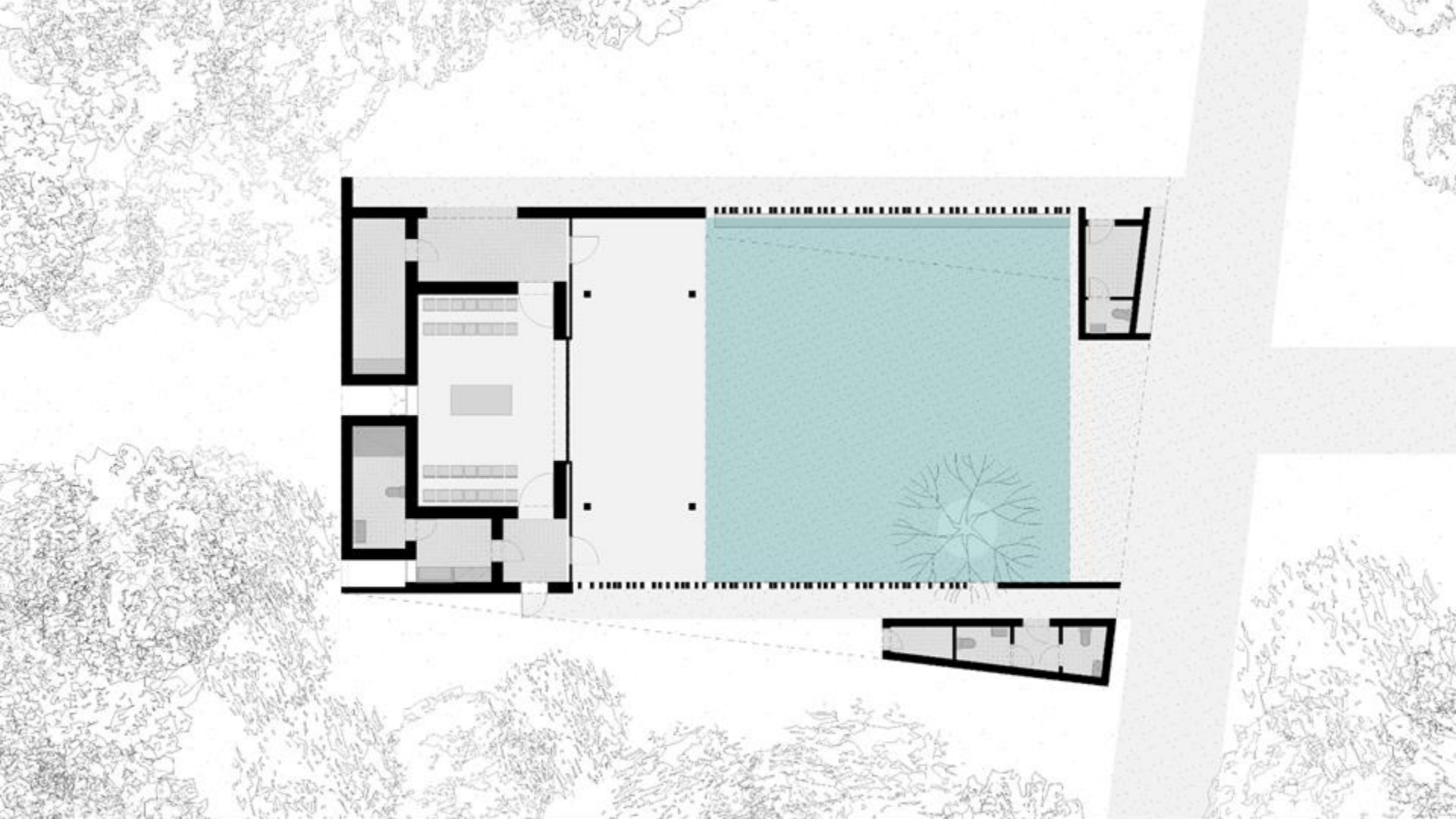

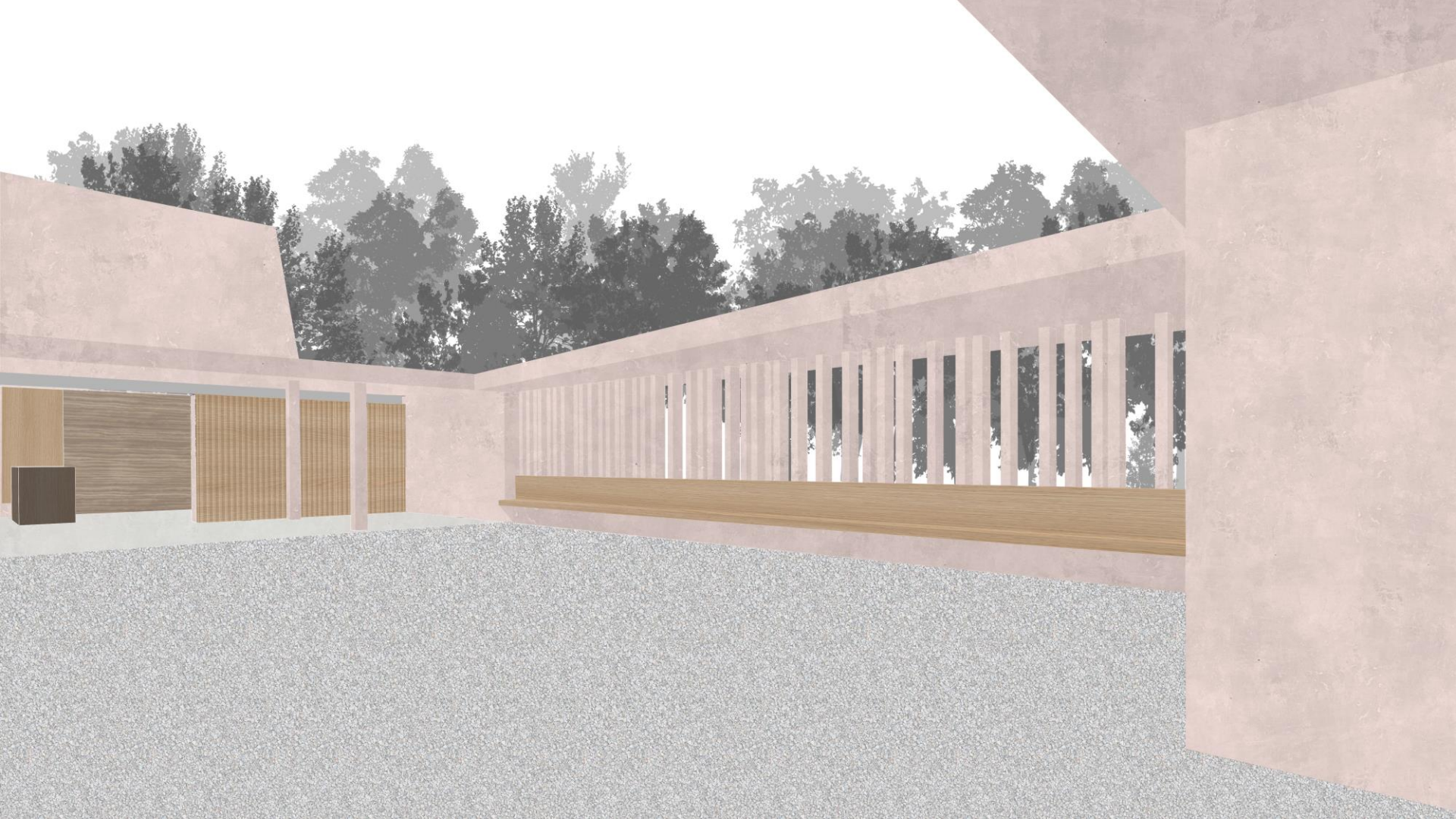

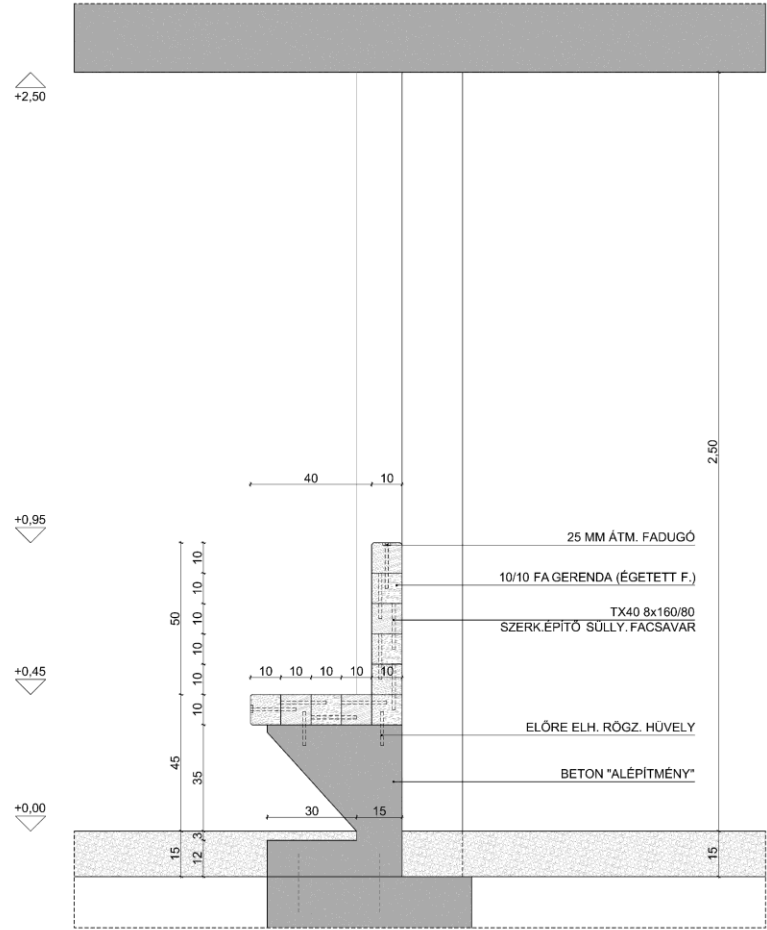
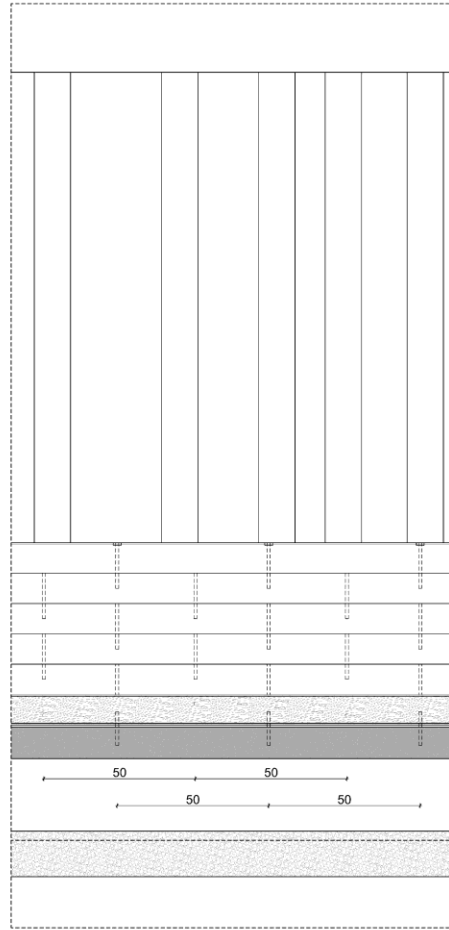
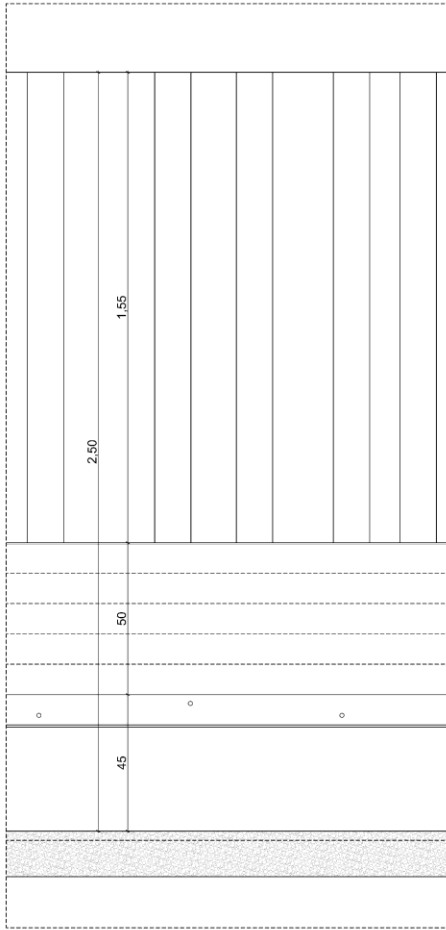

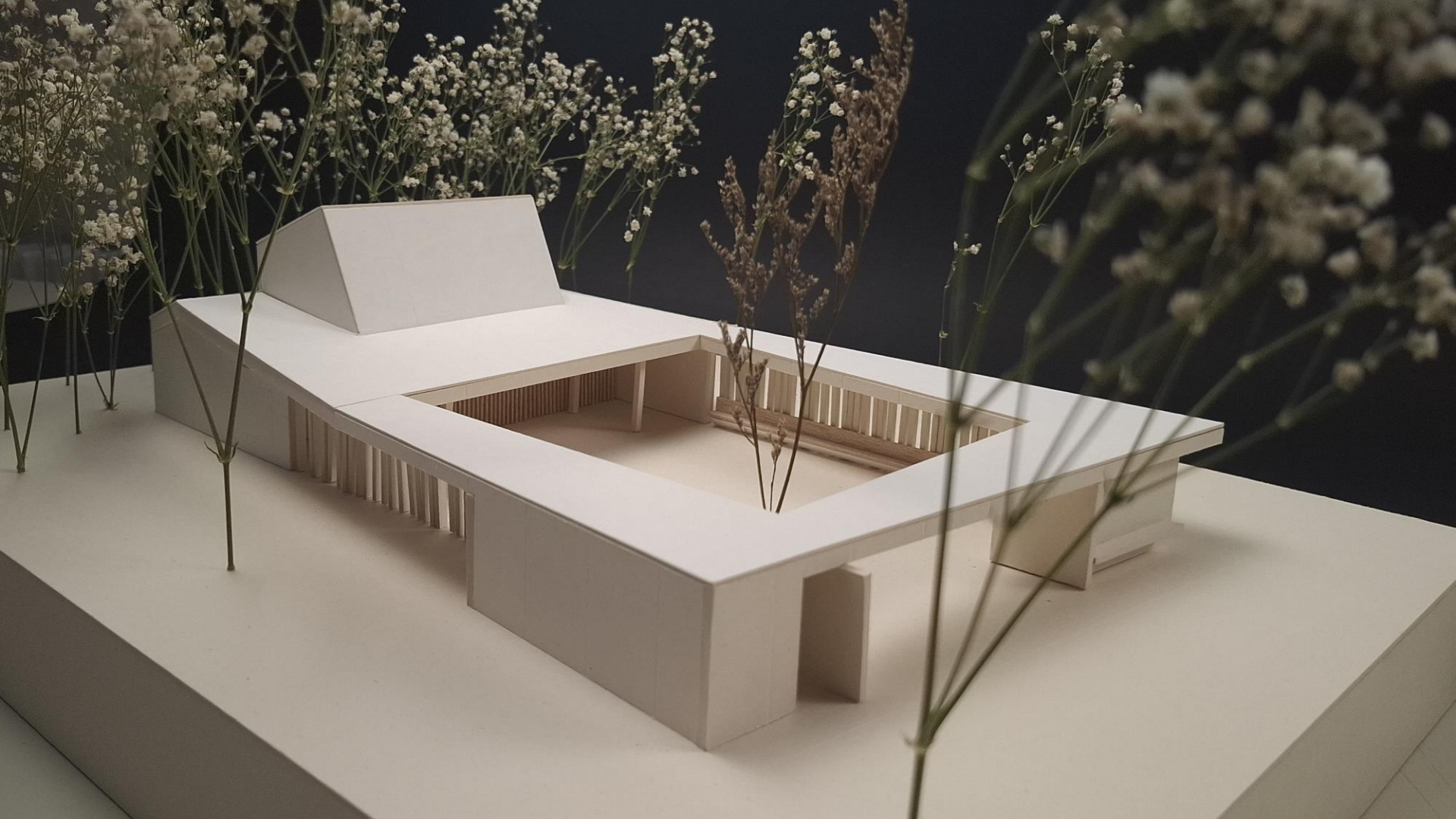

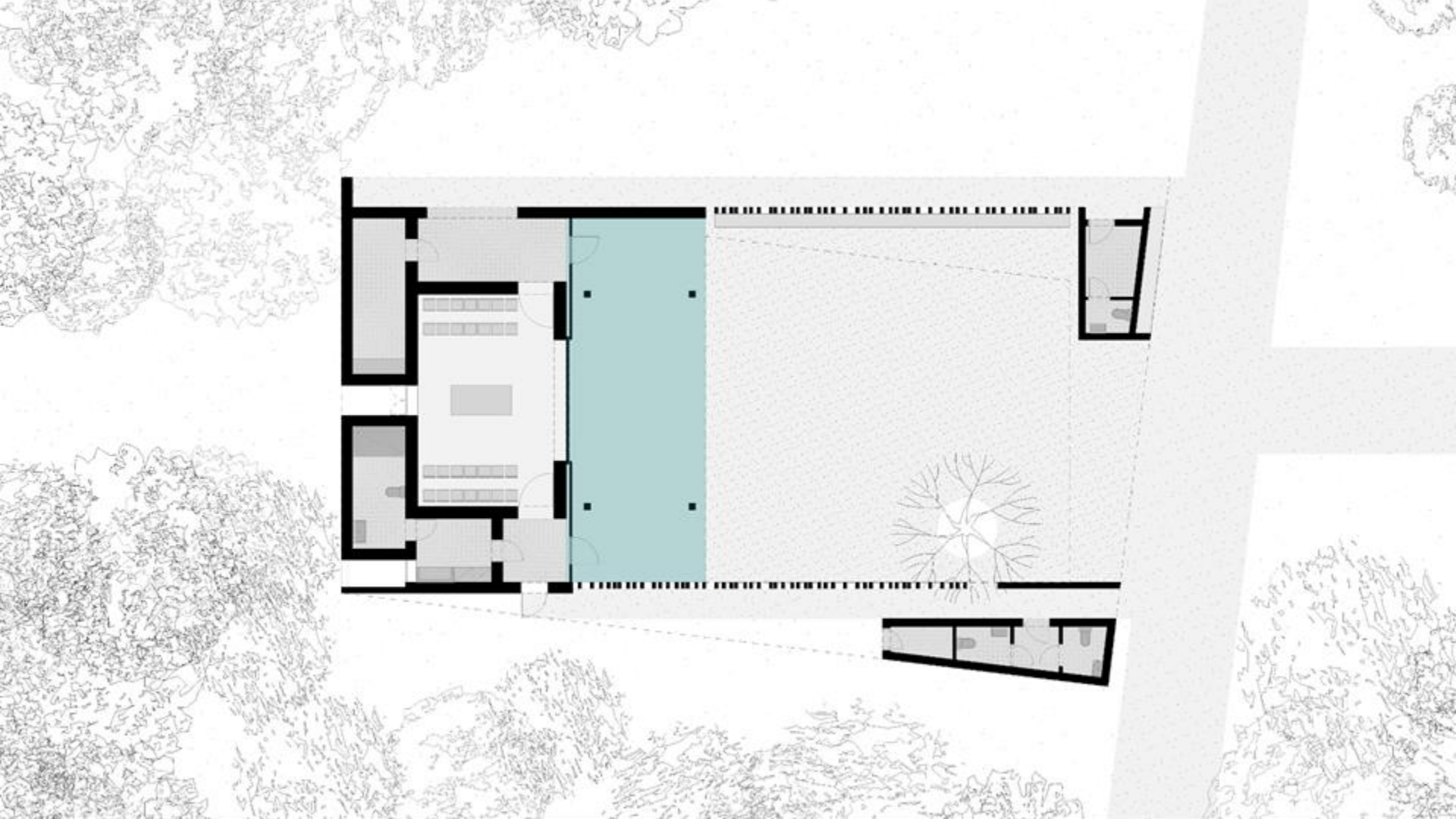

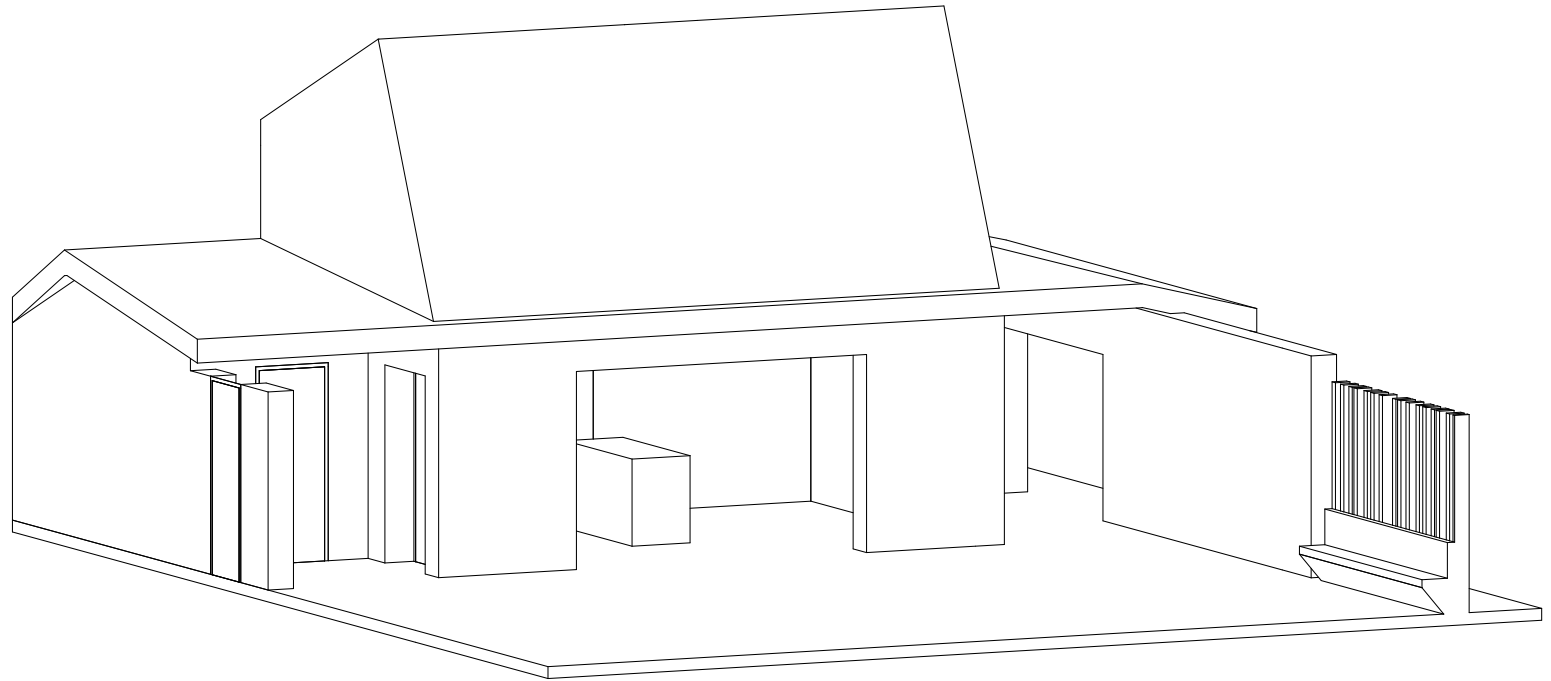

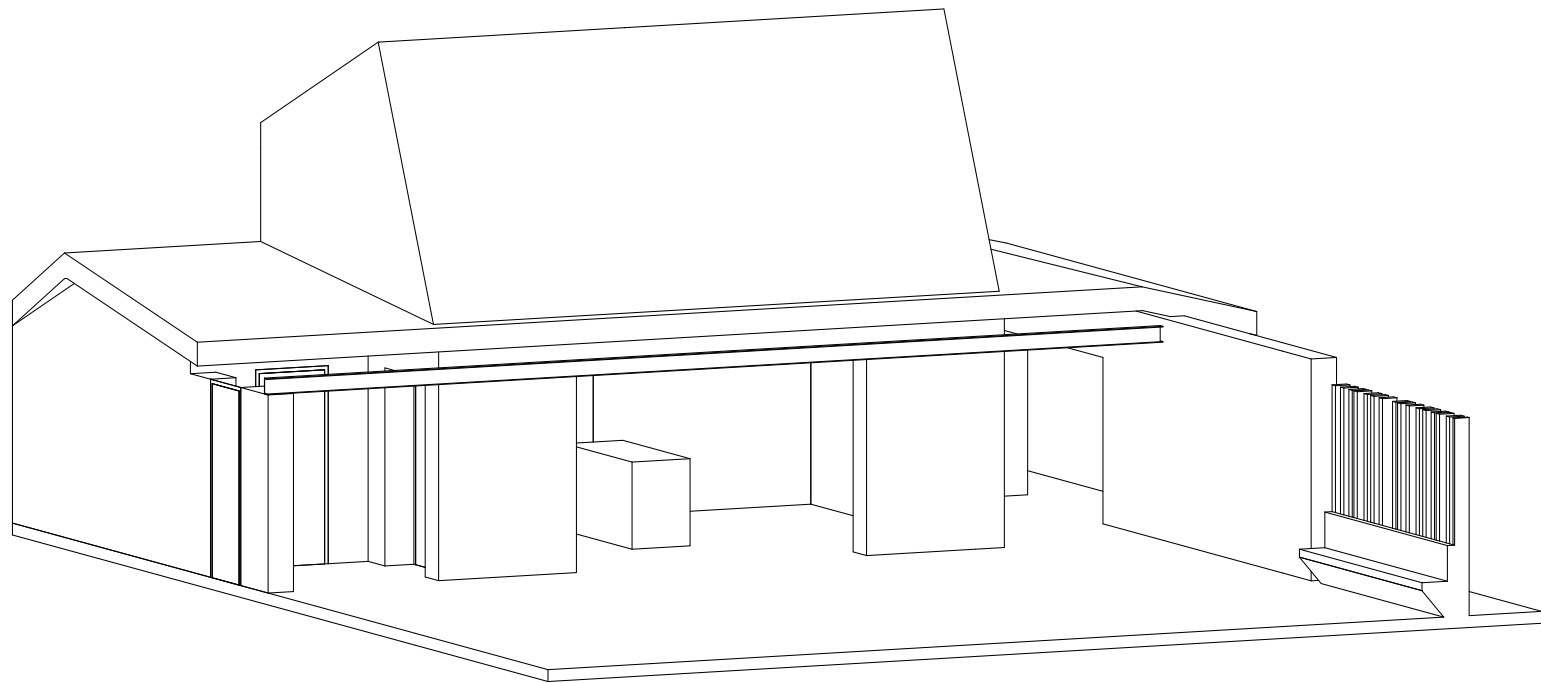

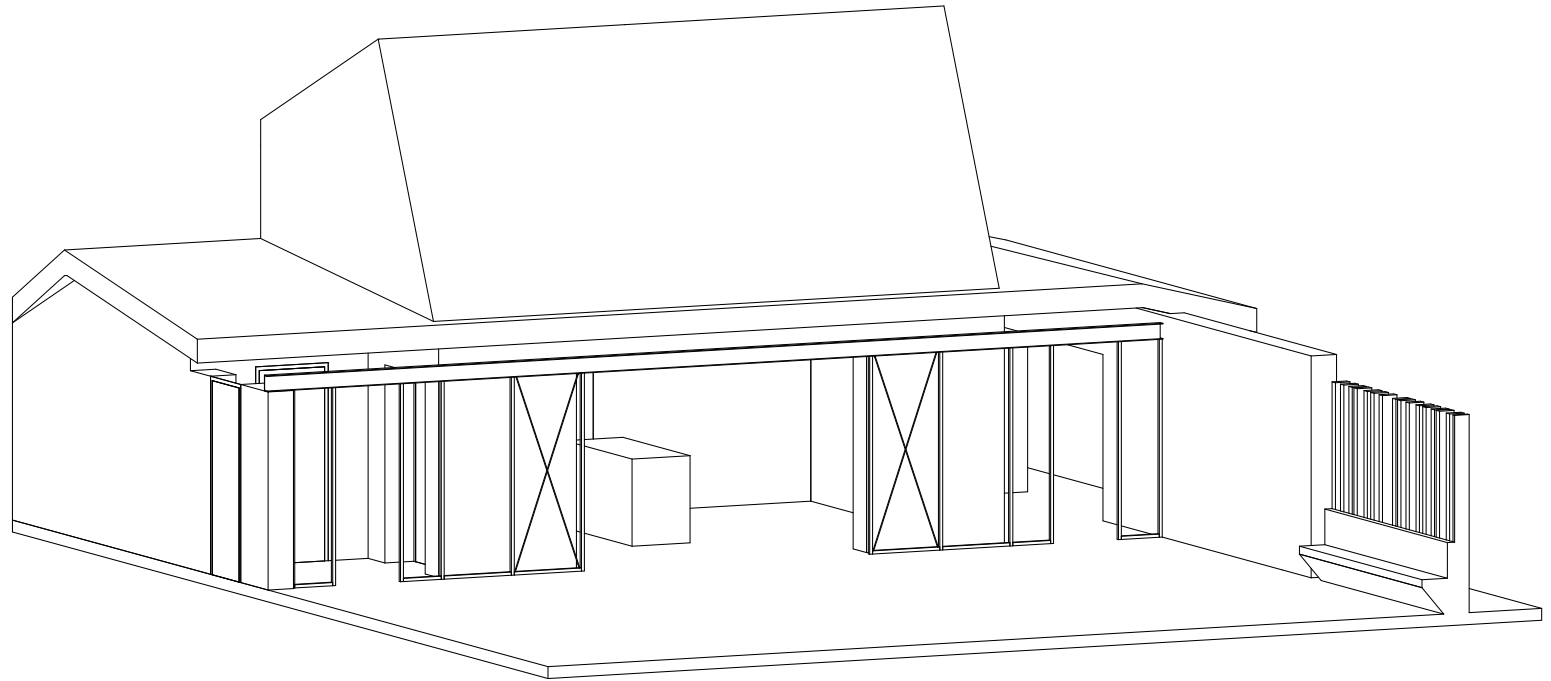

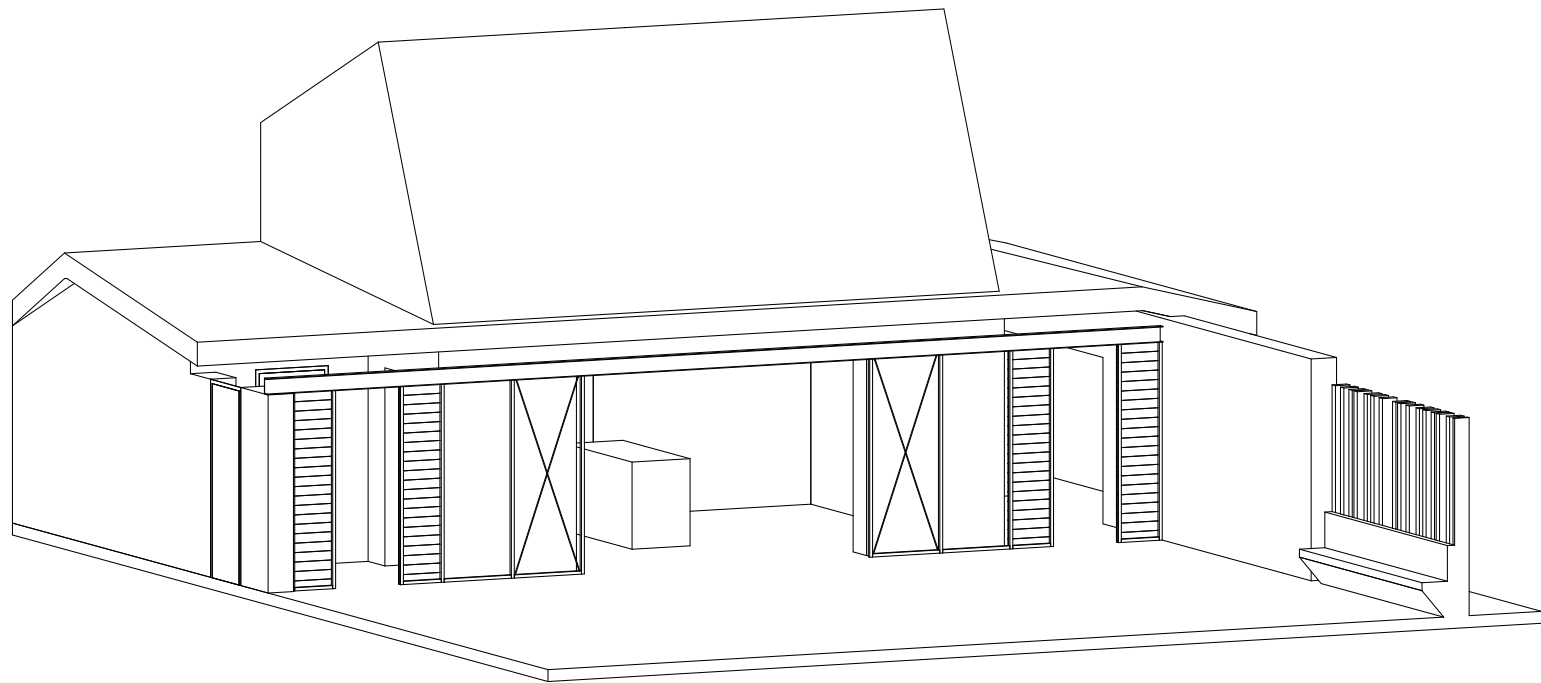

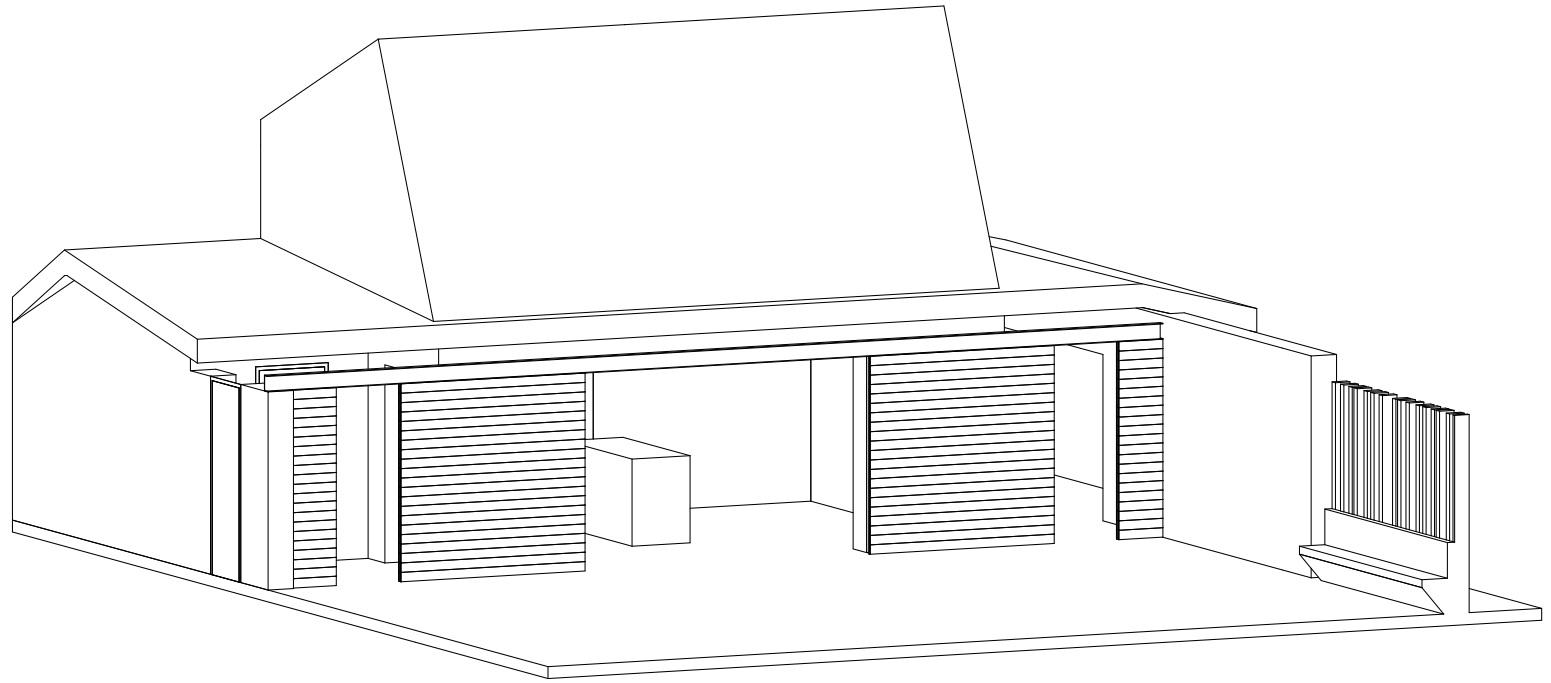

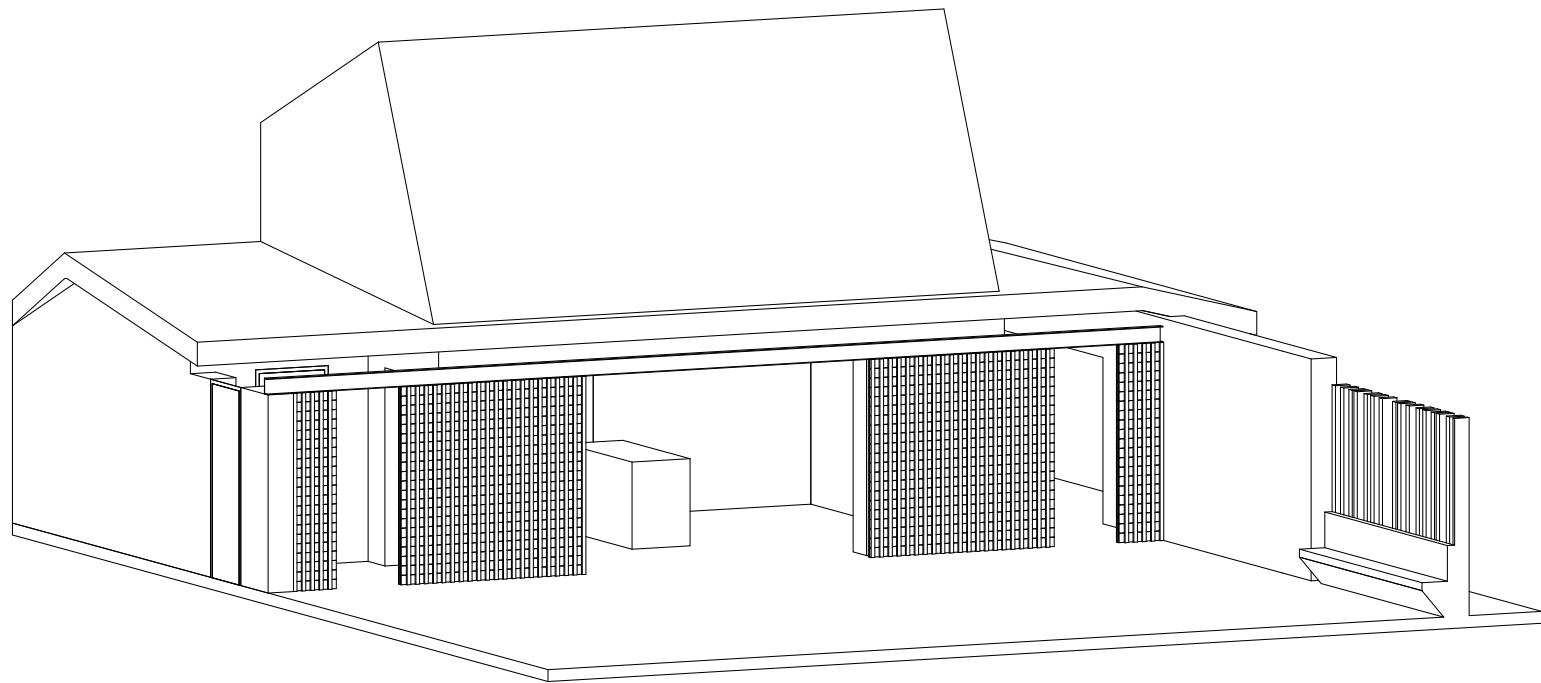

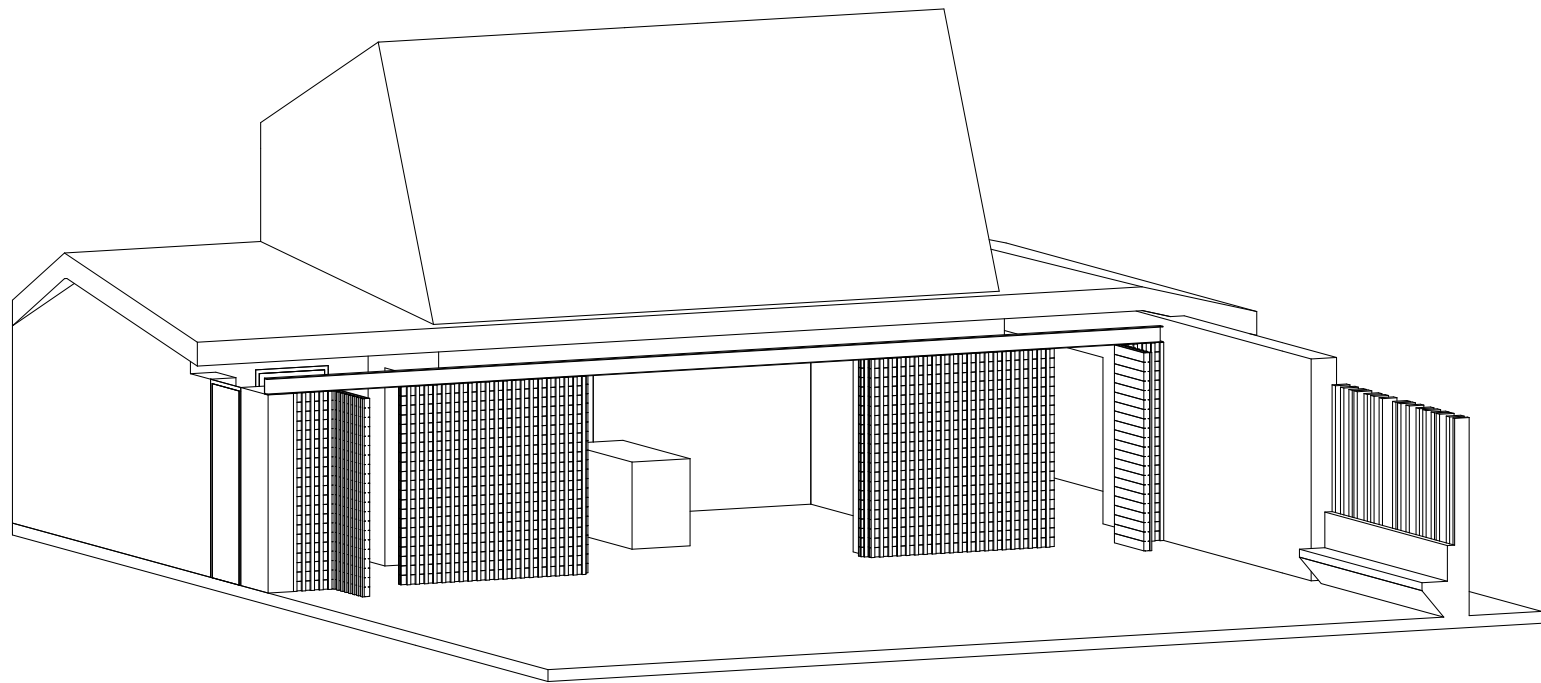

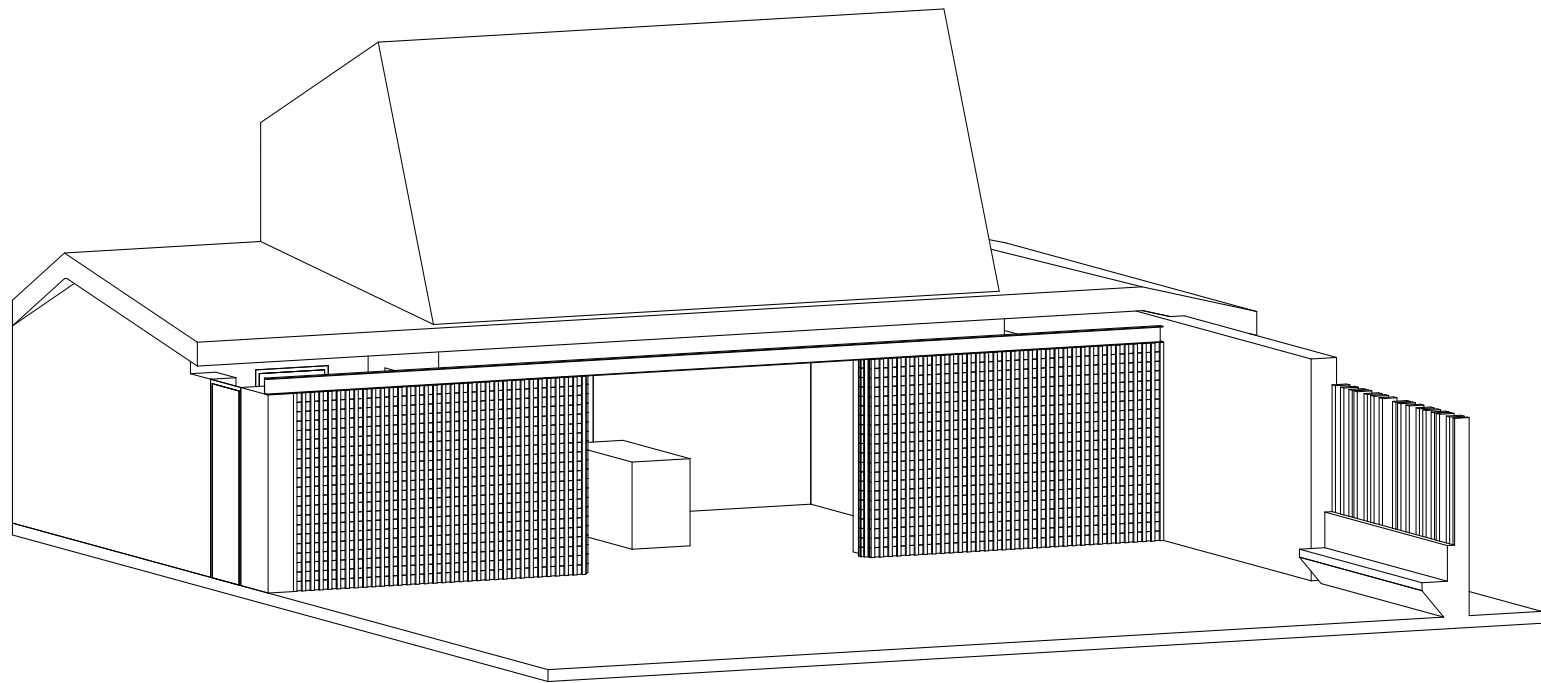

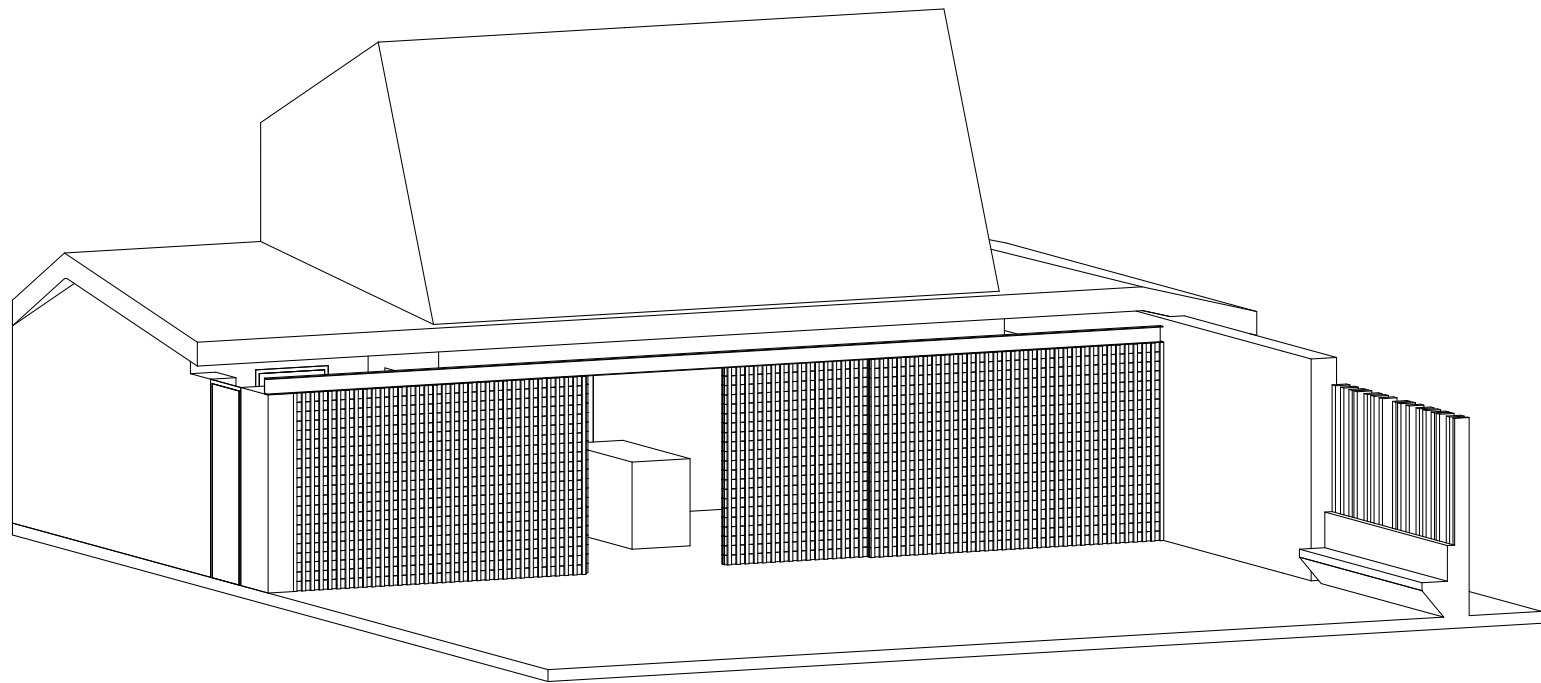

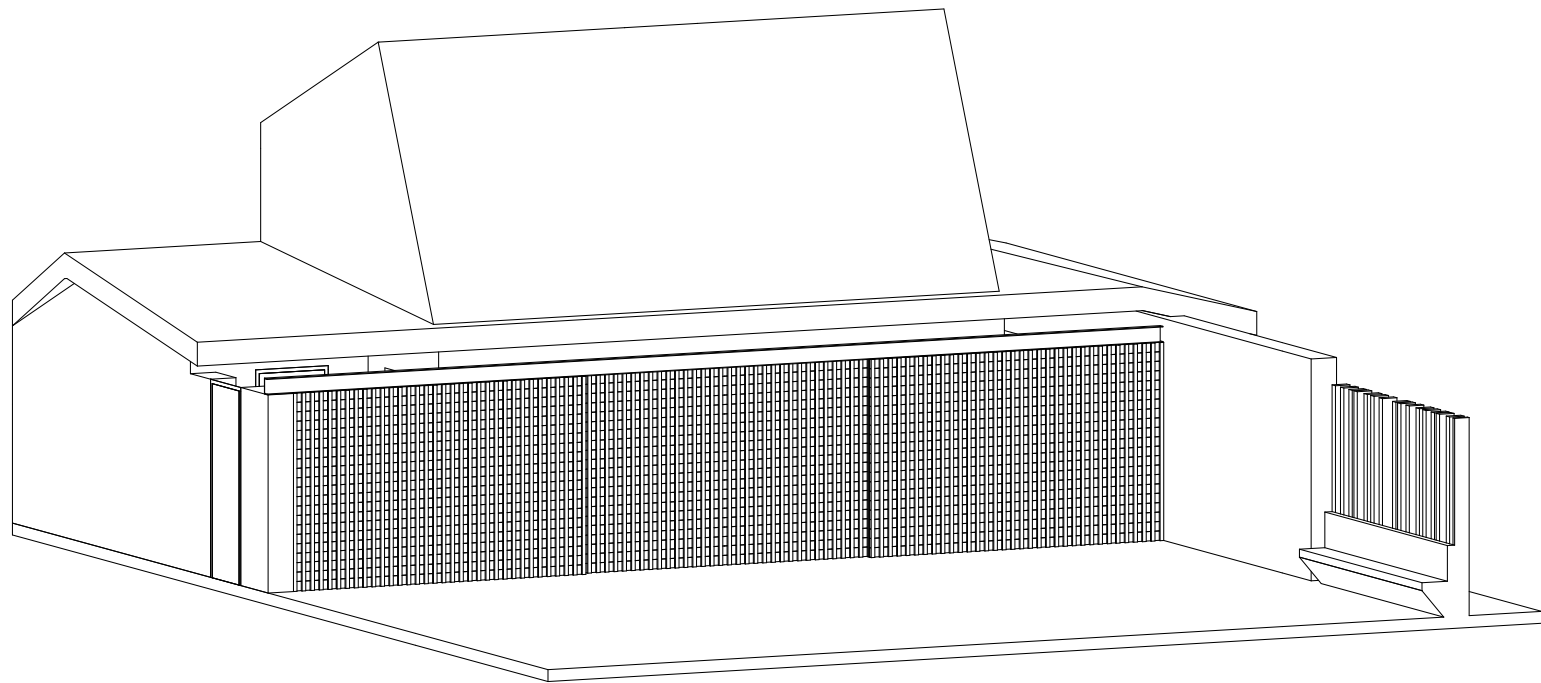

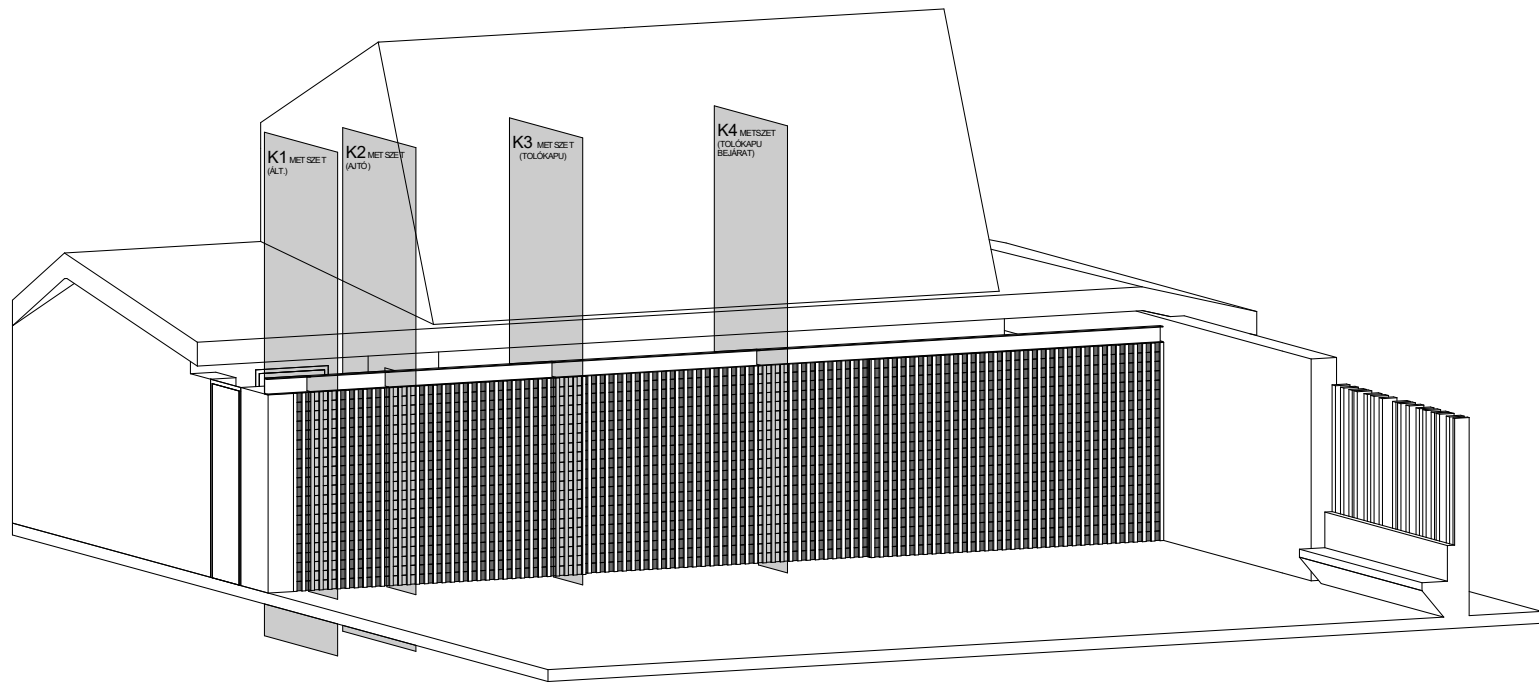

K1 METSZET
(ÁLT.)

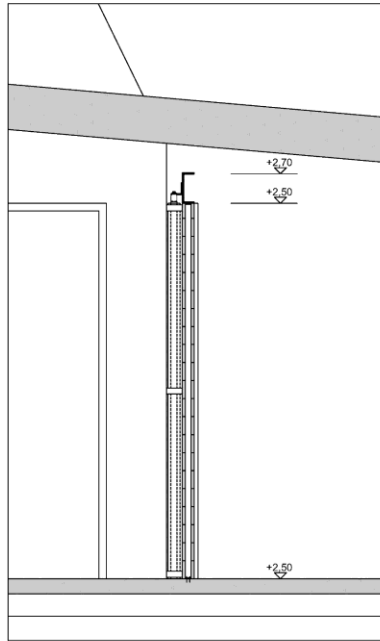

ELŐTÉR
(FEDETT-NYITOTT)

TORNÁC
(FEDETT-NYITOTT)

K2 METSZET
(AJTÓ)

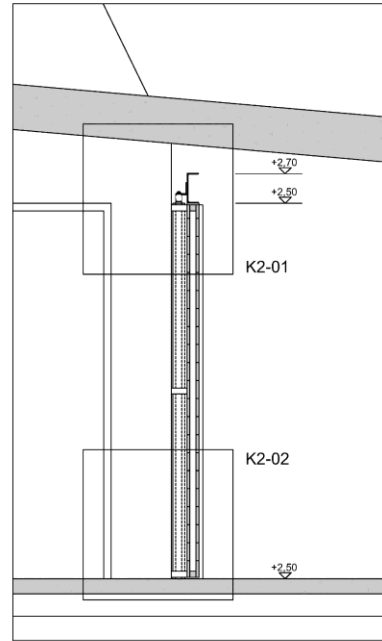

ELŐTÉR
(FEDETT-NYITOTT)

TORNÁC
(FEDETT-NYITOTT)

K3 METSZET
(TOLÓKAPU)

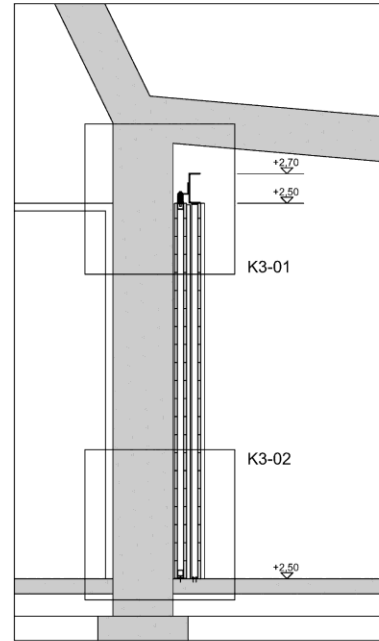

RAVATALOZÓ

TORNÁC
(FEDETT-NYITOTT)

K4 METSZET
(TOLÓKAPU-BEJÁRAT)

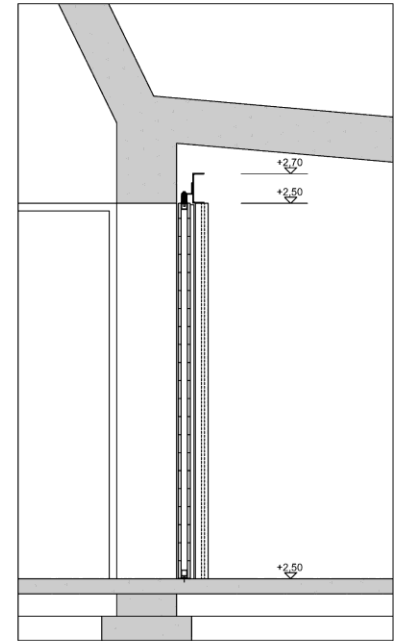

RAVATALOZÓ

TORNÁC
(FEDETT-NYITOTT)

K2-01

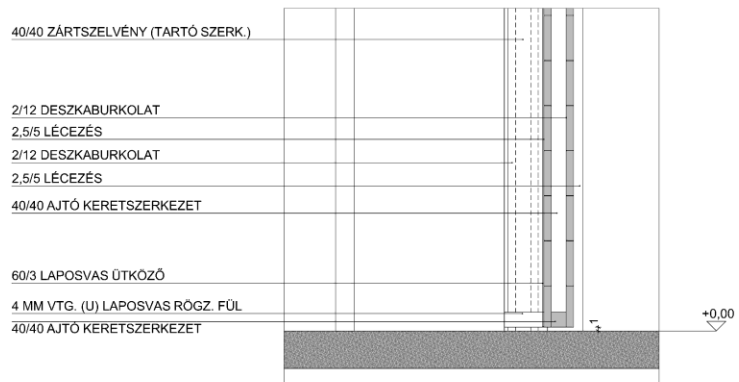
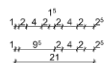
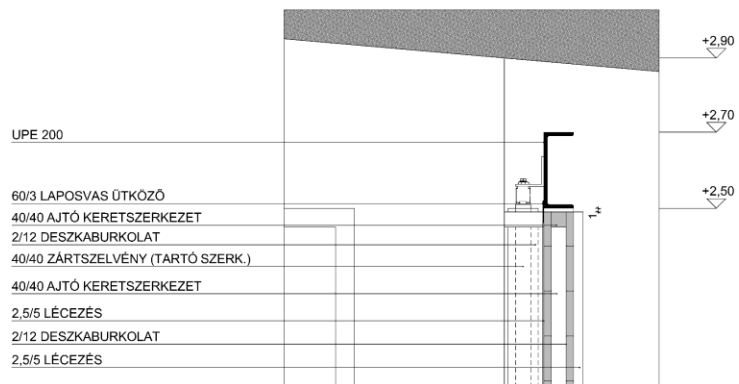

K2-02

K3-01

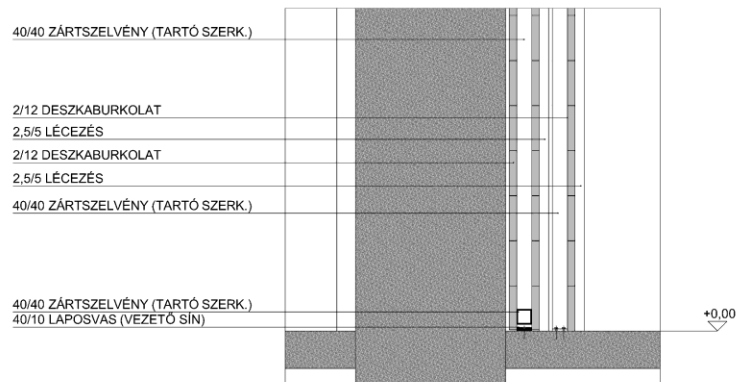
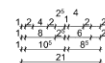
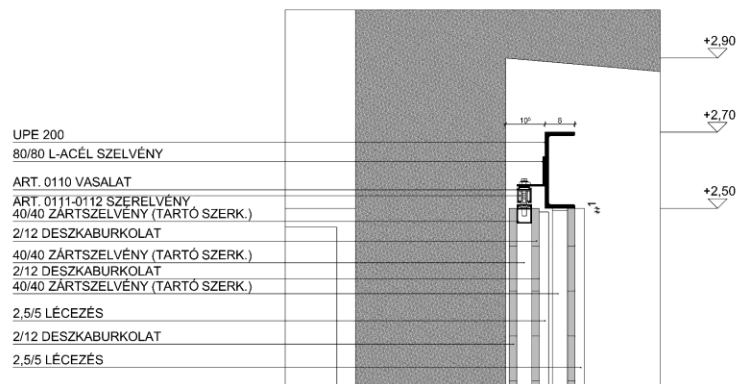

K3-02

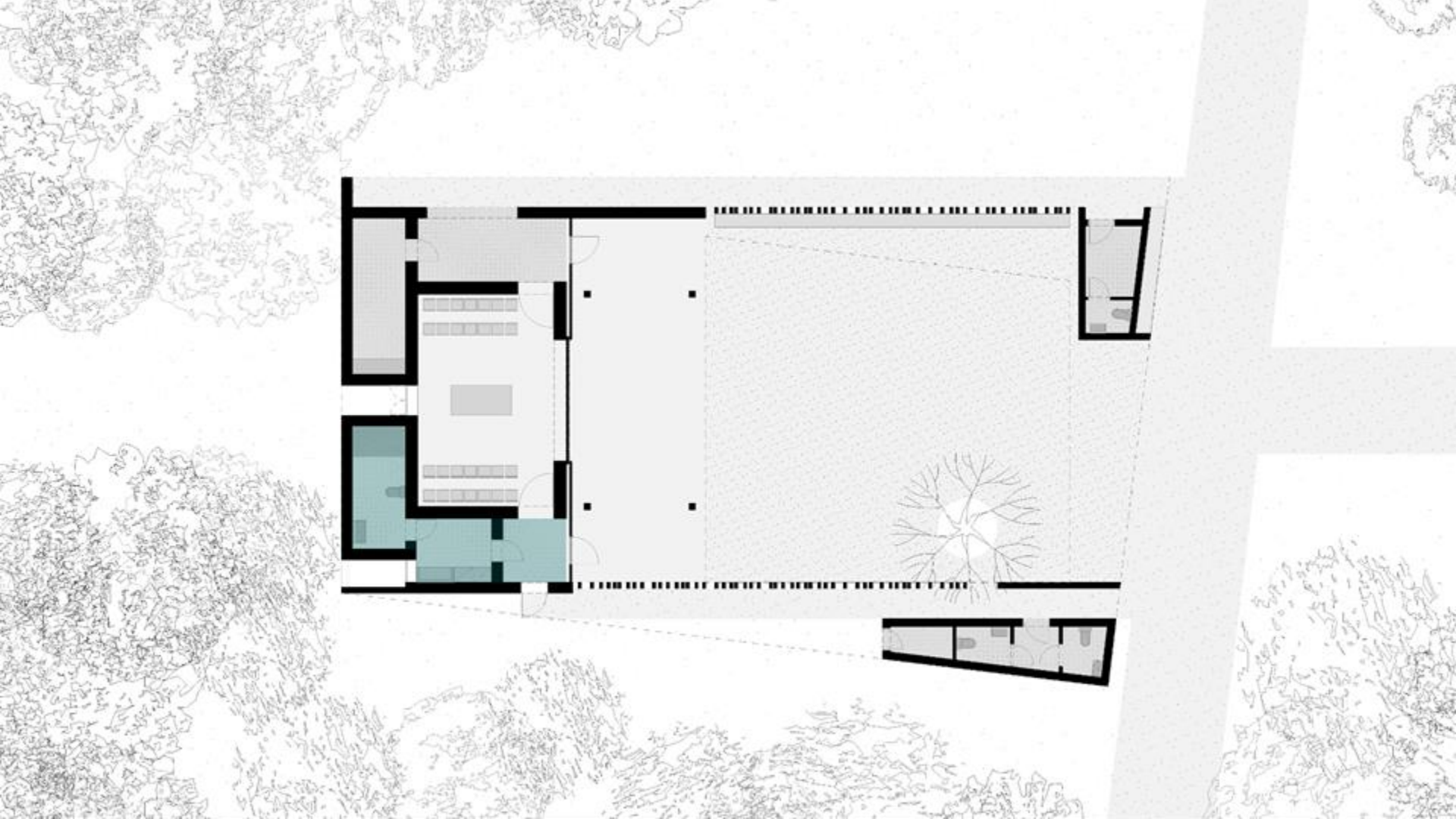

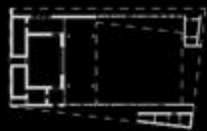
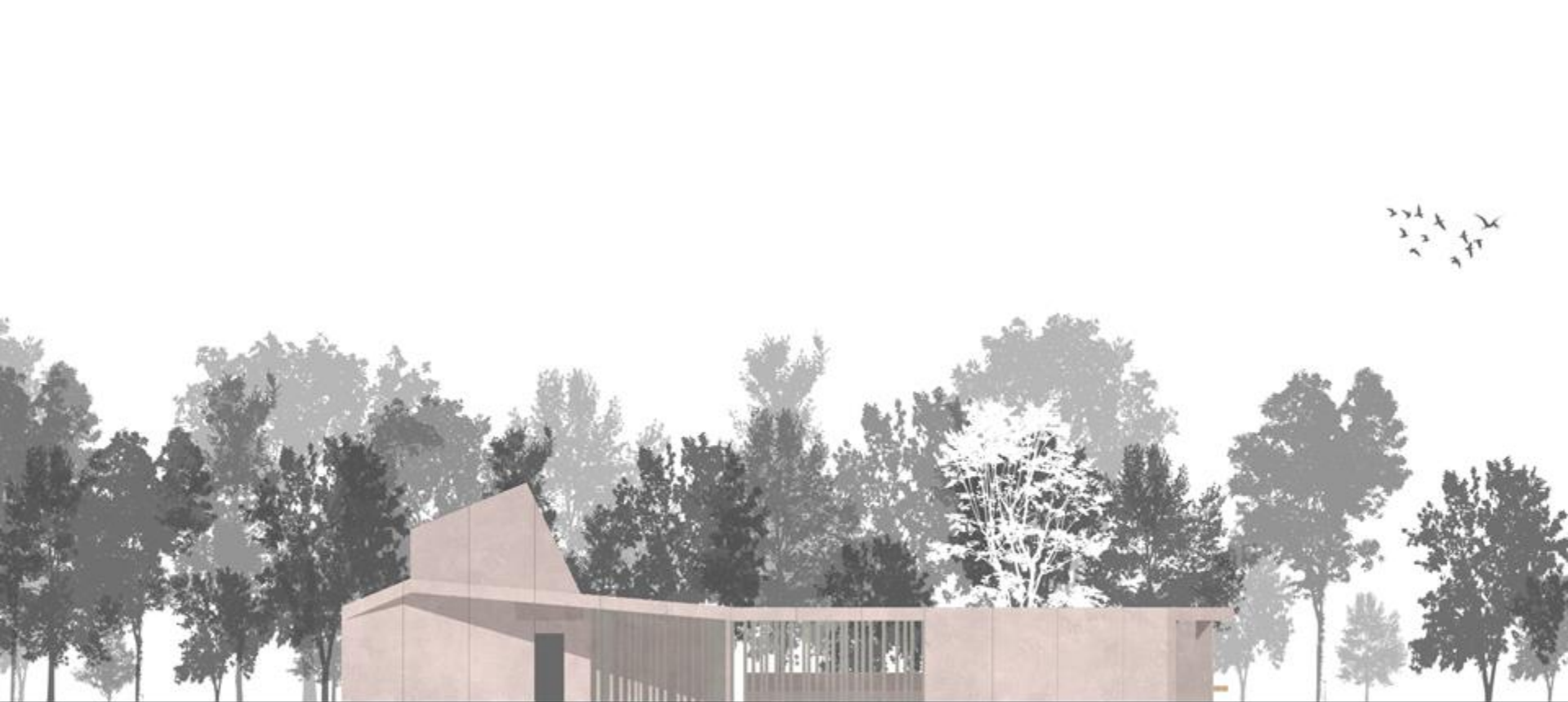

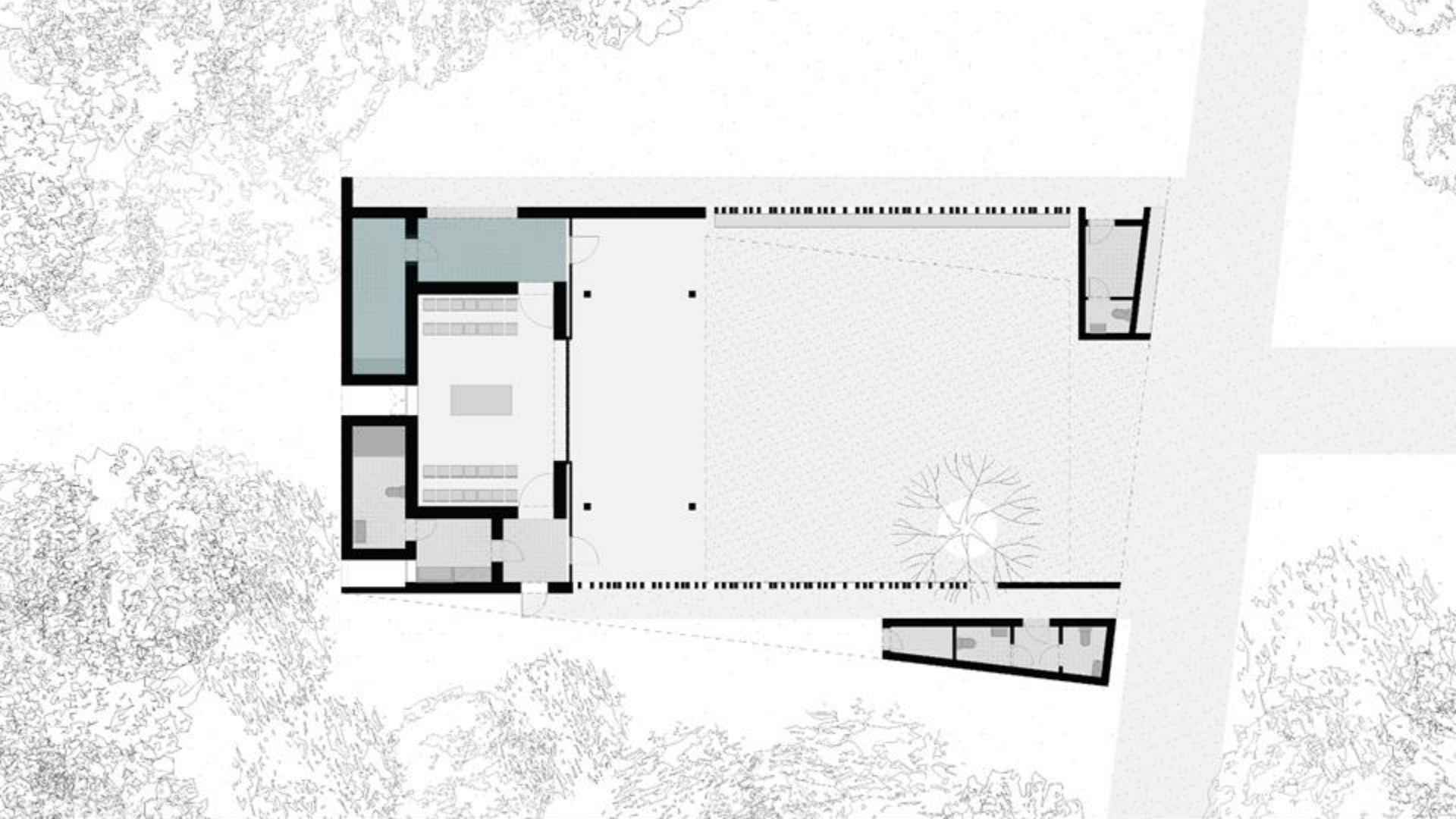

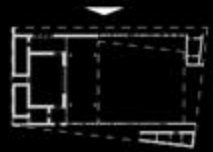
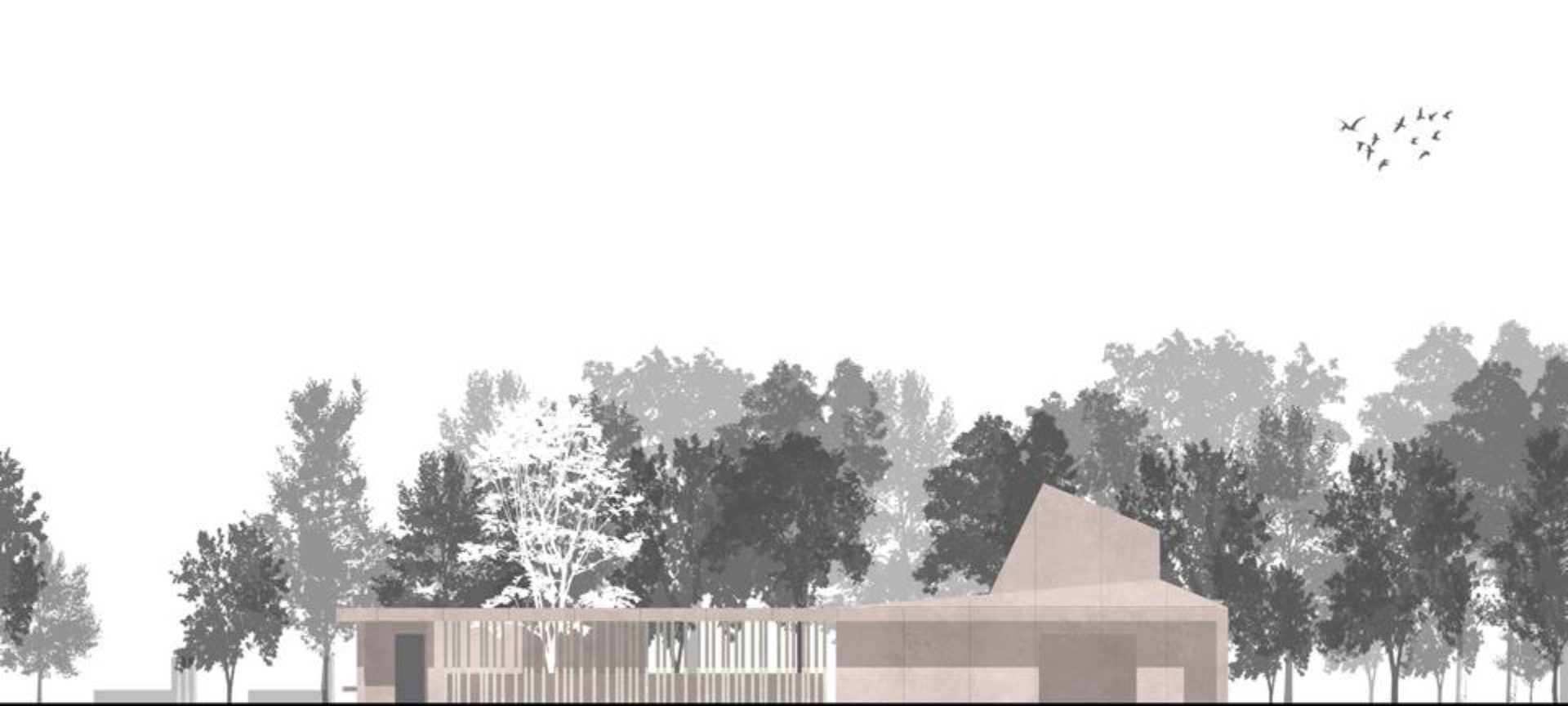

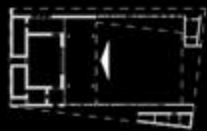
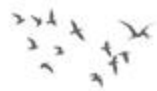

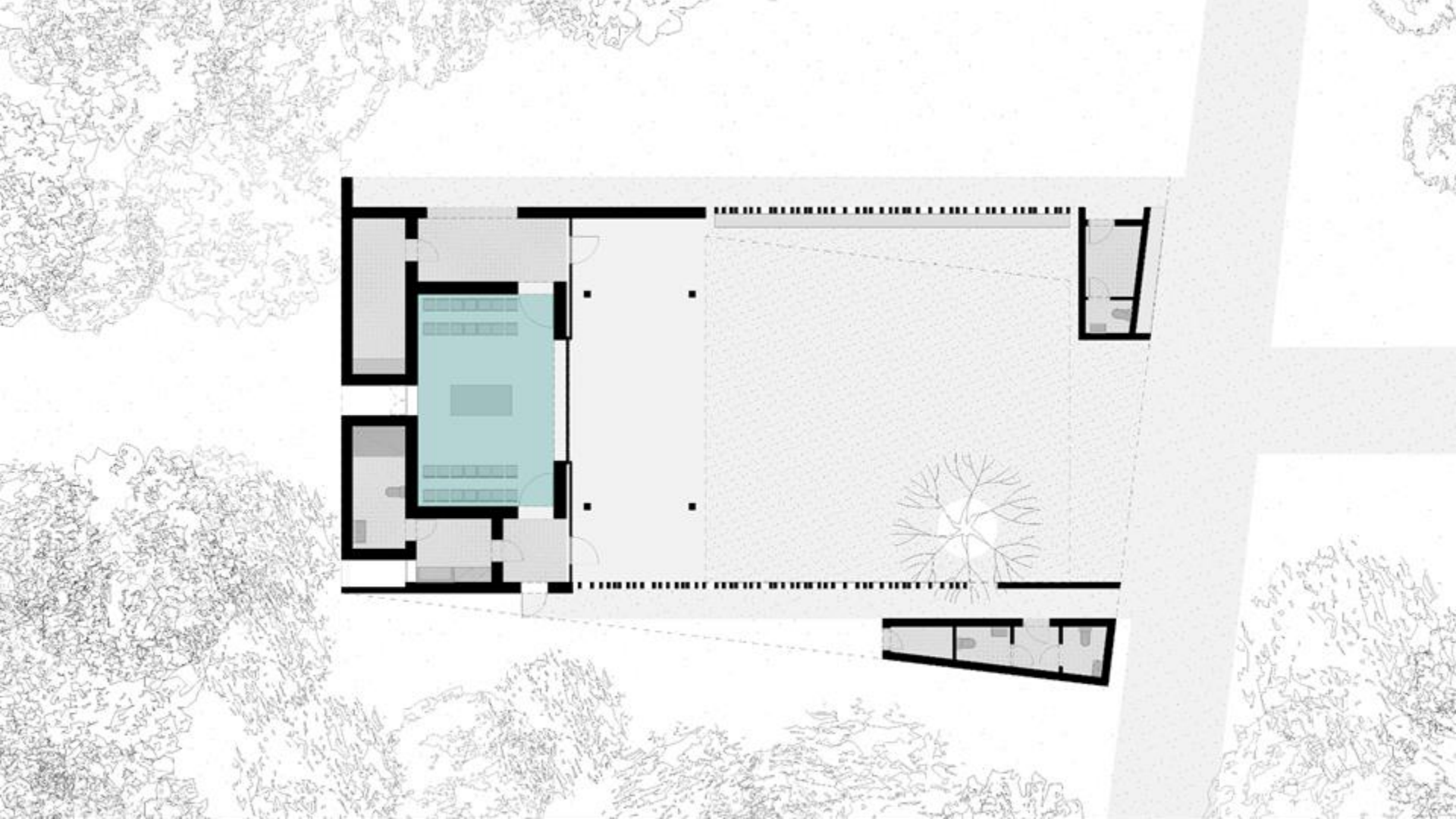

RP1 - Talajon fekvő padló

1 rfg	csiszolt felületű betonpadló
6 cm	esztrich
1 rfg	0,2 mm vastagságú PE fólia elválasztó-csisztató rfg, 15 cm-es áttáplálással lazán fektetve
1 rfg	legalább 4 mm vastagságú poliészterfátyol betétes, SBS modifikált bitumenes vastaglémez talajnedvesség elleni szigetelés
1 rfg	hideg bitumen máz keletítés, általános felületen a felülettől függően
15 cm	vasalt ajzatbeton
15 cm	kavics feltöltés fermét talaj

RP2 - Járda

10 cm	simított beton
15 cm	kavics feltöltés fermét talaj

RF1 - Külső fal

7 cm	előregyártott vasbeton burkolat
5 cm	légrés
40 cm	monolit vasbeton falazat

RF2 - Külső fal

40 cm	monolit vasbeton falazat
-------	--------------------------

RF3 - Külső fal

7 cm	előregyártott vasbeton burkolat
5 cm	légrés
30 cm	monolit vasbeton falazat
5 cm	légrés
7 cm	előregyártott vasbeton burkolat

RF4 - Külső fal

7 cm	előregyártott vasbeton burkolat
5 cm	légrés
30 cm	monolit vasbeton falazat

RT1 - Magastető

7 cm	előregyártott vasbeton burkolat
5 cm	tartószerk
35 cm	monolit vasbeton födém
2 cm	dombornyomott HDPE műanyag felületszivargó, -125 g/m ² felülettömegű műanyag fátyol szűrőréteg gyán kasírozással
1 rfg.	300 g/m ² felülettömegű műanyag filc mechanikai védőréteg
0,4 cm	csapadékvíz hatására méretezett bitumenmentes, elasztomer hibrid bevonatszigetelés szórt kivételben (pl.: MC EXPERT PROOF), két rétegben elkészítve, legalább 5,5 kg/m ² anyagfelhasználással, 4,8 mm nedves, 4 mm száraz rétegvastagsággal
1 rfg.	rendszeresgát alapozás: az alkalmazott bitumenmentes, elasztomer hibrid bevonatszigetelés

