

Irodaépület

Debrecen

Gambrinus köz

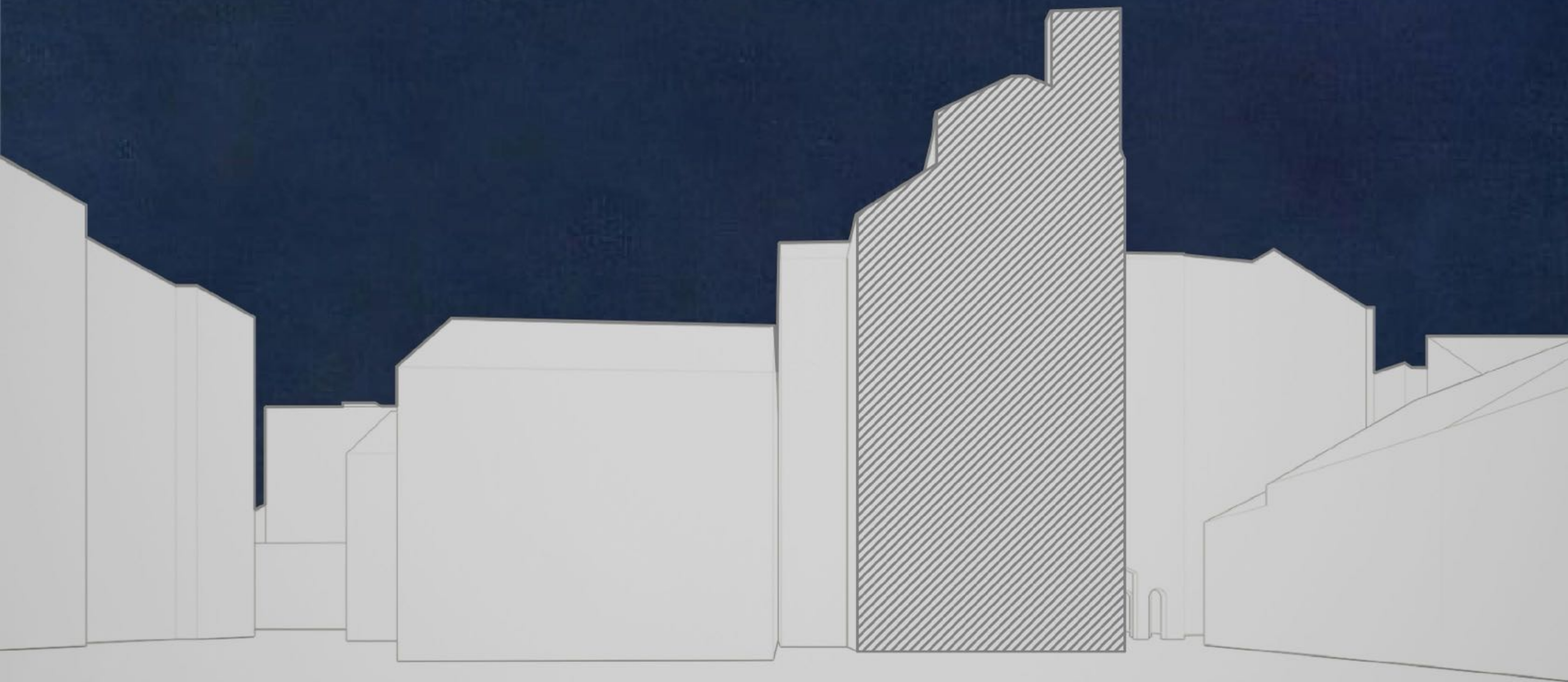

Sike Boglárka



Tiszta és rendezett irodateretek

Saját, fix munkaállomások



Csendes, hatékony terek



Zárt tárgyalók

Étkezési lehetőség

Választató és átalakítható
munkaállomások

Közösségépítő terek

Saját, fix munkaállomások

Tiszta és rendezett irodateretek

Csapatépítő környezet

Hibrid munkavégzés támogatása



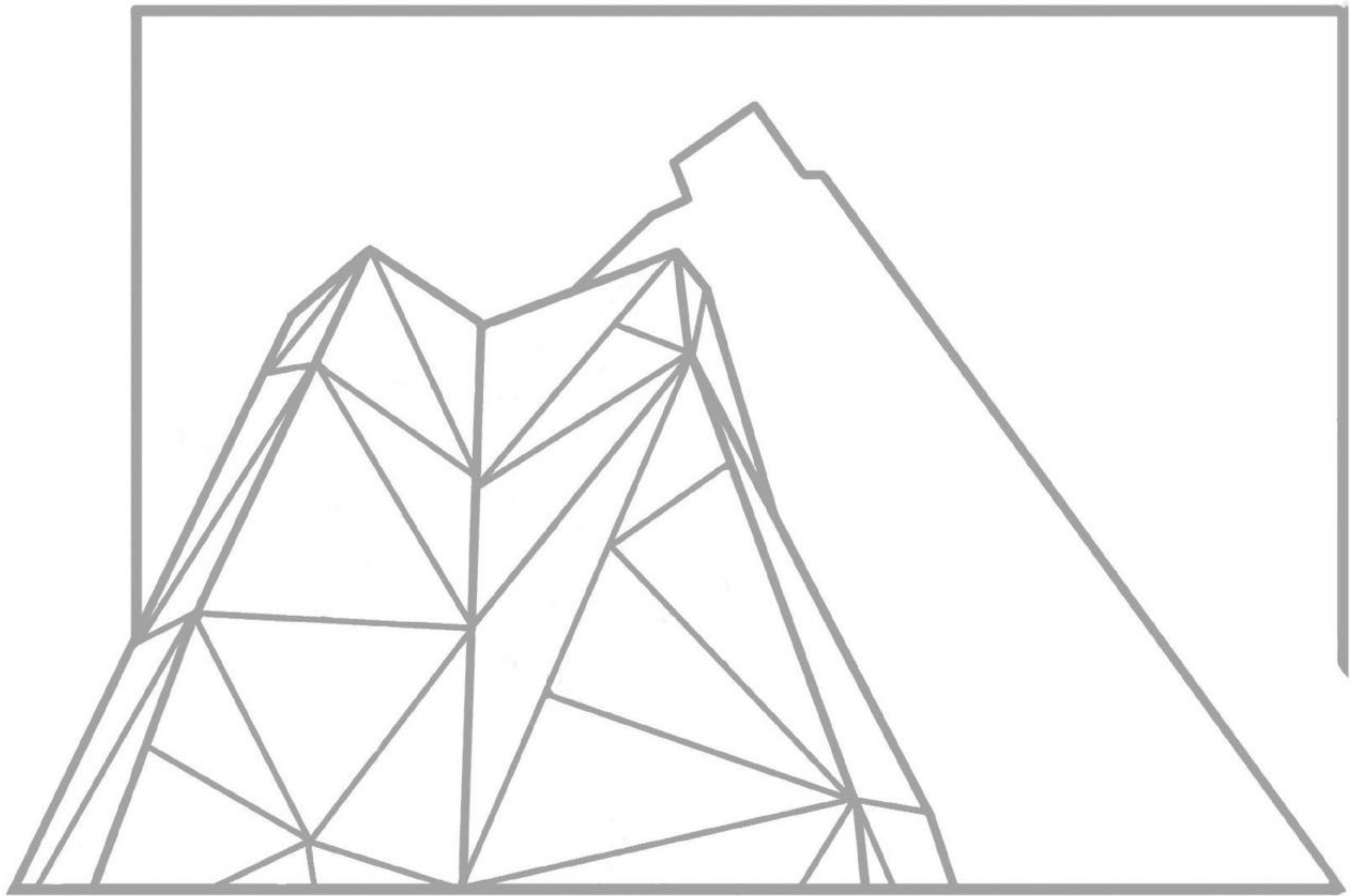



Gambrinus köz
Debrecen

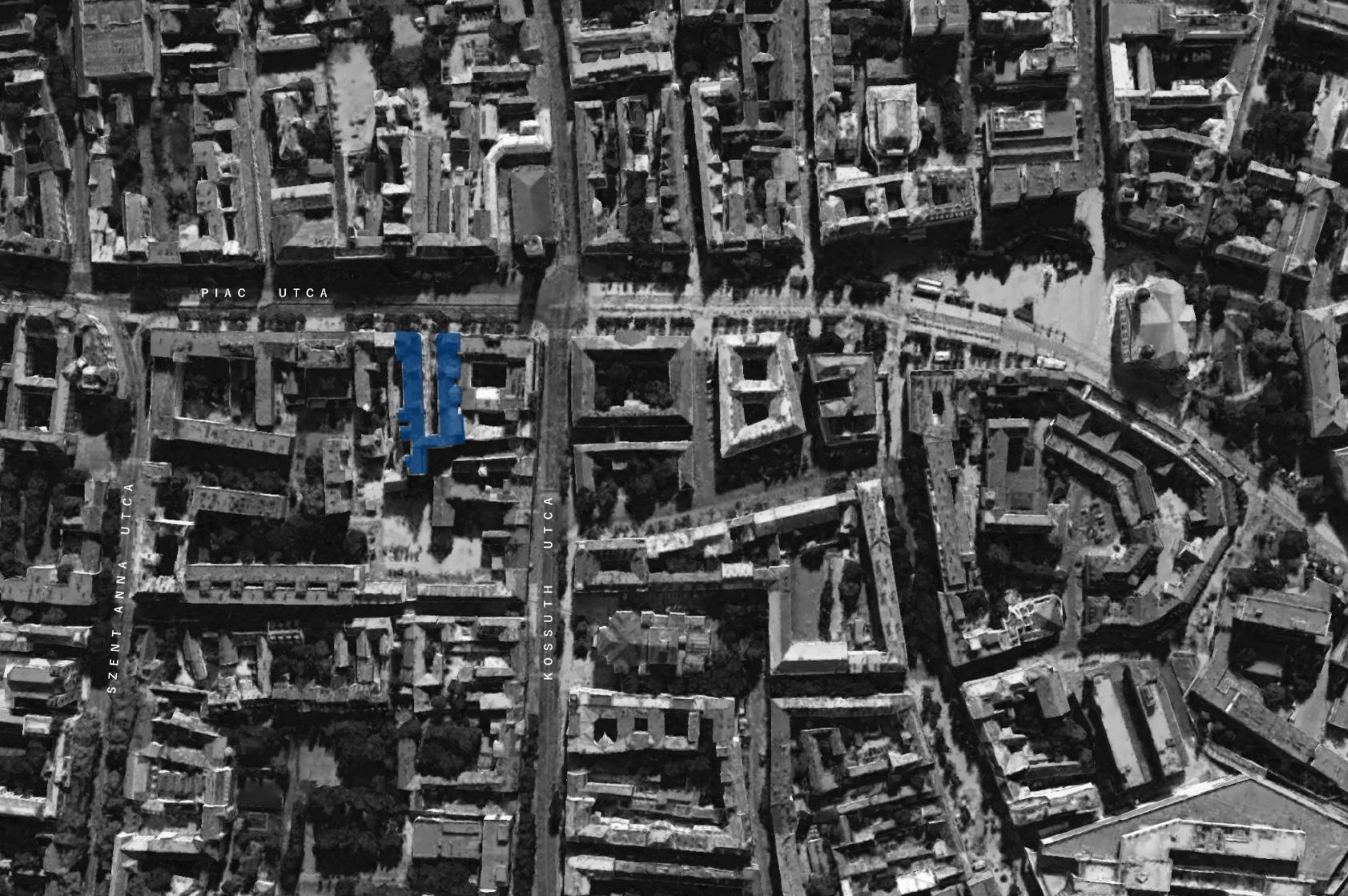

PIAC UTCA

SZENT ANNA UTCA

KOSSUTH UTCA

GAMBRINUS KÖZ

PIAC UTCA



28/C

26/A

28/B

26/B

28/A

GAMBRINUS KÖZ

Debreczen

Új városi bérház átjáró

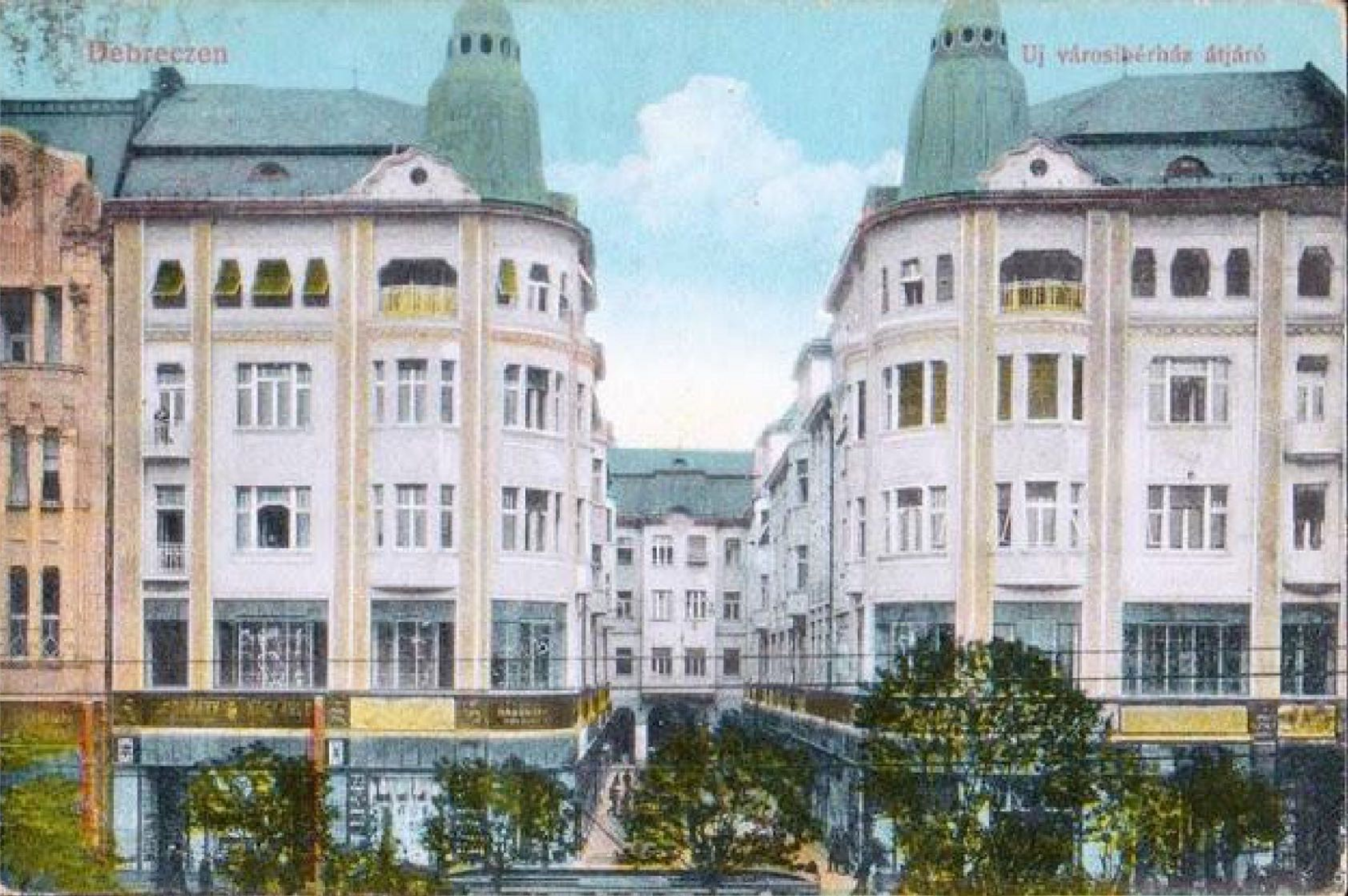











S Z E N T
A N N A
U T C A

K O S S U T H
U T C A

B A T T H Y Á N Y
U T C A

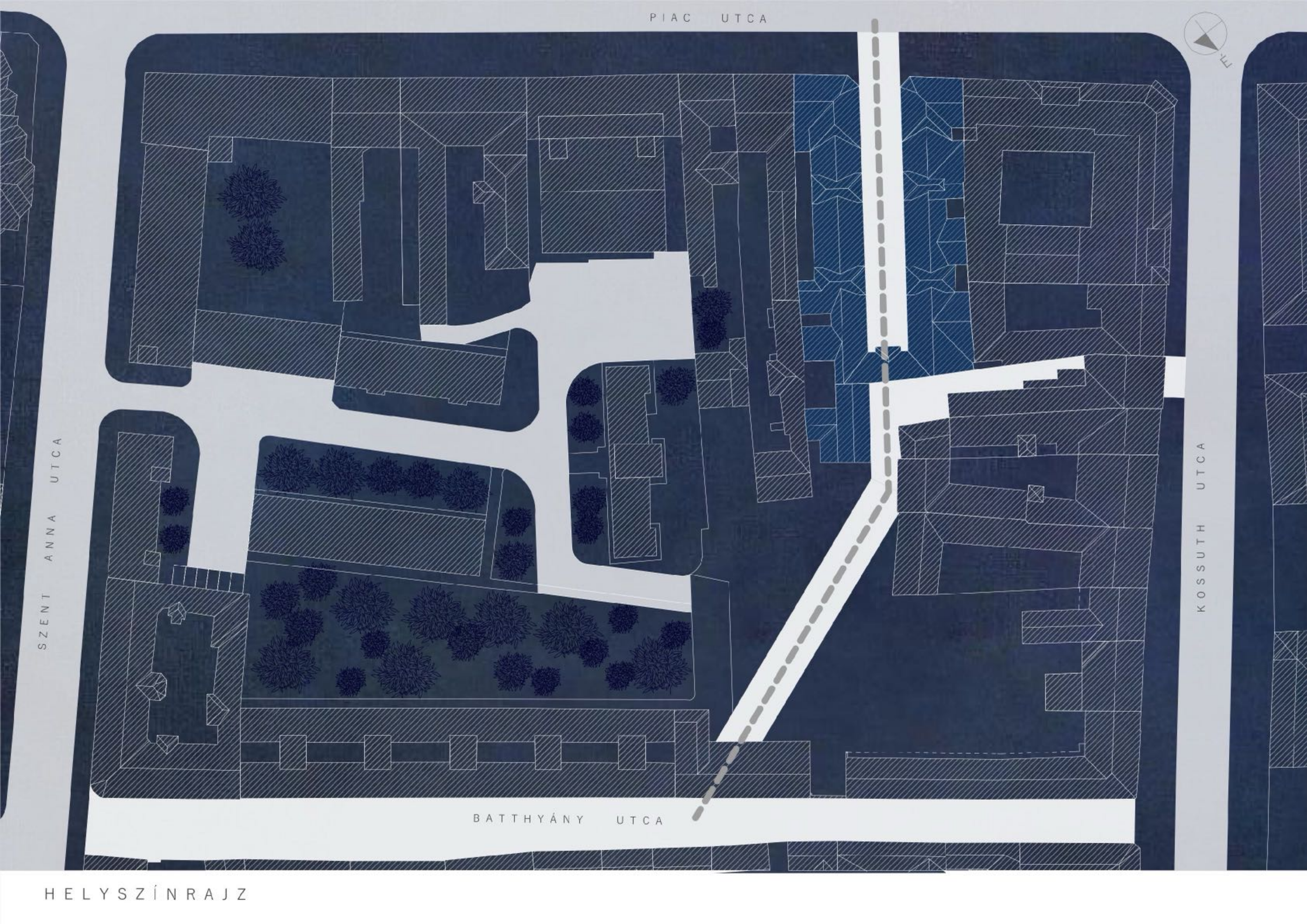



S Z E N T
A N N A
U T C A

K O S S U T H
U T C A

B A T T H Y Á N Y
U T C A





BATTHÁNY UTCA FELŐL

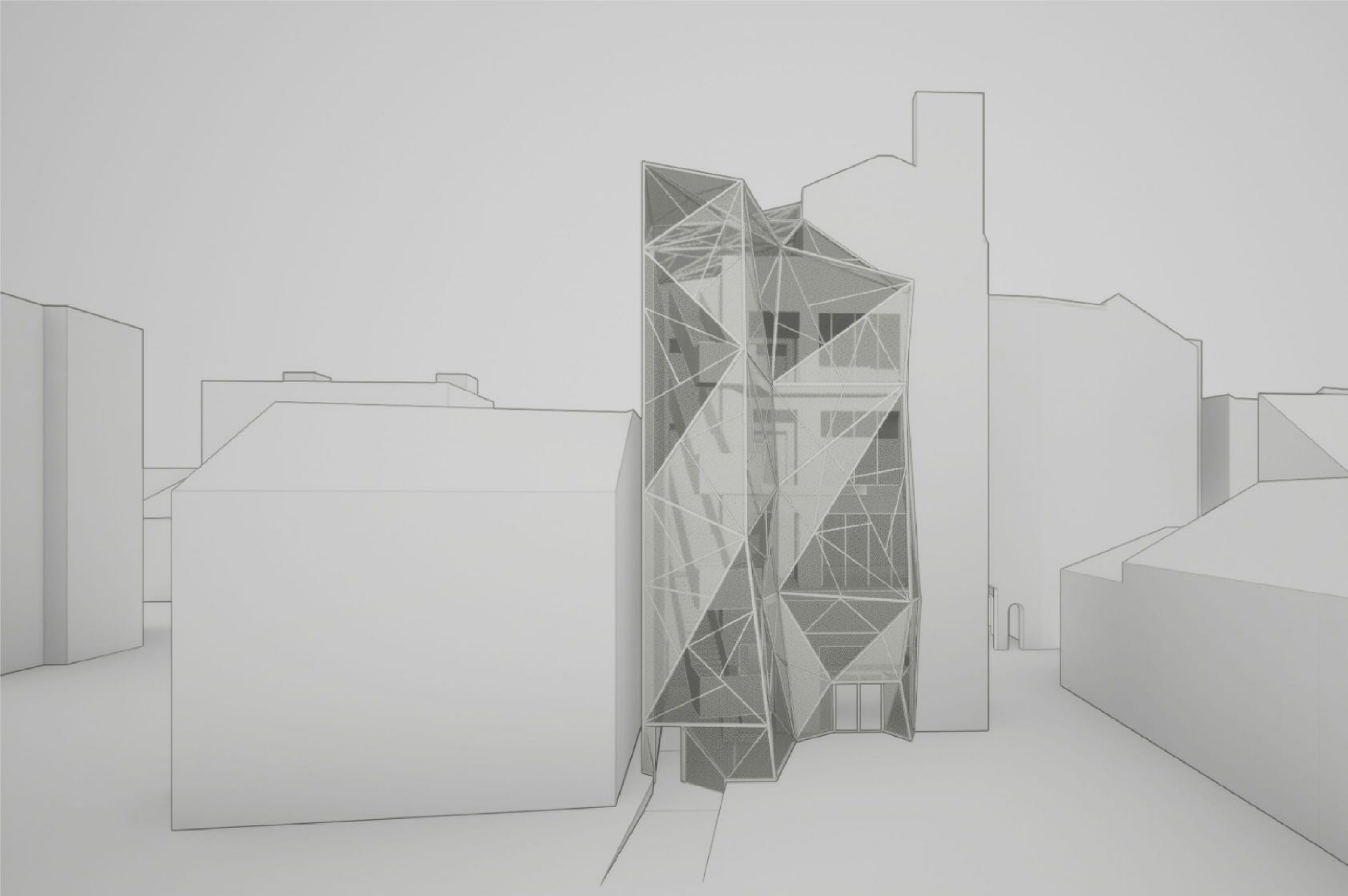

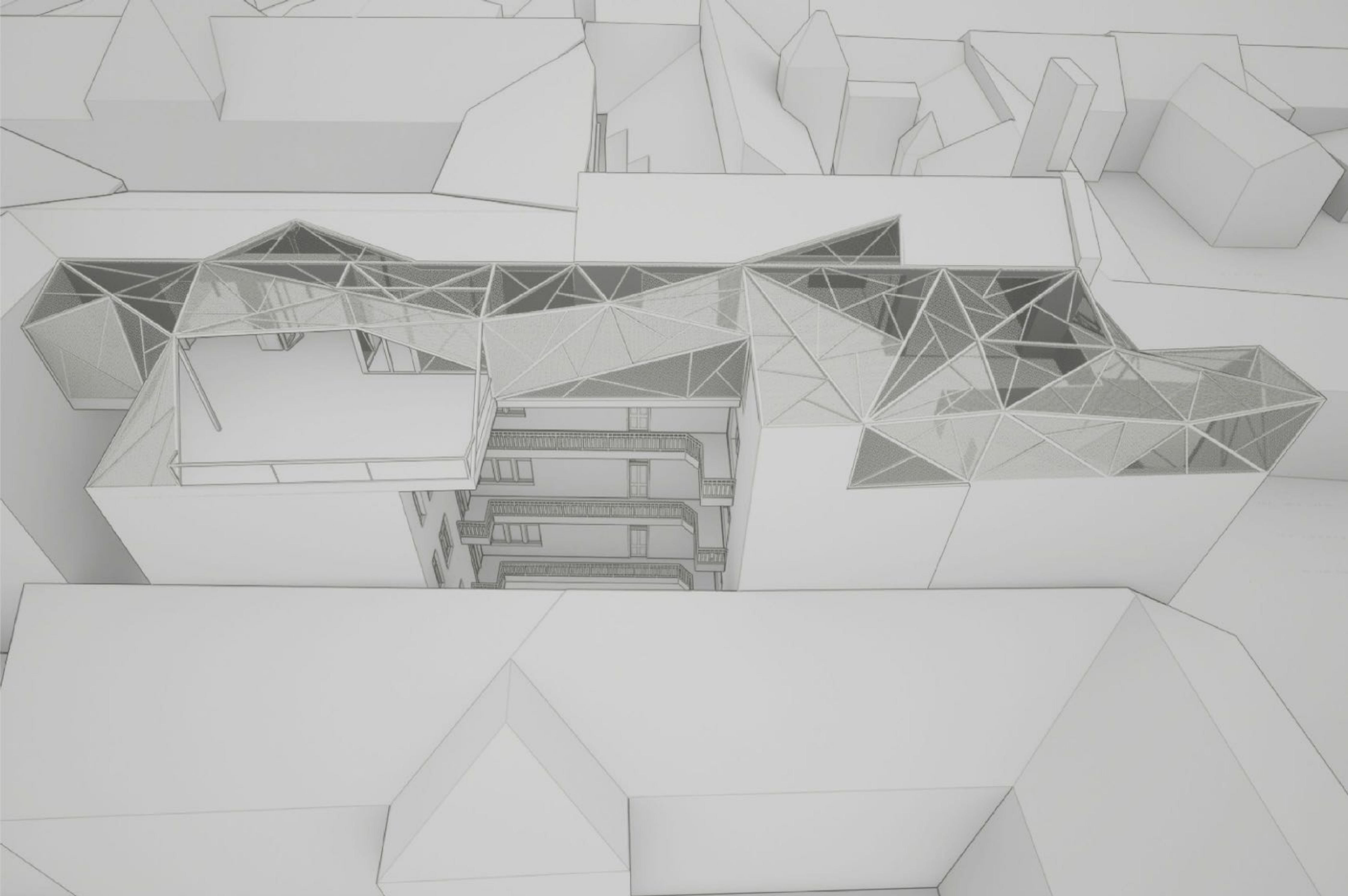



28/A

28/B

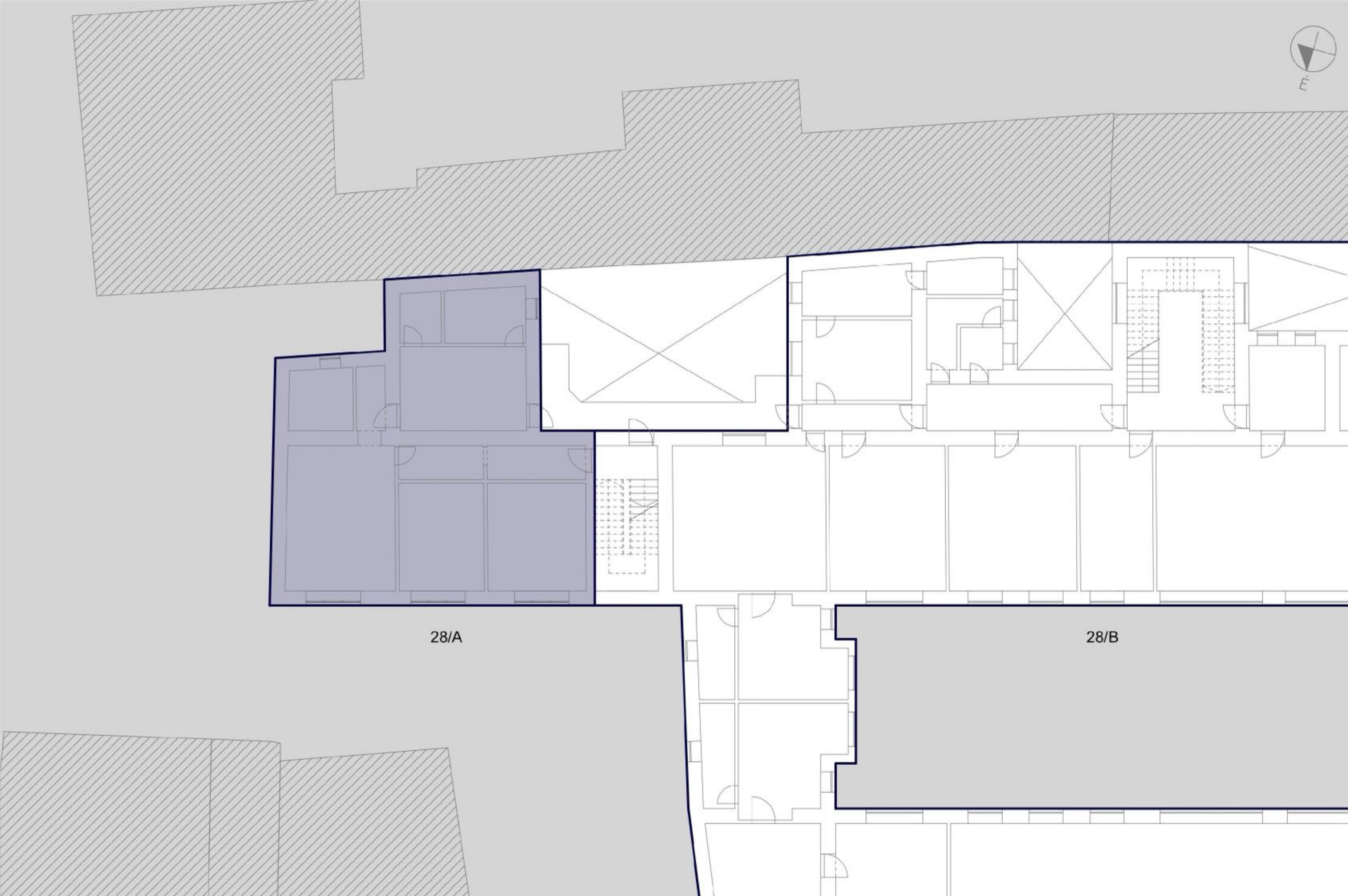

28/A

28/B

Meglévő épület I. emeleti alaprajza

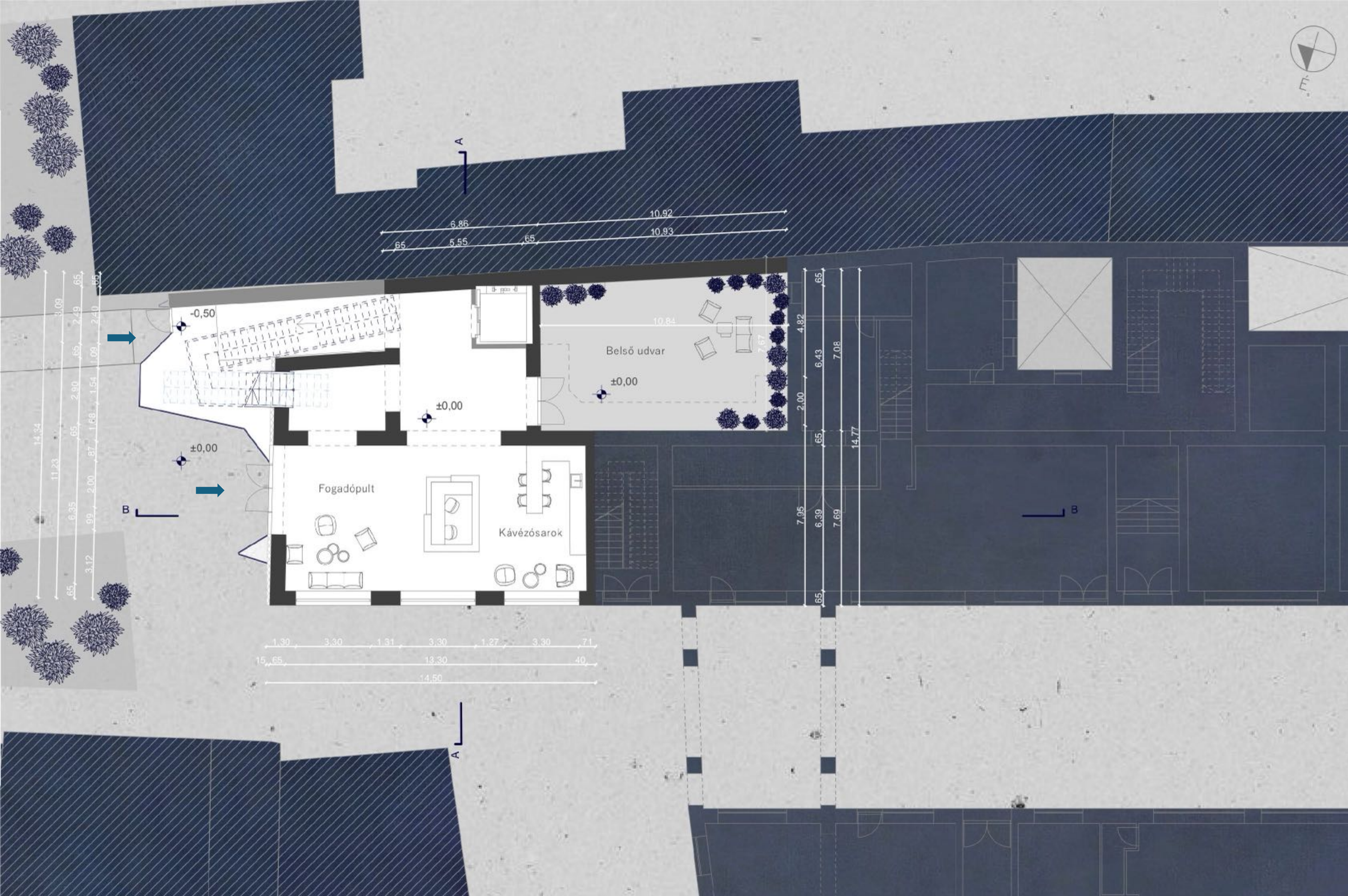

Földszinti alaprajz



Fogadóter

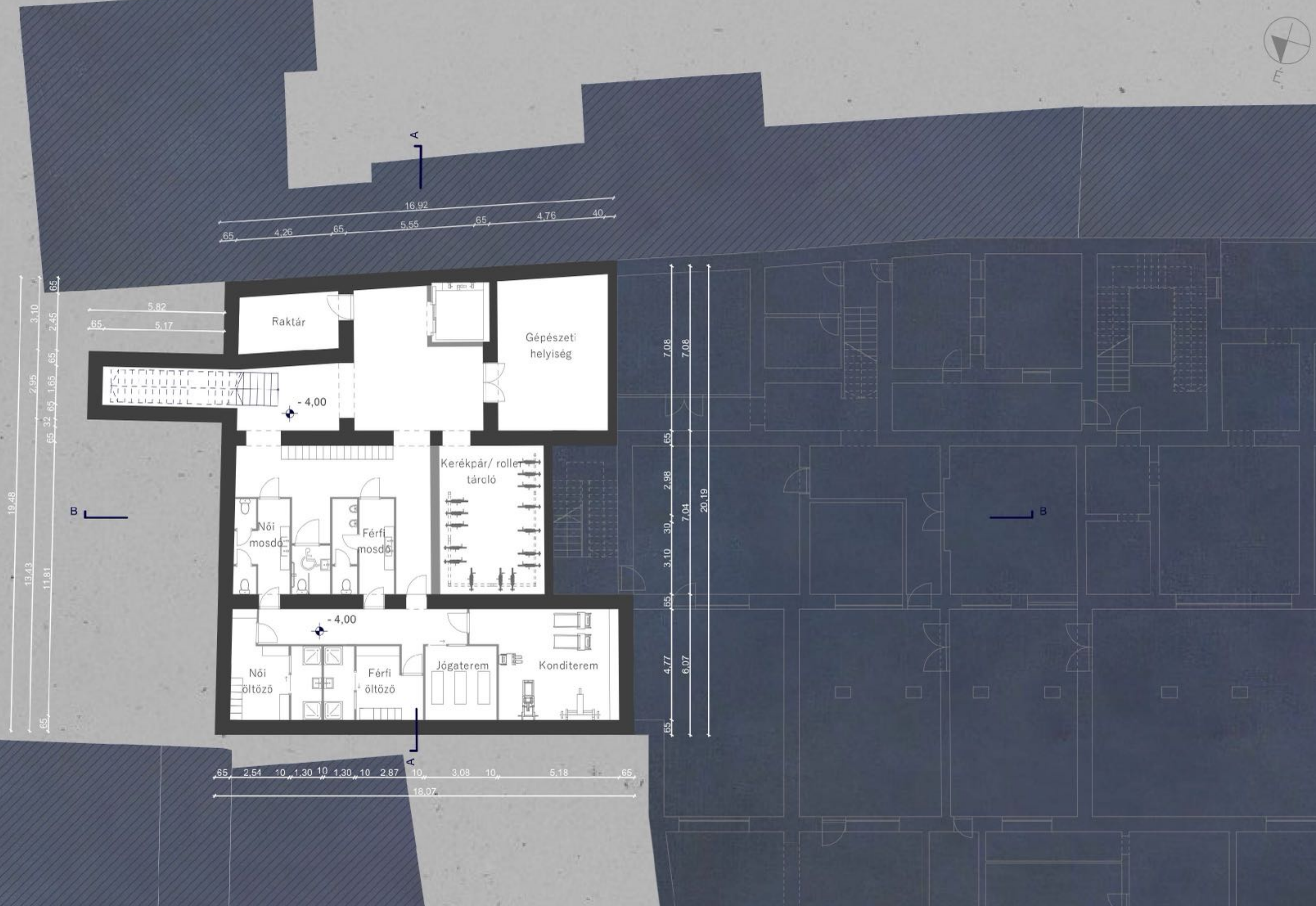

Alagsori alaprajz



Kerékpártároló



Edzőterem



I. emeleti alaprajz



Egyéni munkavégzés szintje

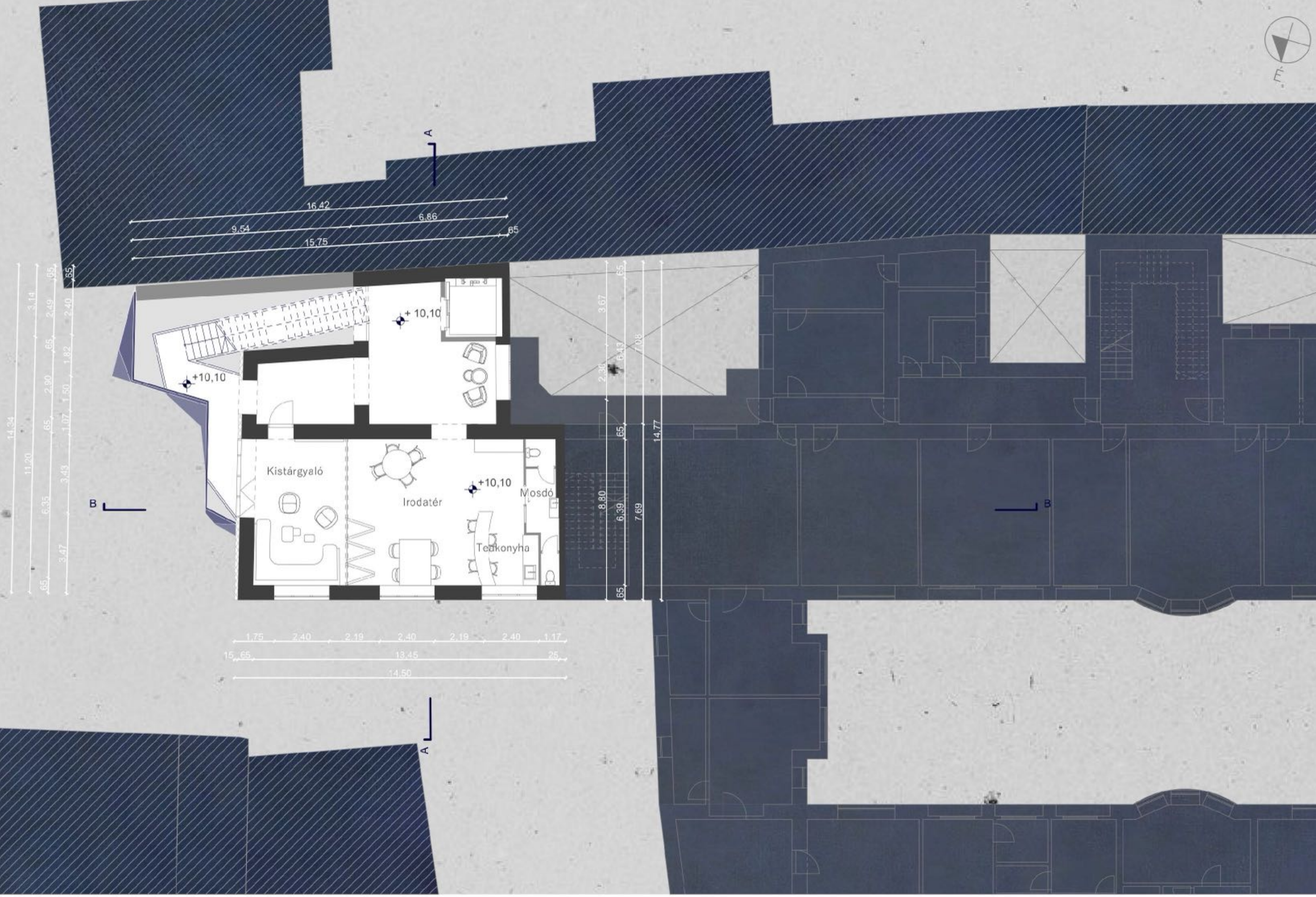

II. emeleti alaprajz



Kistárgyaló és csapatmunka szintje

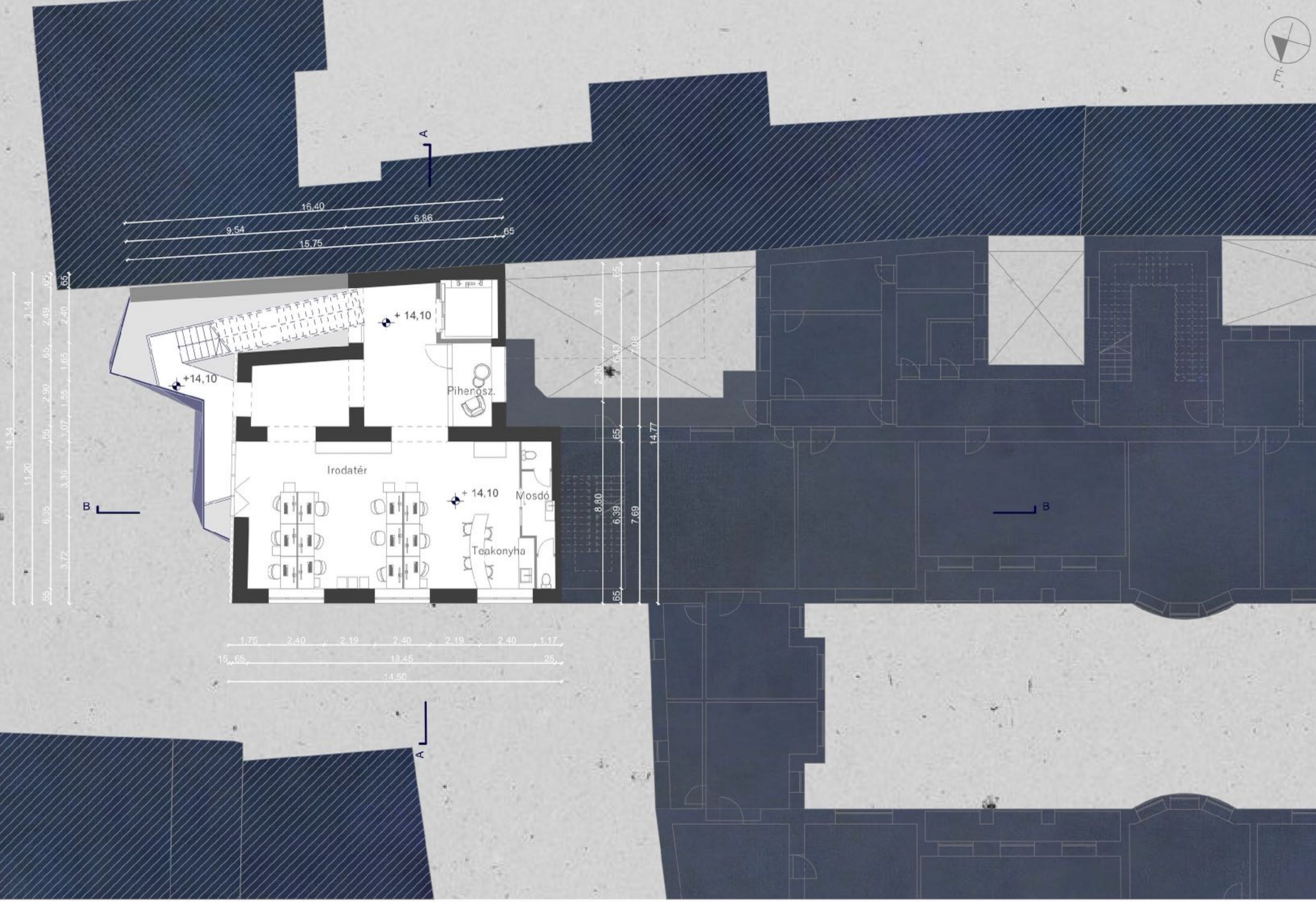

III. emeleti alaprajz



C s a p a t m u n k a s z i n t j e



Tetőtéri alaprajz



Vezetőségi iroda és nagytárgyaló



Közösségi tér



Közösségi tér





Tetőterasz



A - A Metszet

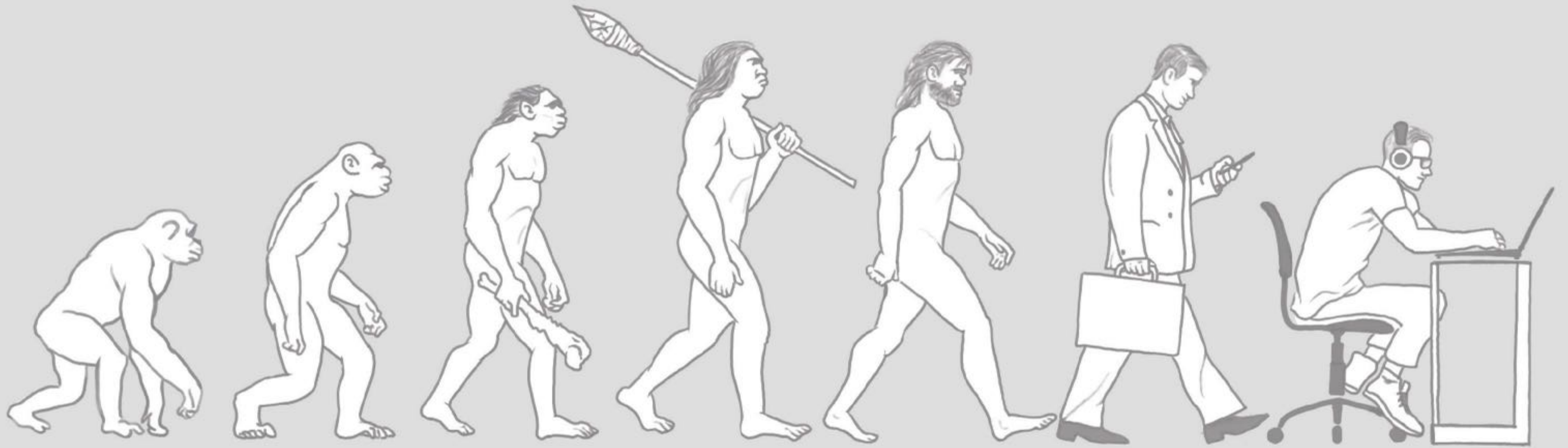

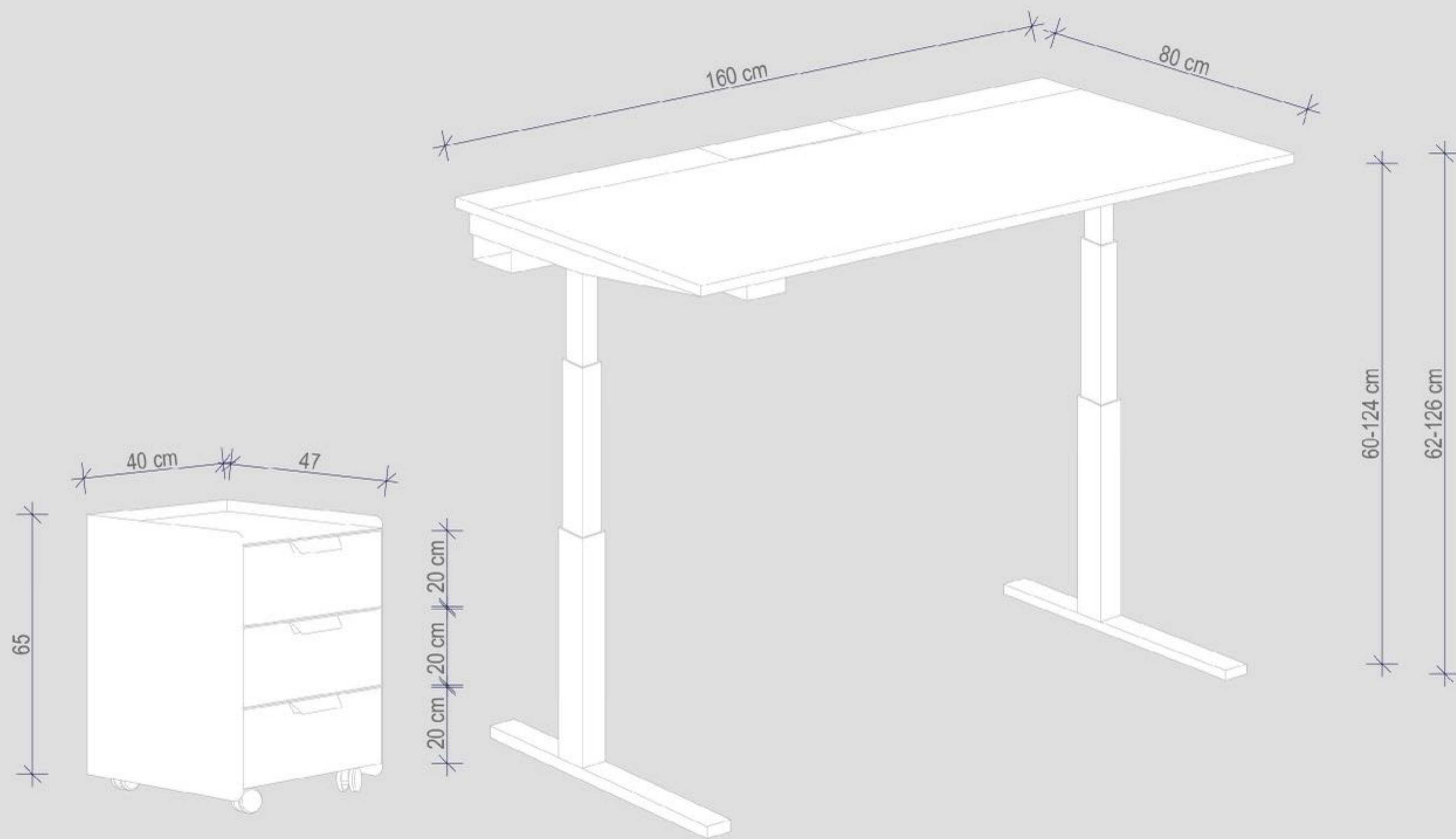



Rugalmas munkaállomások



Meeting room

Tárgyalószoba





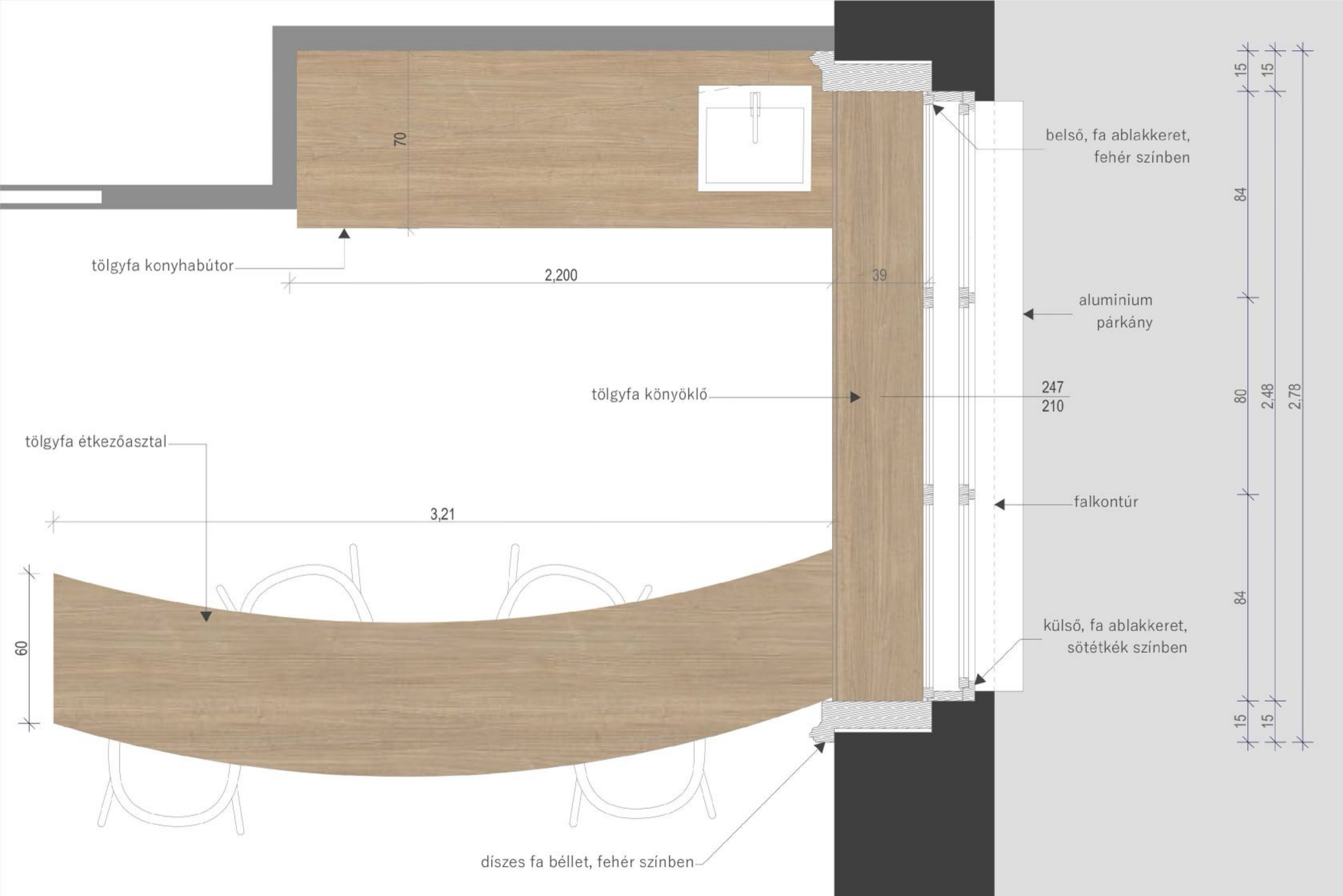

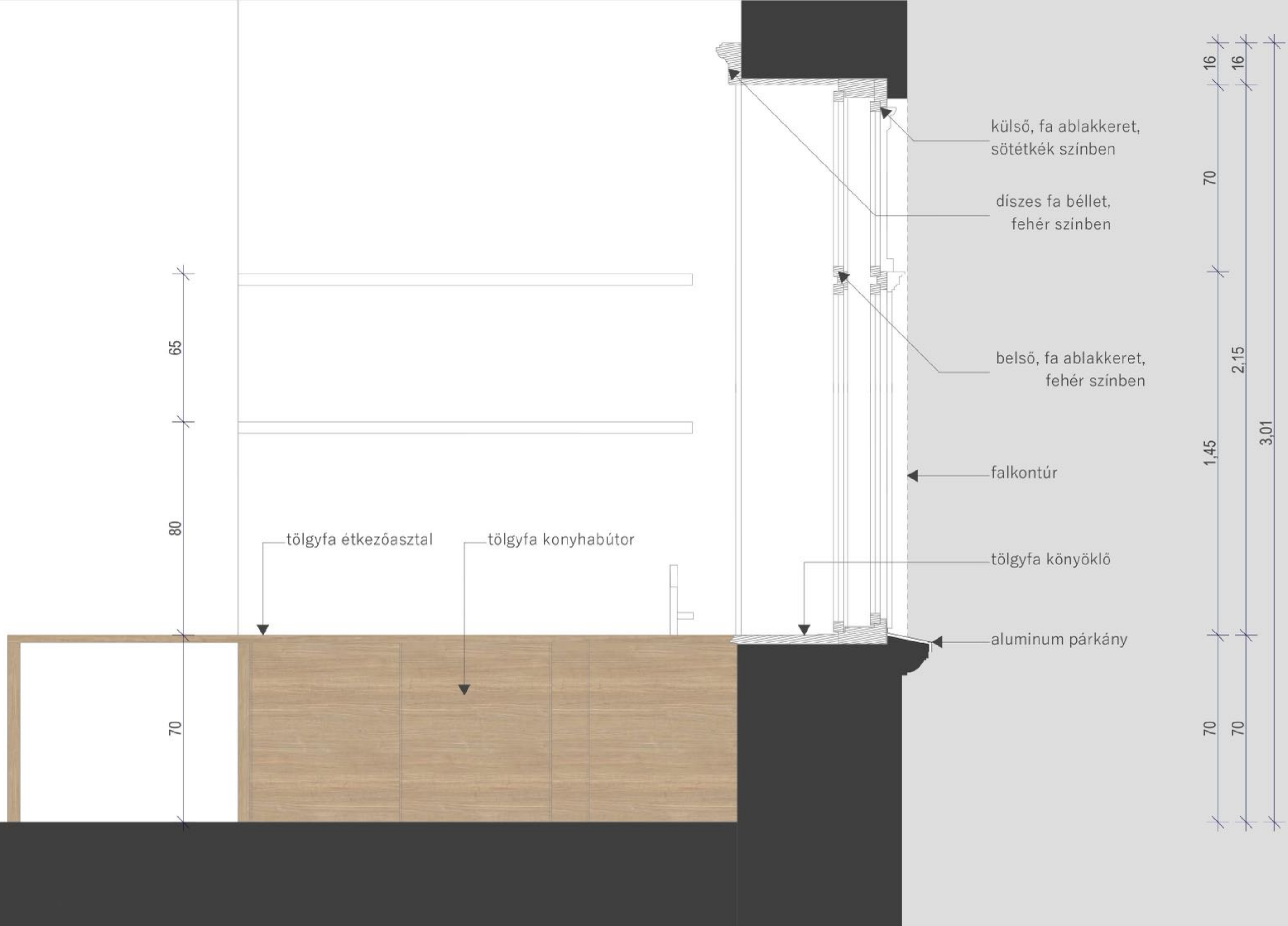

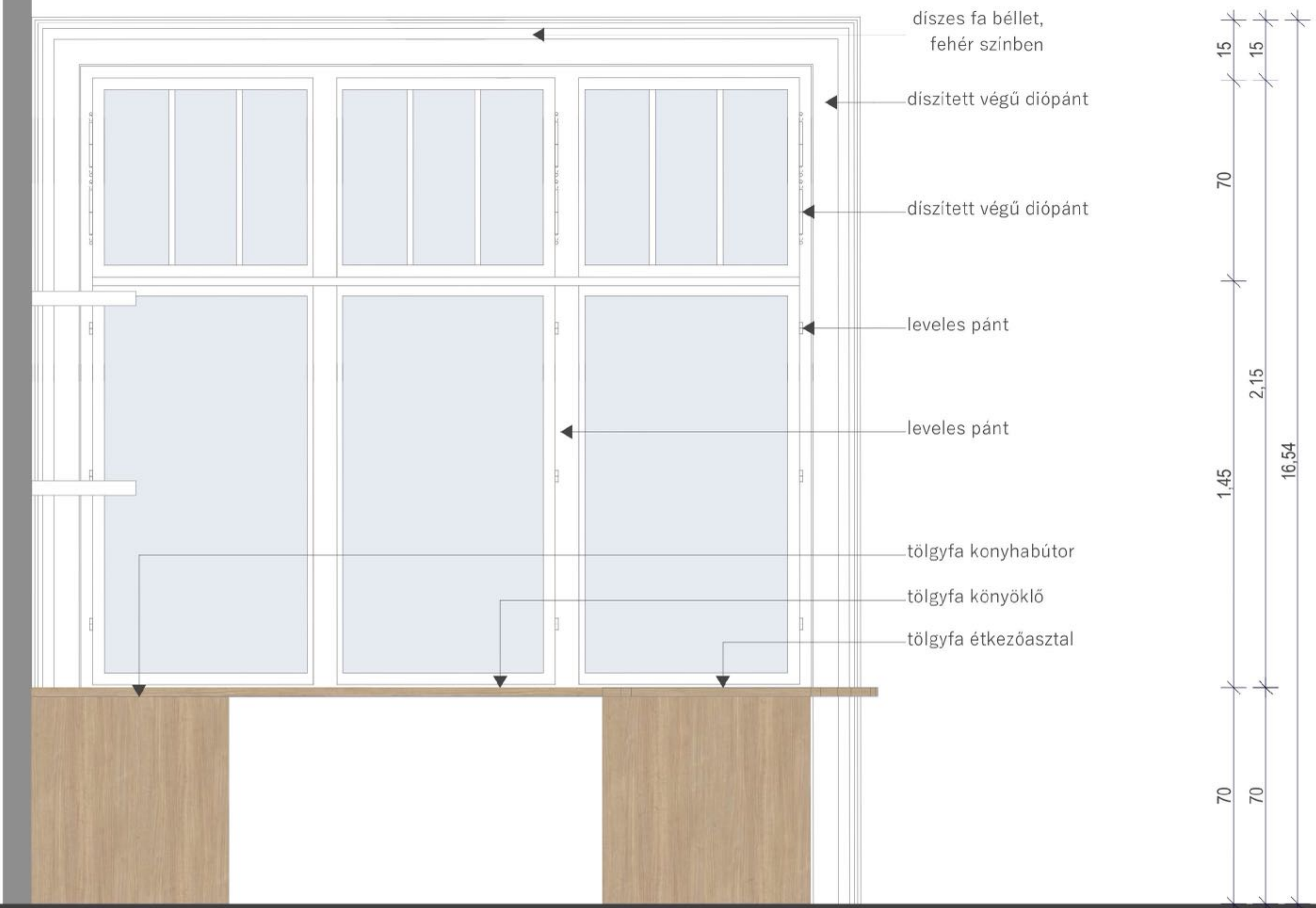

díszes fa béllet,
fehér színben

díszített végű diópánt

díszített végű diópánt

leveles pánt

leveles pánt

tölgyfa konyhabútor

tölgyfa könyöklő

tölgyfa étkezőasztal

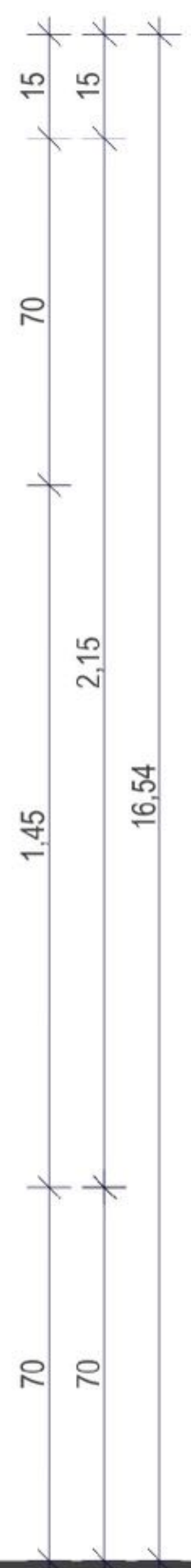

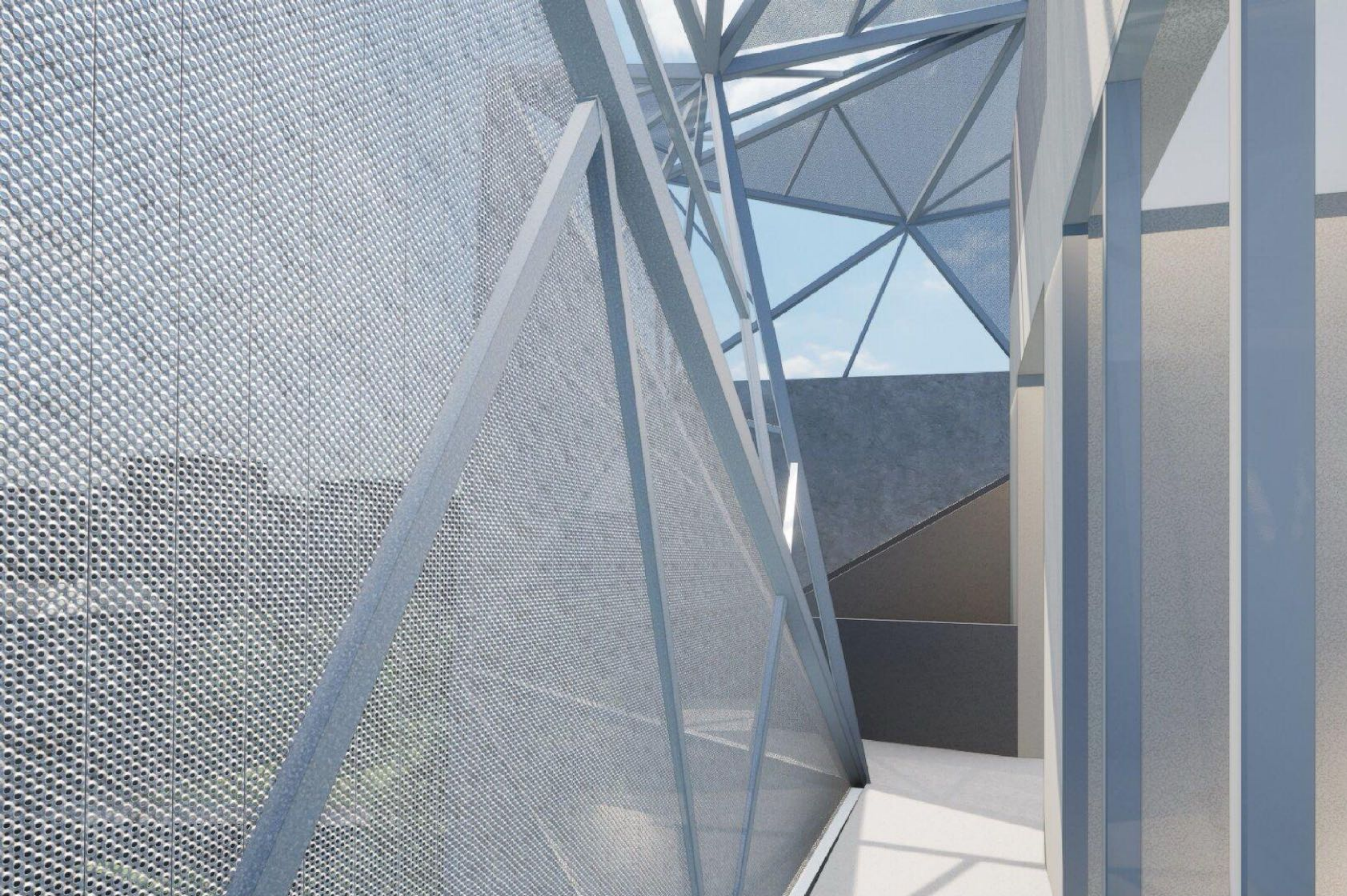



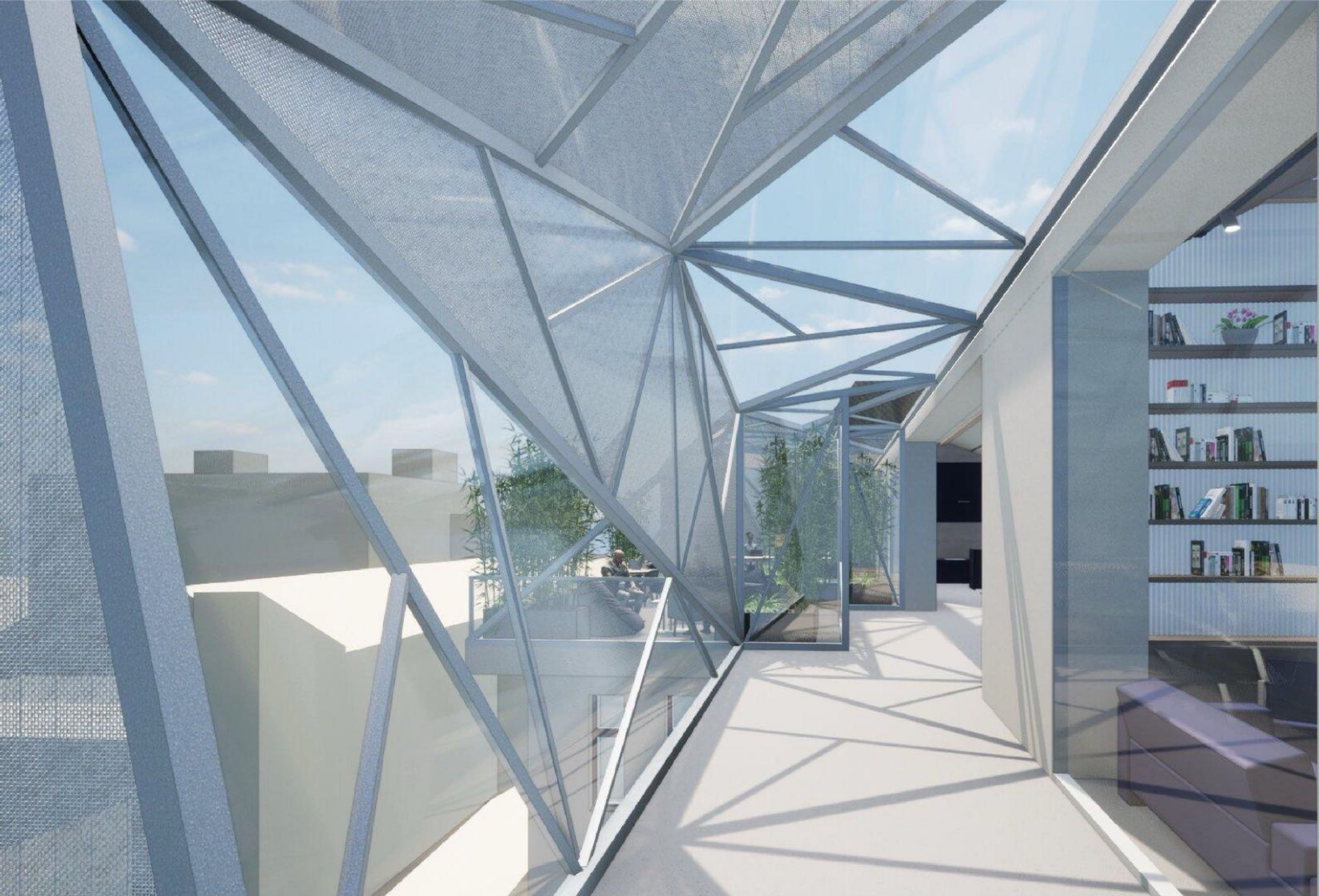



Északi homlokzat

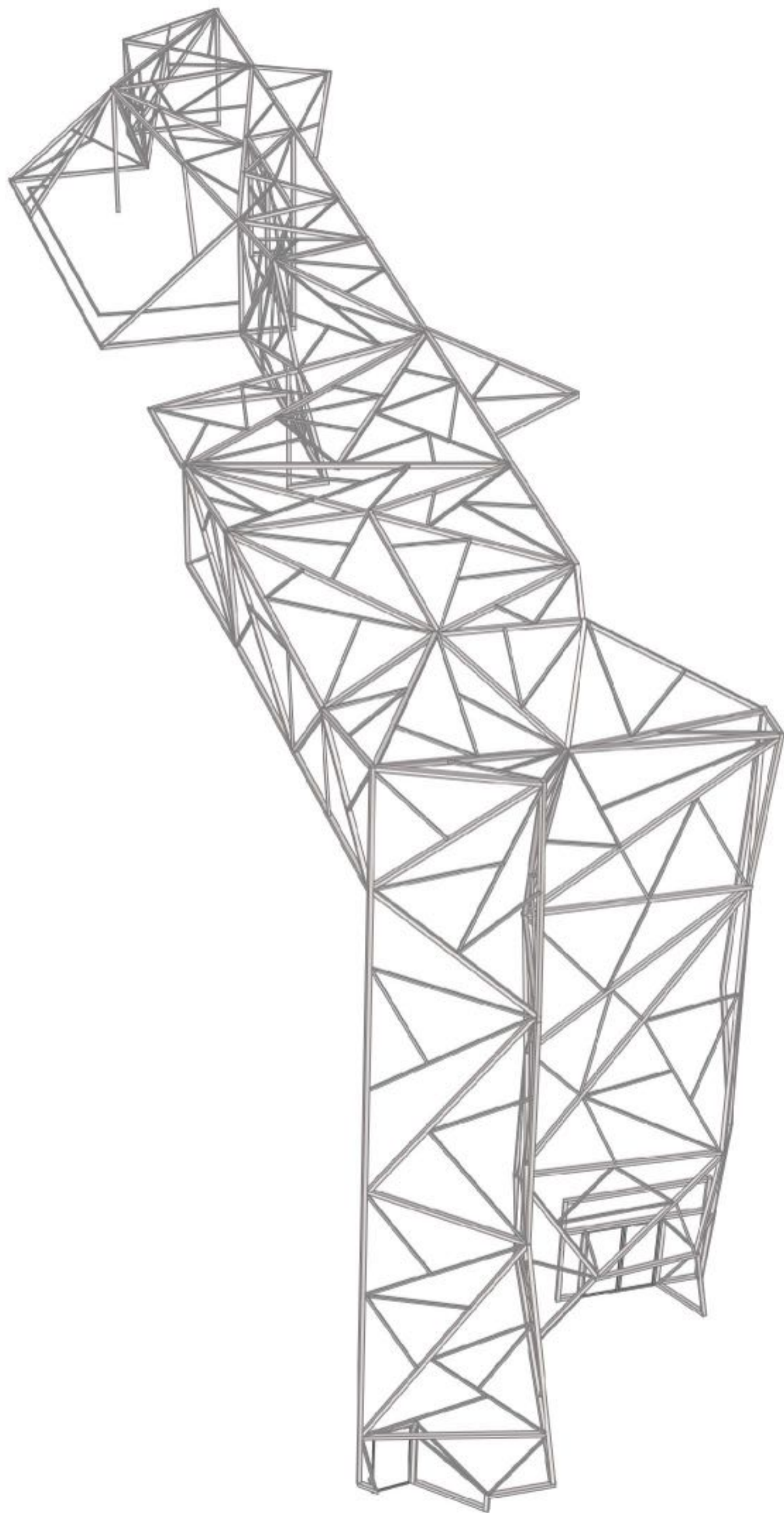

Schüco AOC 50 ST függönyfal
egyedi acél háttérszerkezettel

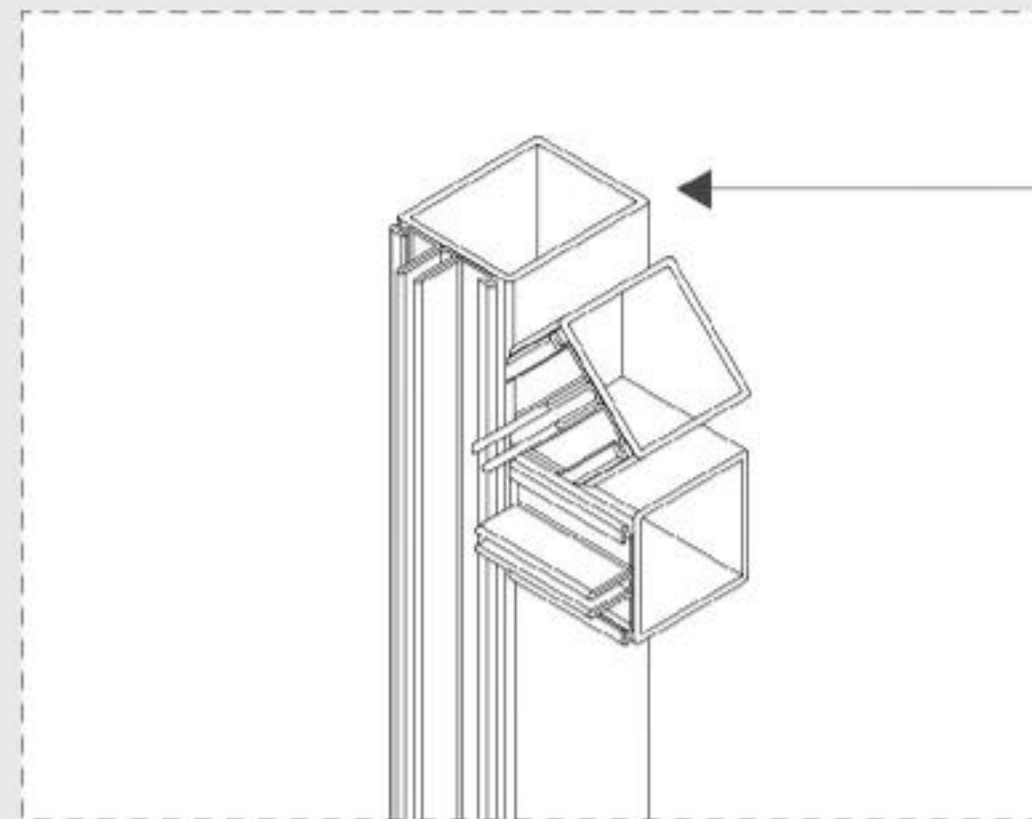

hegesztett acél
háttérszerkezet

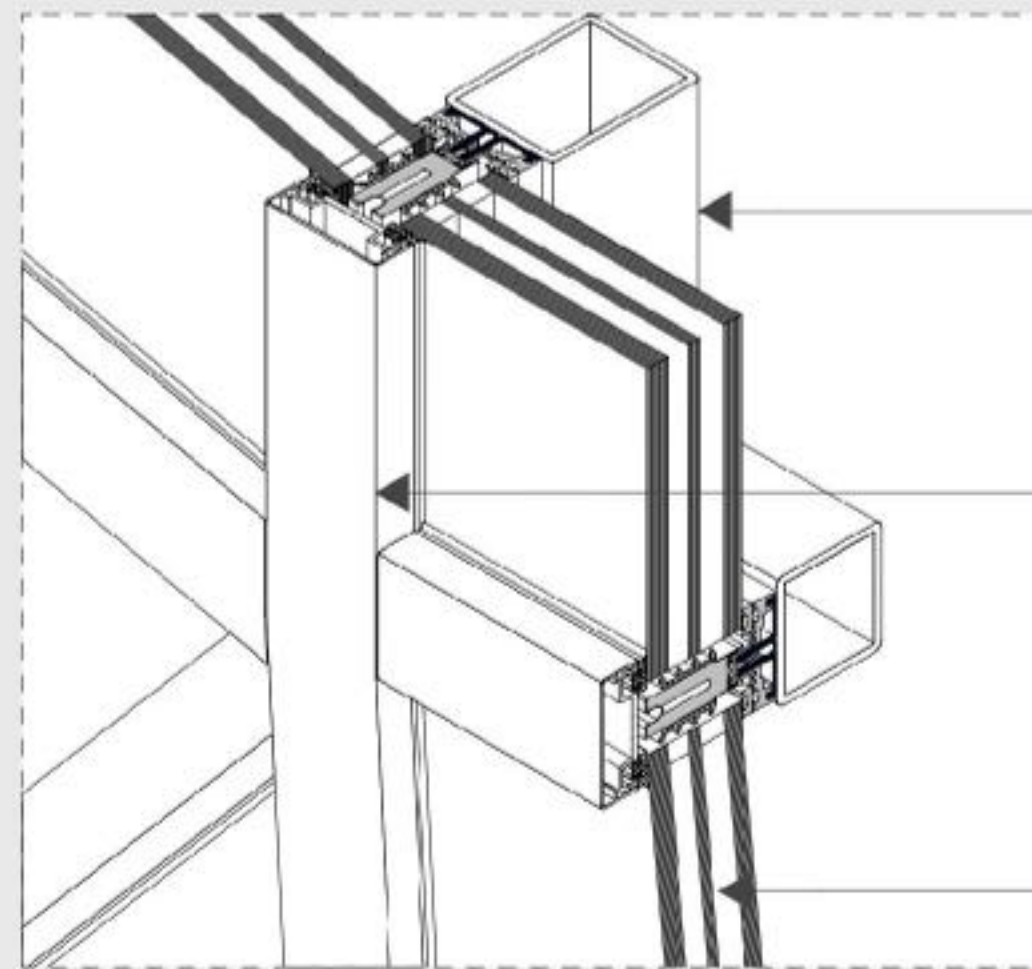

háttérszerkezet

fedősapka/takaróelem

3 rétegű elektronikusan
sötétíthető üveg

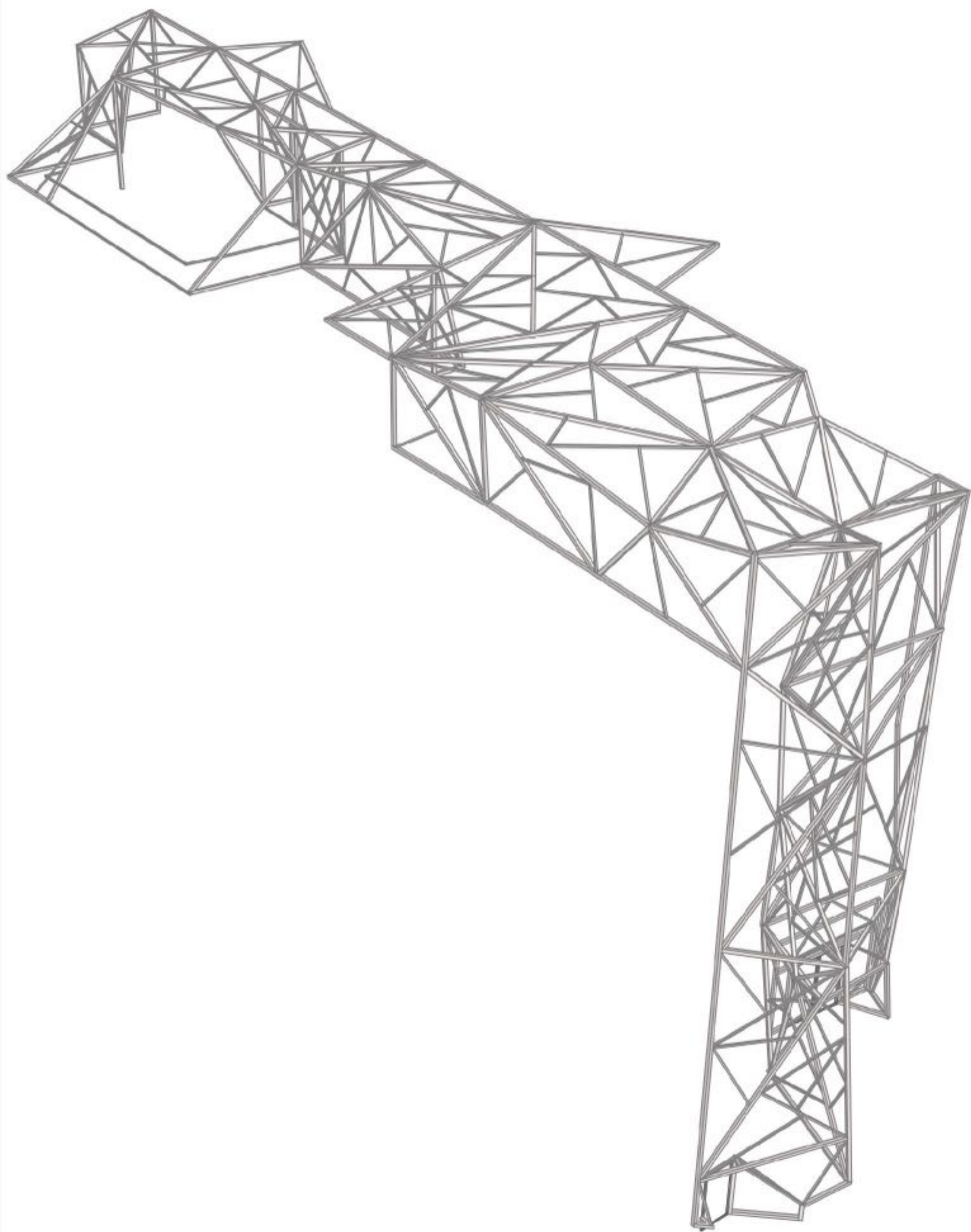

Sarkokat eltakaró elem,
mindkét oldalon változtatható szöggel

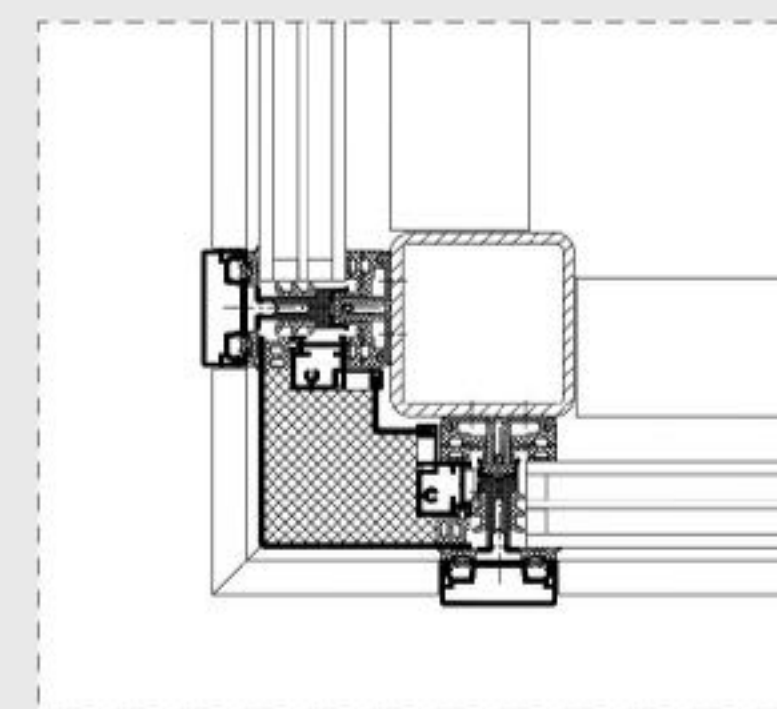
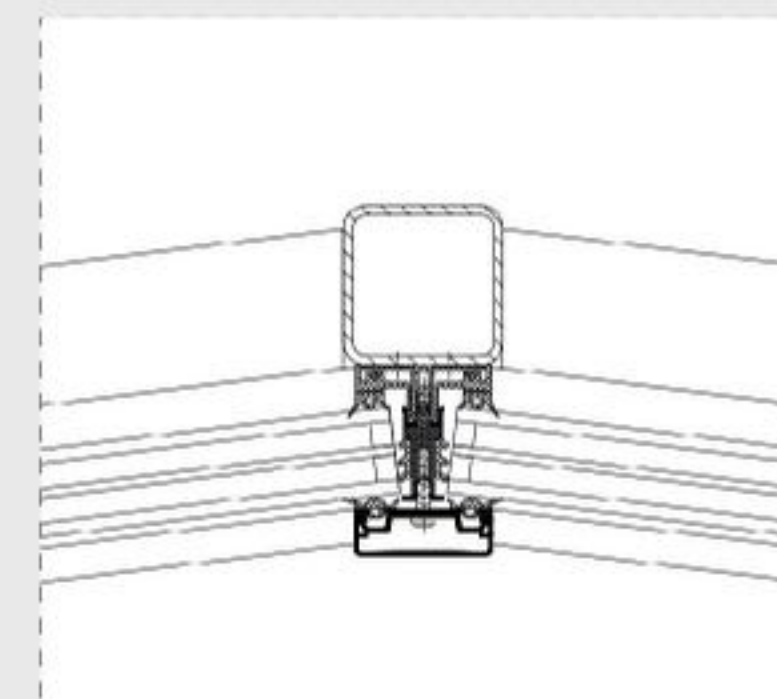
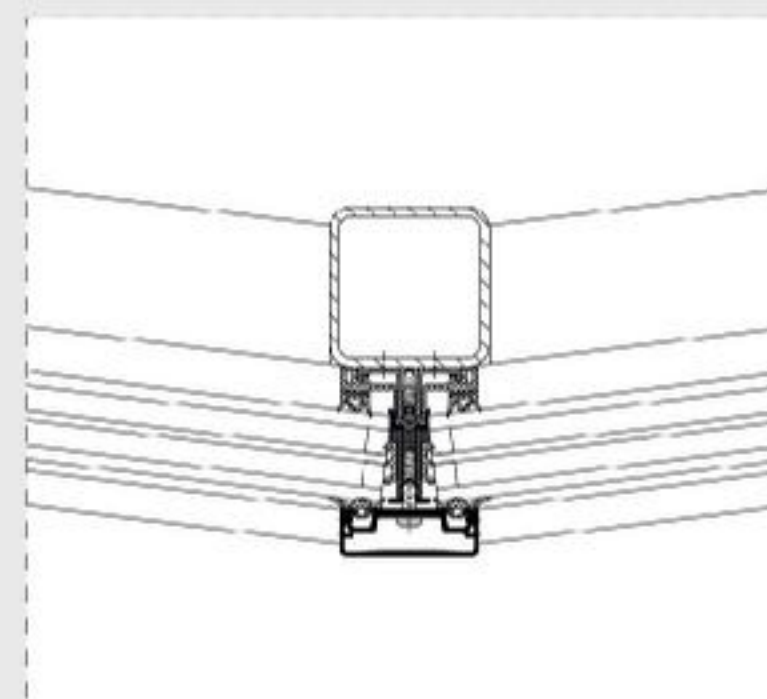
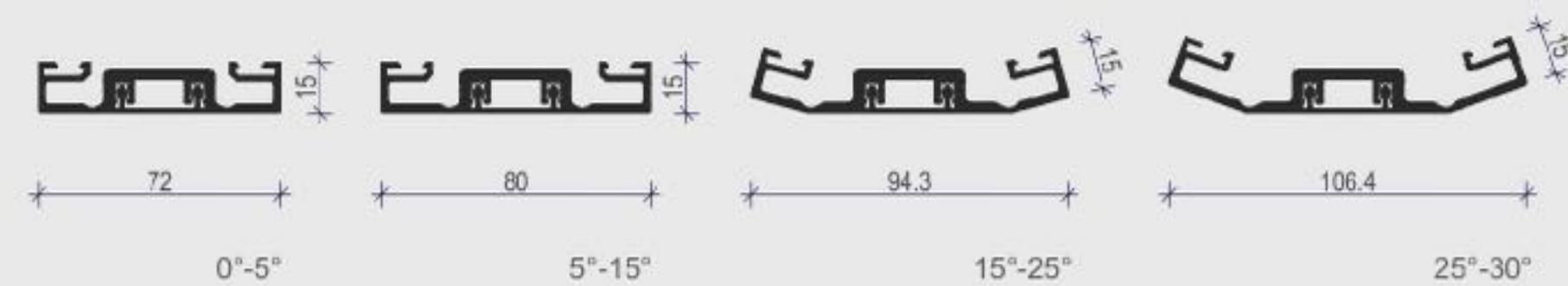



Gépezeti helyiség

Külső akna

Külső árnyékoló

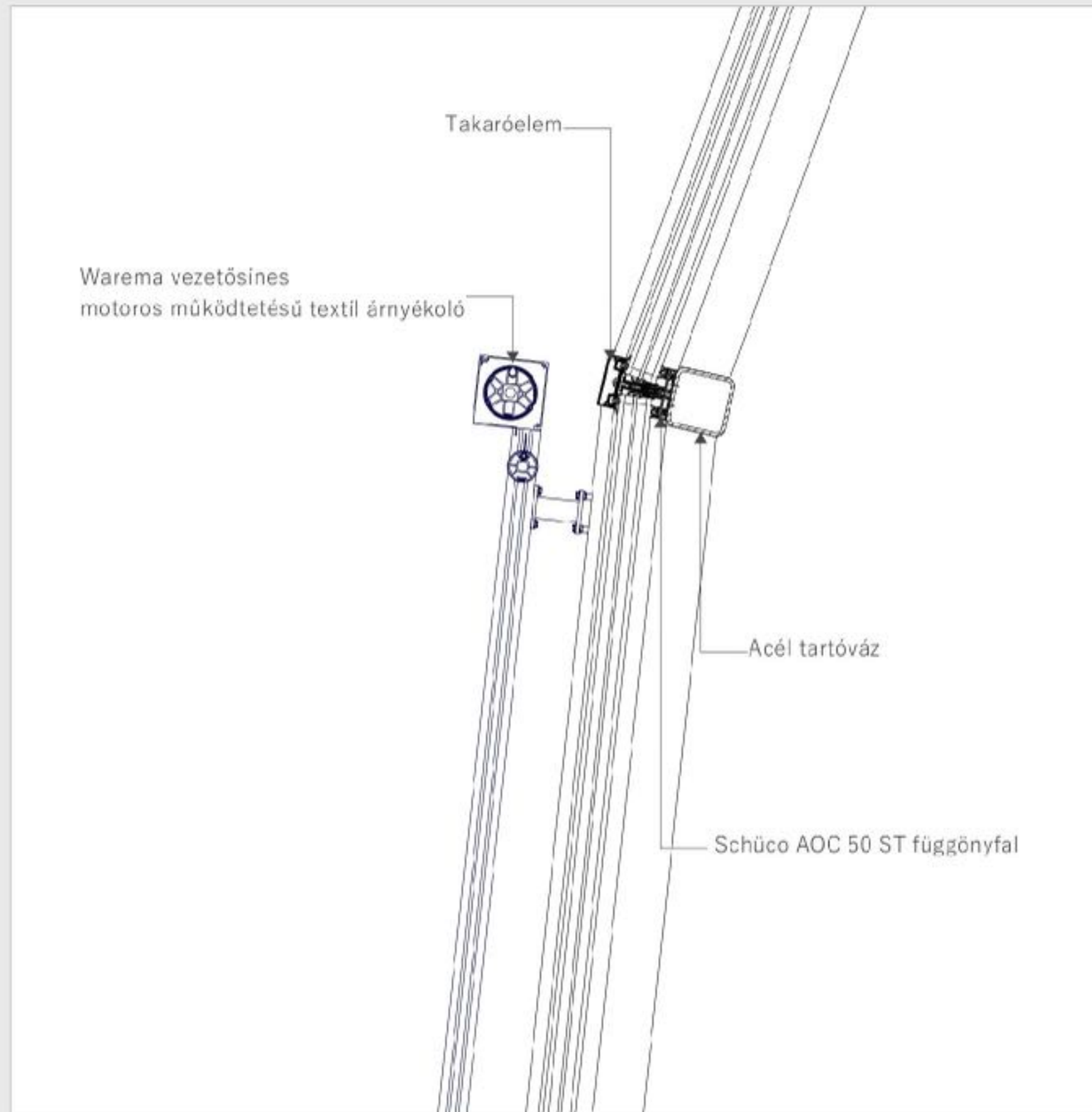

Beltéri árnyékoló

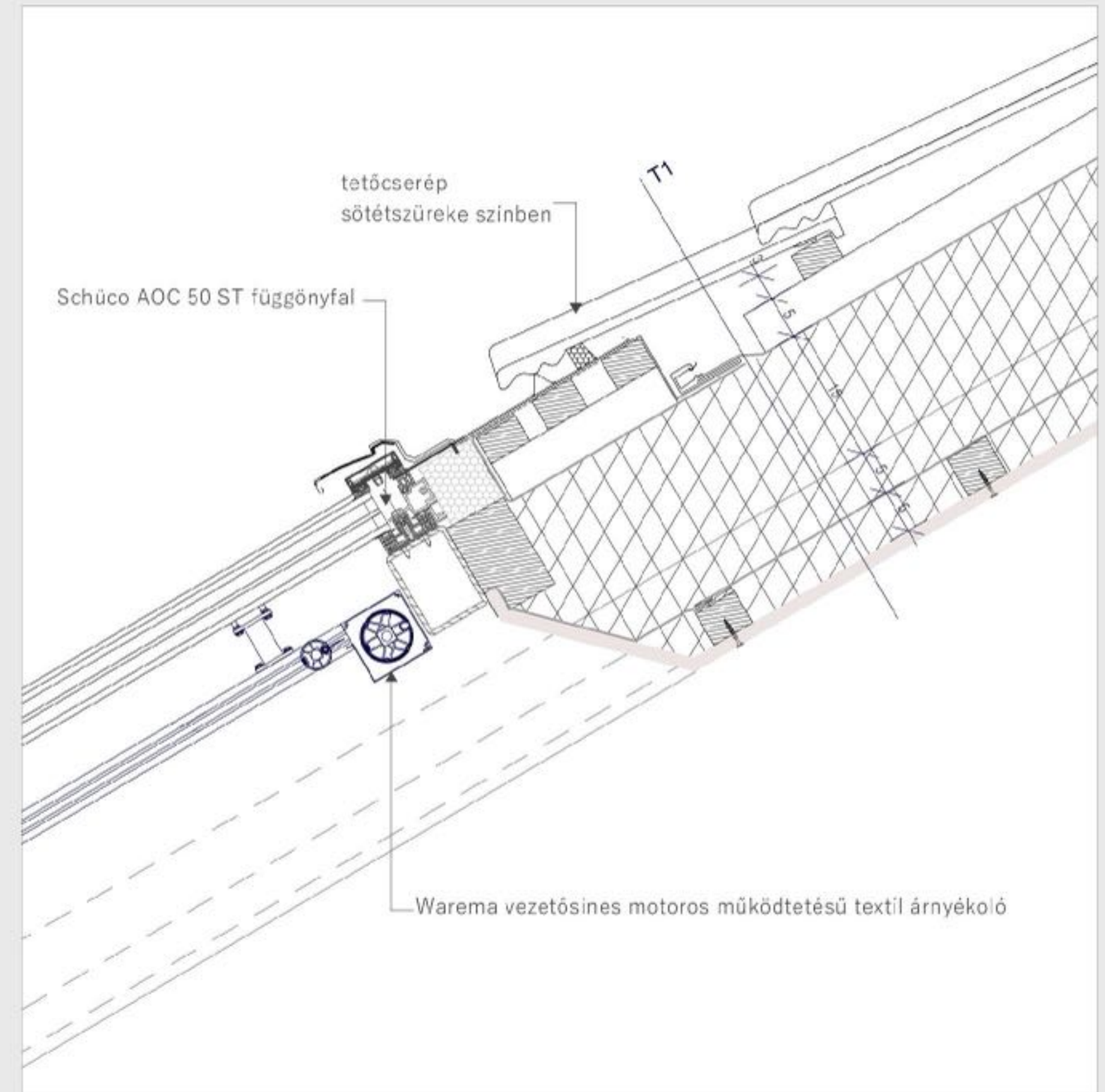



Tető látványterv

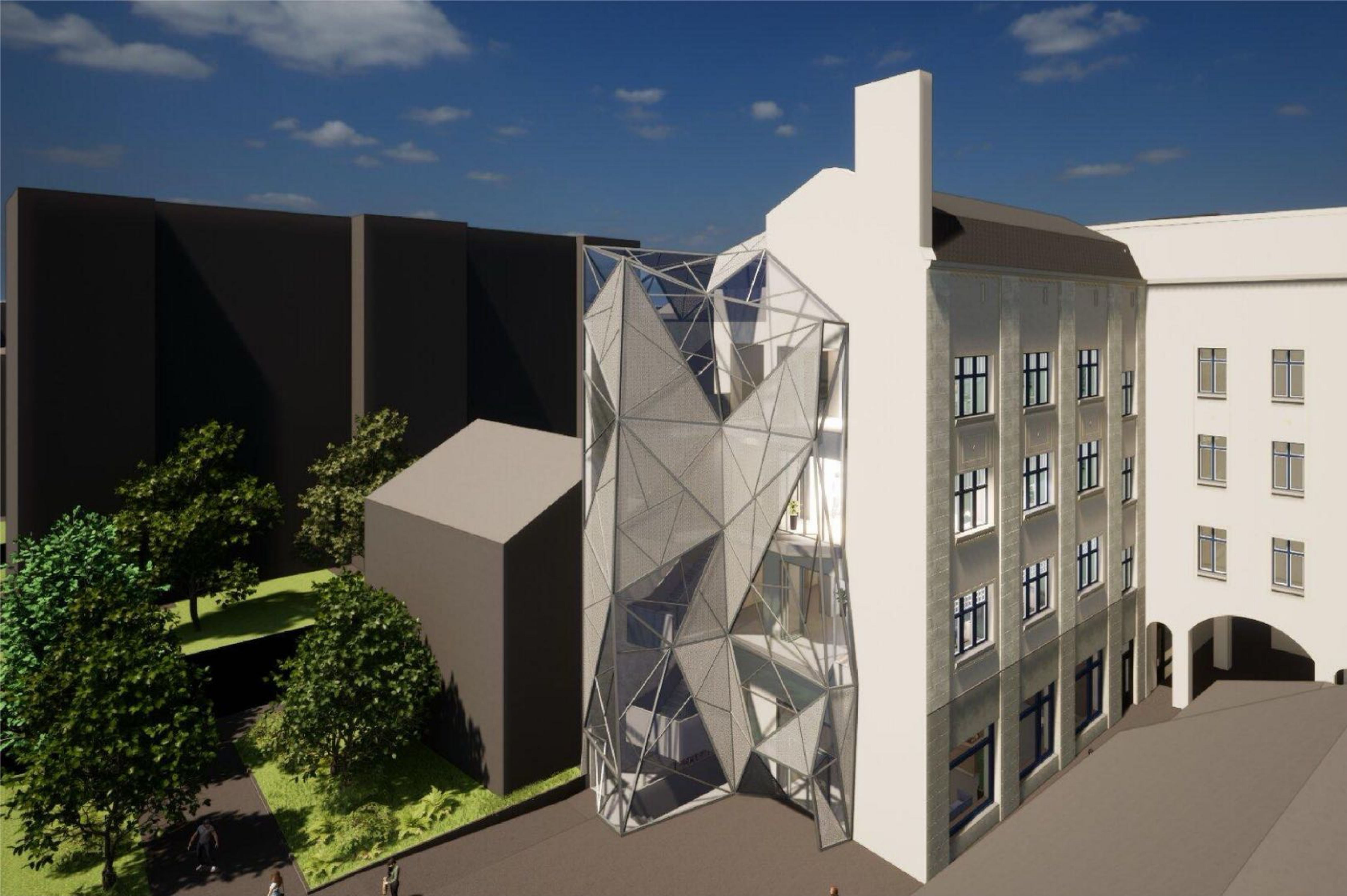

Tető látványterv

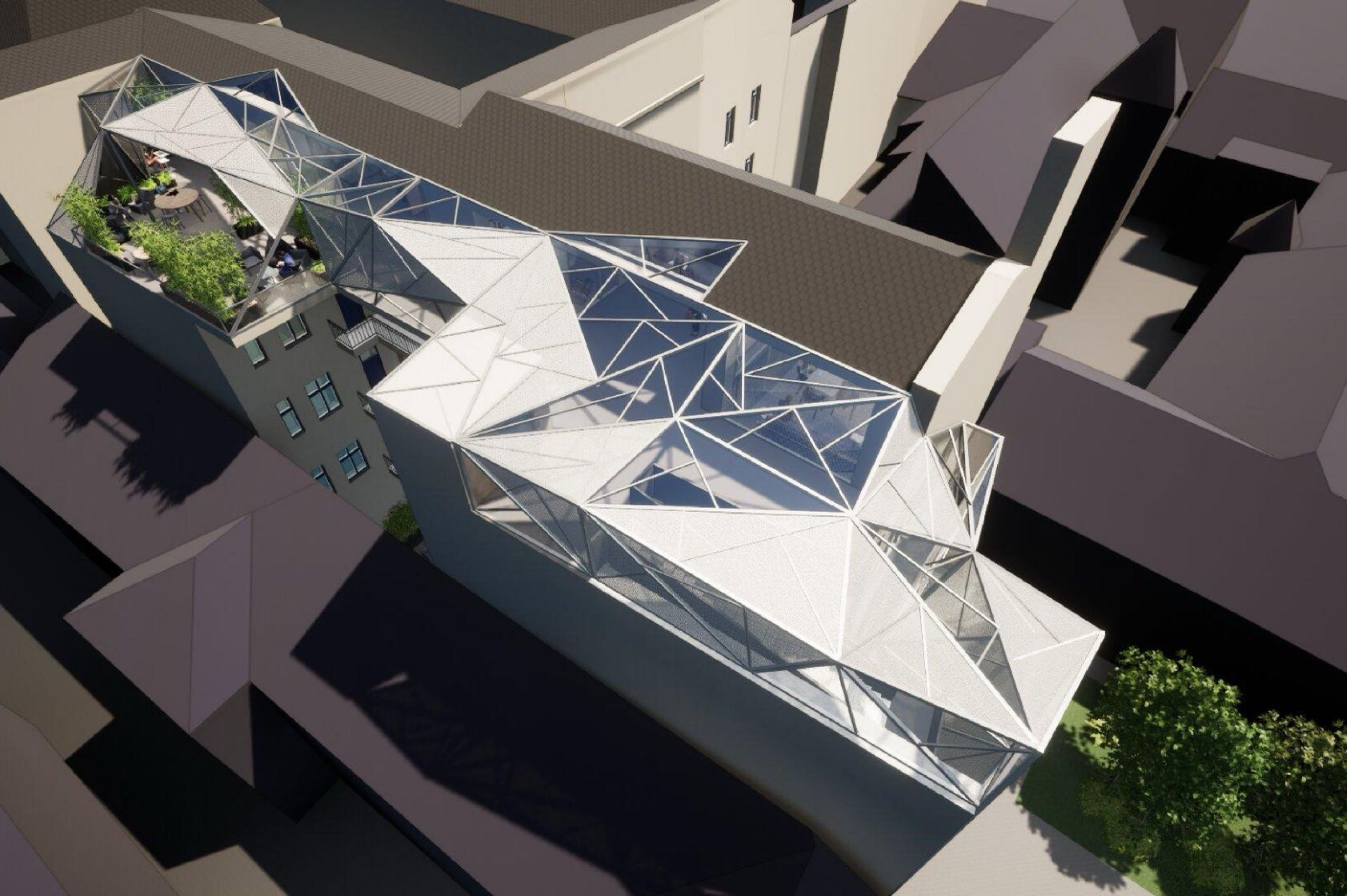

Tető látványterv



Tető látványterv



Meglévő északi homlokzat



