

ERDŐKERT

KISKÖRÖS - TANGAZDASÁG

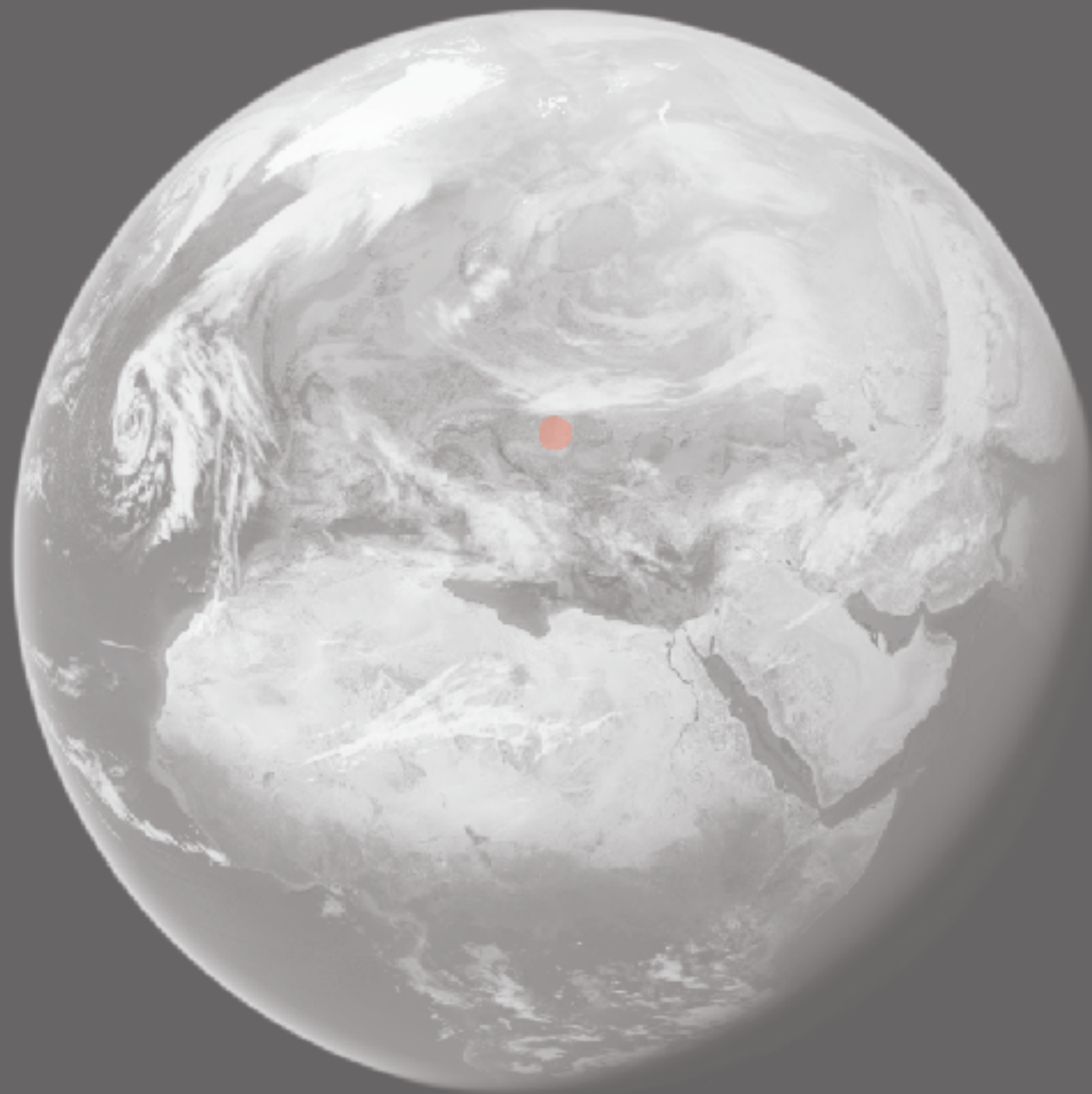

TERVEZÉSI TERÜLET FEKVÉSE



TERVEZÉSI TERÜLET FEKVÉSE



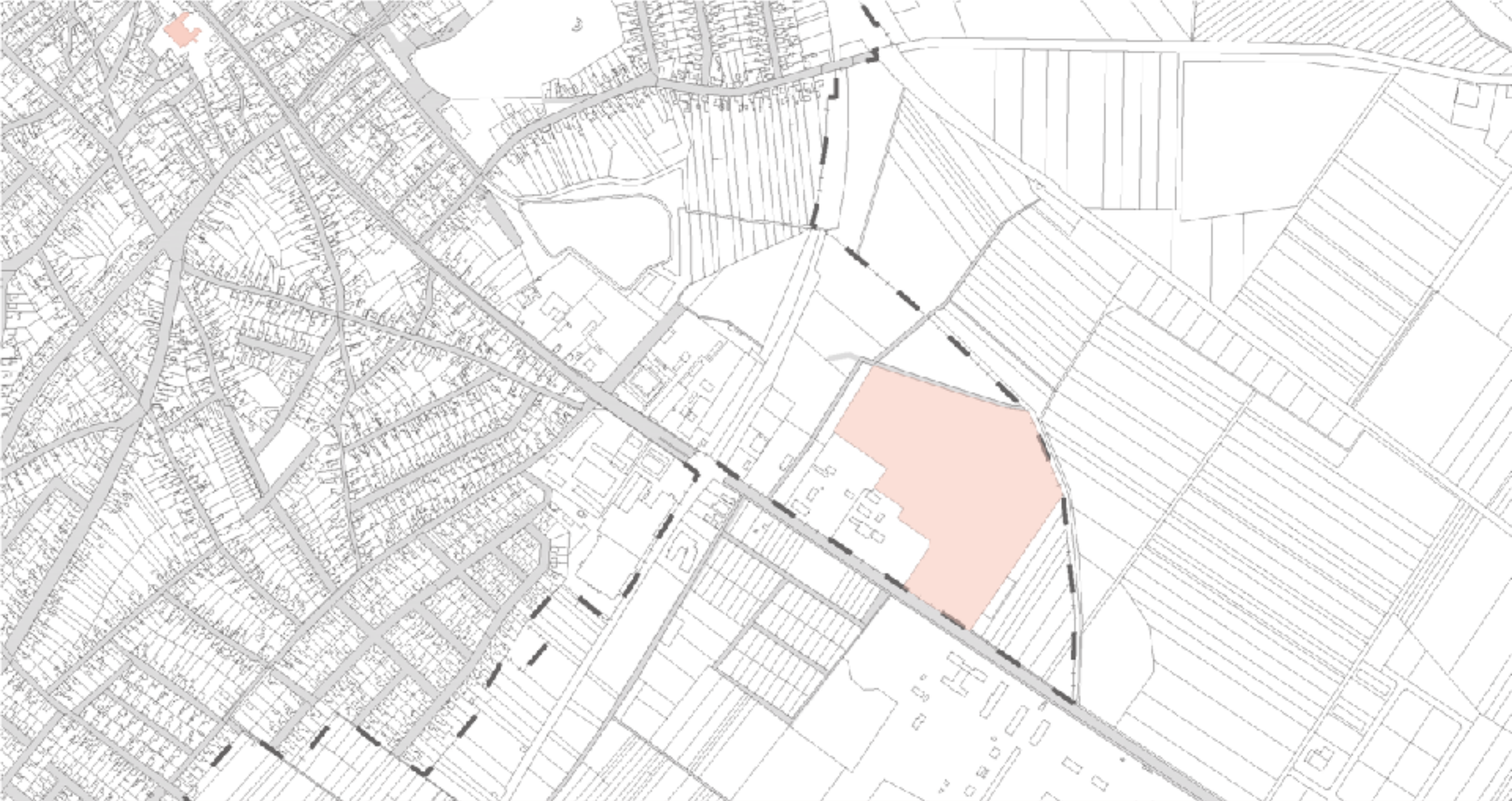

TERVEZÉSI TERÜLET FEKVÉSE



TERVEZÉSI TERÜLET FEKVÉSE

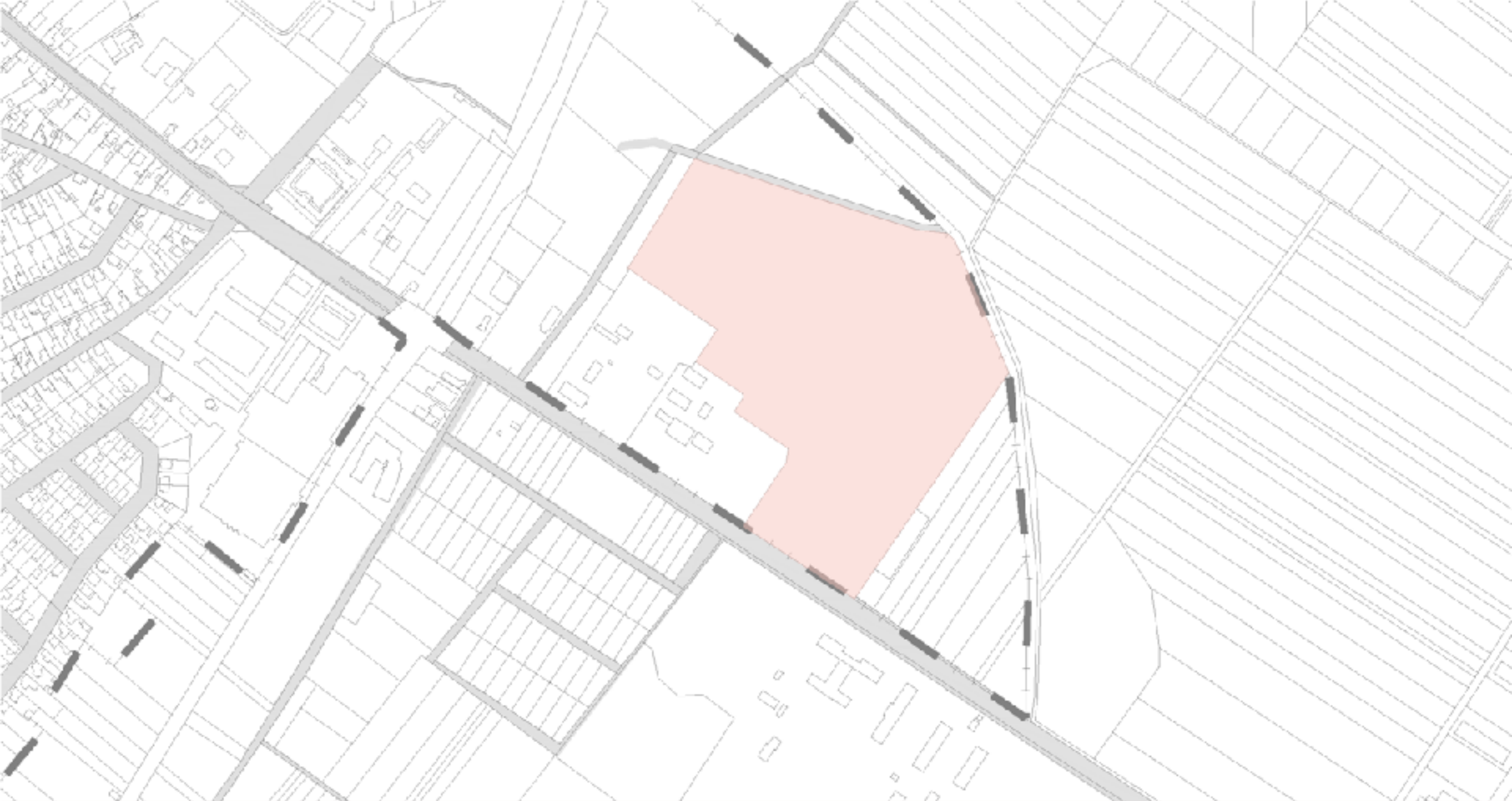

TERVEZÉSI TERÜLET FEKVÉSE



HELYSZÍN JELENLEGI ÁLLAPOTA



HELYSZÍN JELENLEGI ÁLLAPOTA



HELYSZÍN JELENLEGI ÁLLAPOTA



HELYSZÍN JELENLEGI ÁLLAPOTA



HELYSZÍN JELENLEGI ÁLLAPOTA



HELYSZÍN JELENLEGI ÁLLAPOTA



HELYSZÍN JELENLEGI ÁLLAPOTA

TERVEZÉSI PROGRAM

Épített terek

oktatási
szállás
gazdálkodáshoz kapcsolódó
kézműves
tárolás
képzés
kiszolgáló

Átmeneti terek

szabadidő
közösségi
előadás
feldolgozás

Kijelölt terek

növénytermesztés
kísérleti

KÖZÖS TETŐ ALÁ HOZOTT ELTÉRŐ HASZNÁLATÚ TEREK

























fák, facsoportok



cserjék



bokrok



mező



tó



kiszorgáló részek



központi tömeg



ösvények

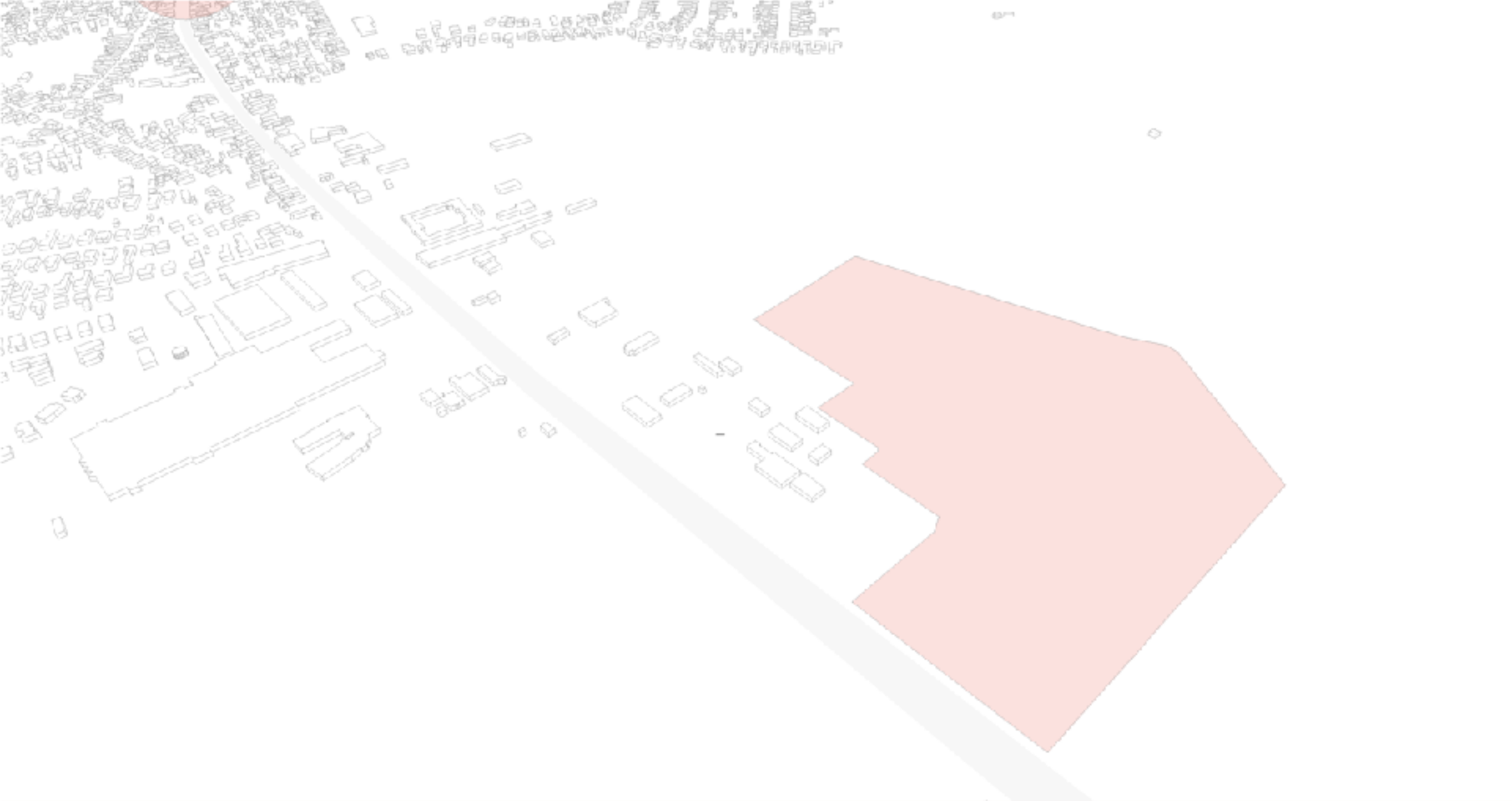

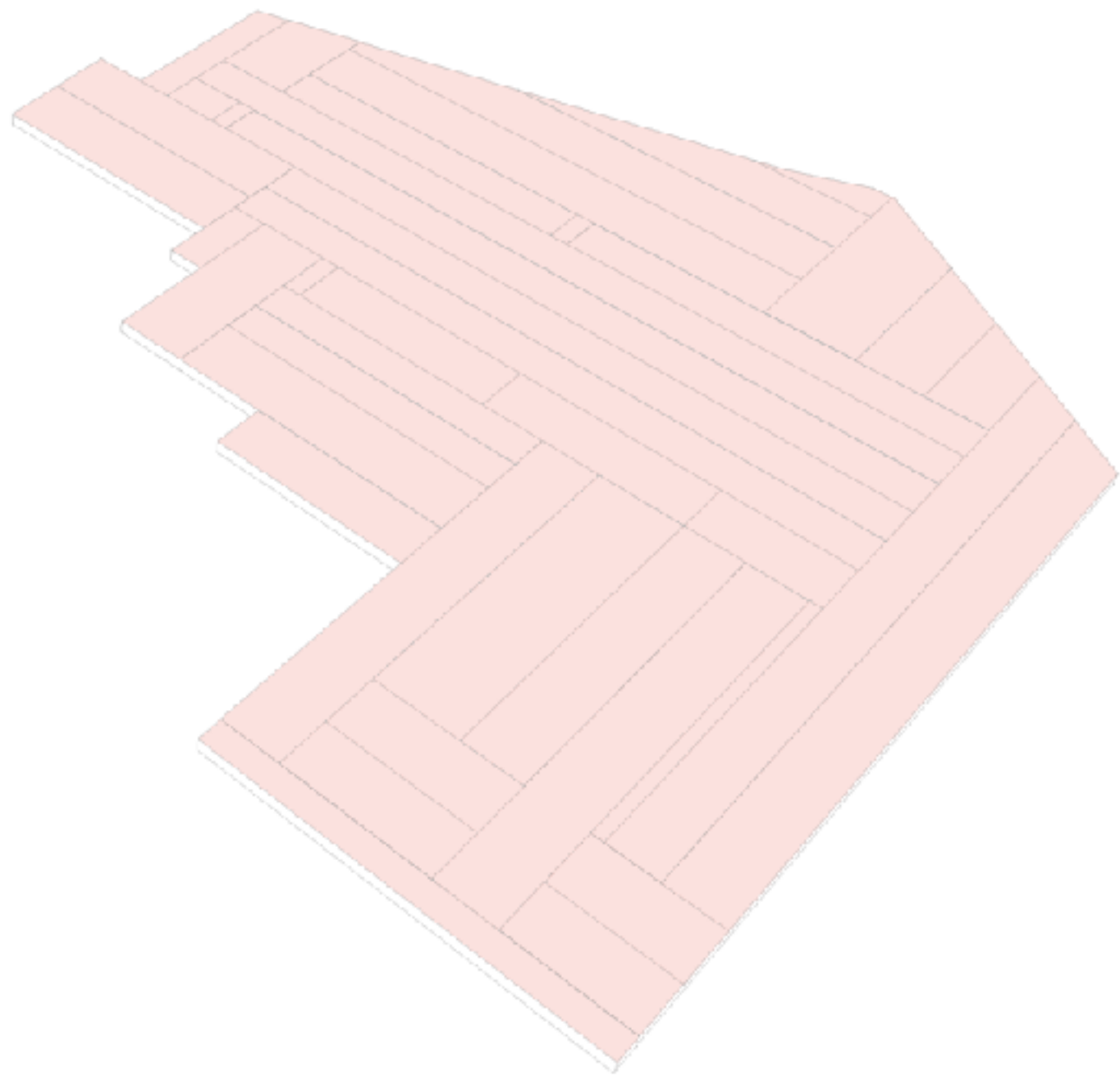

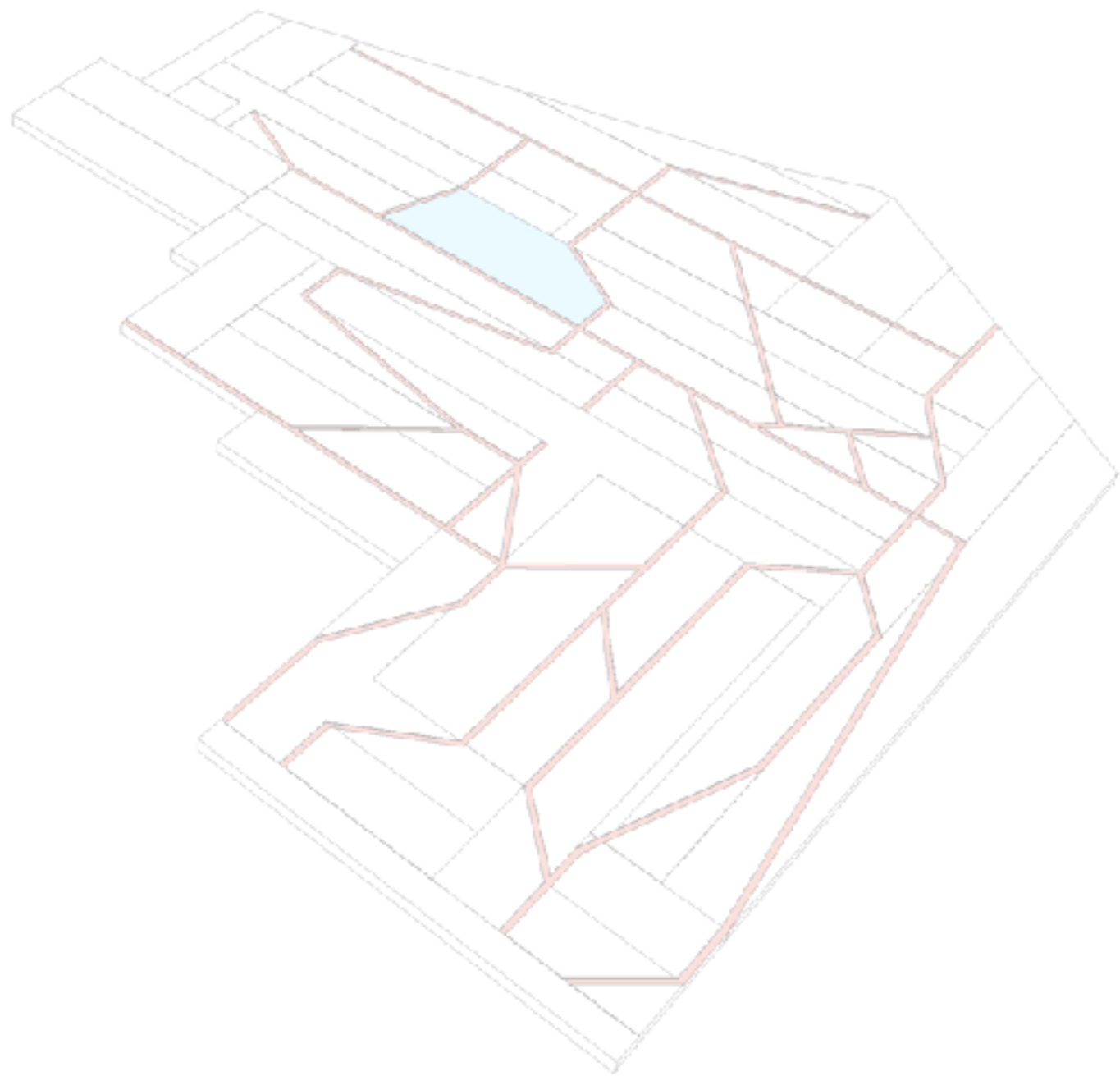





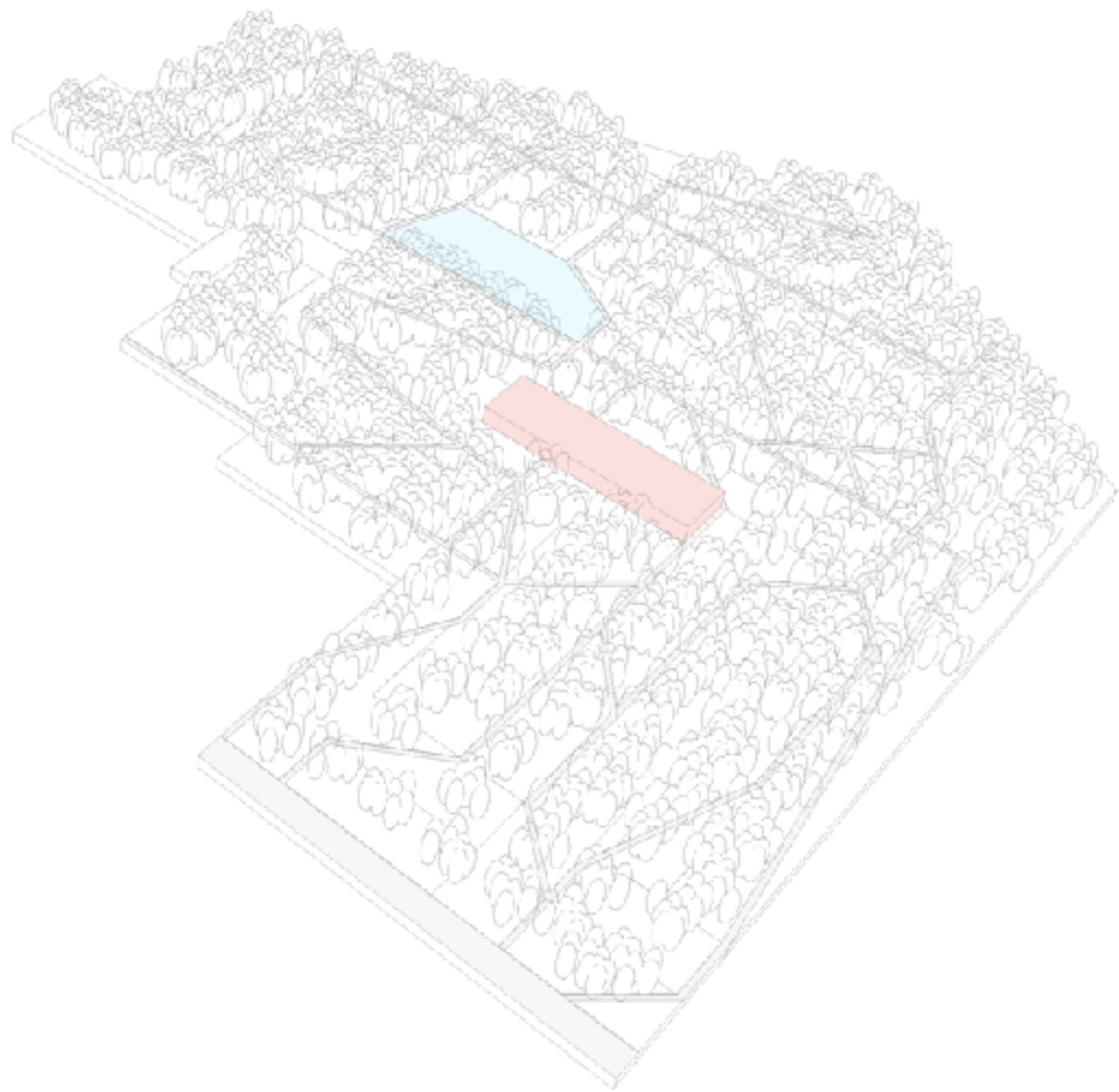

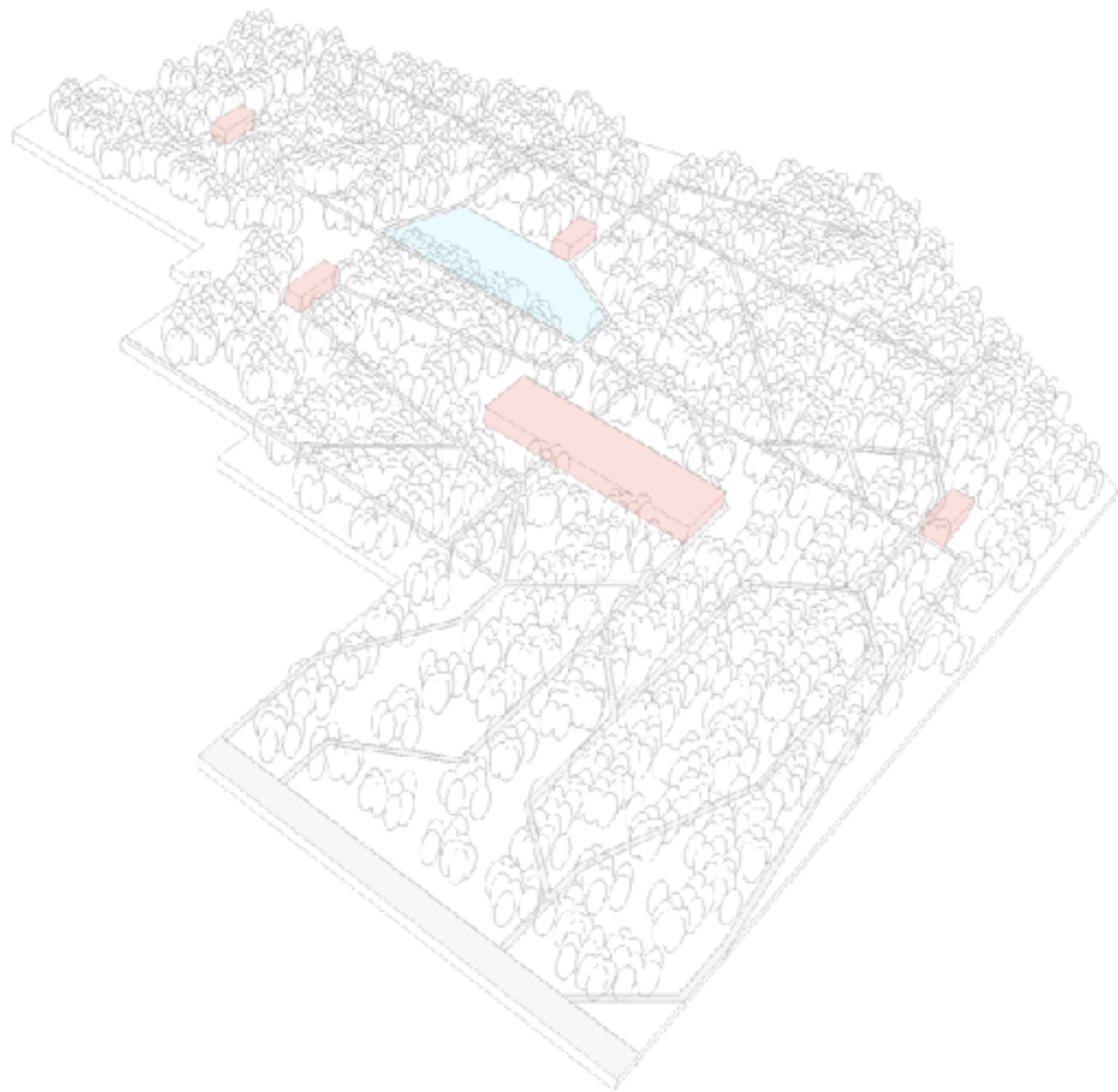

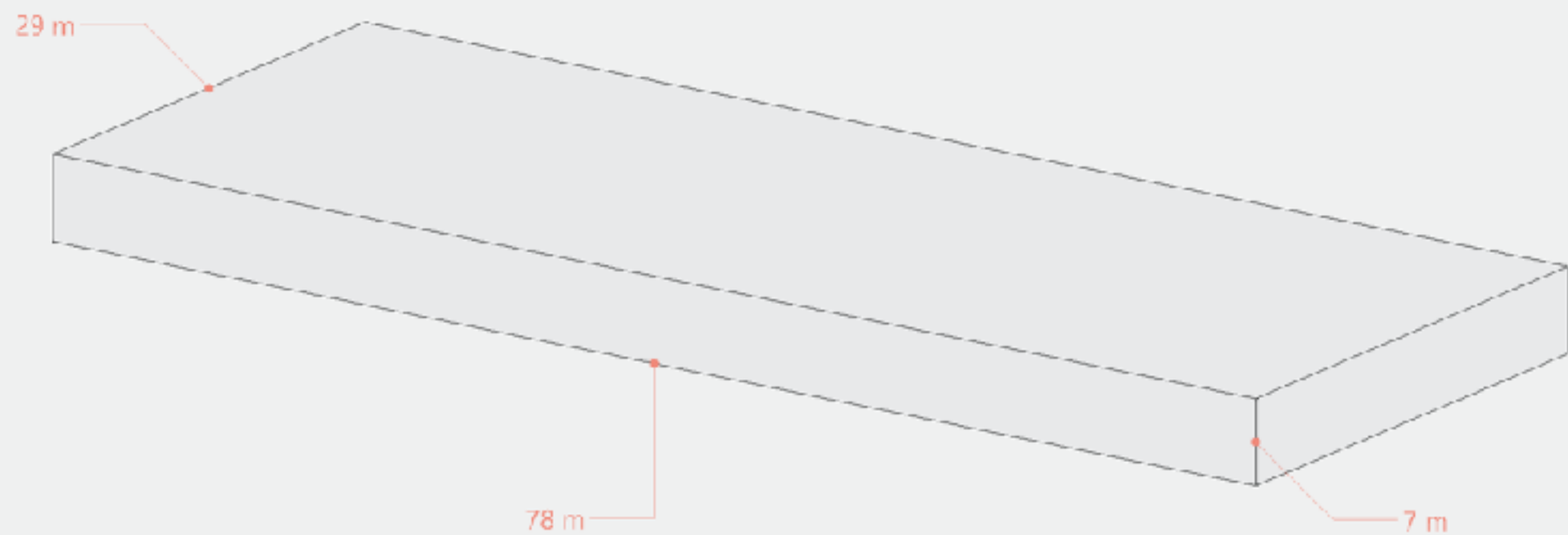

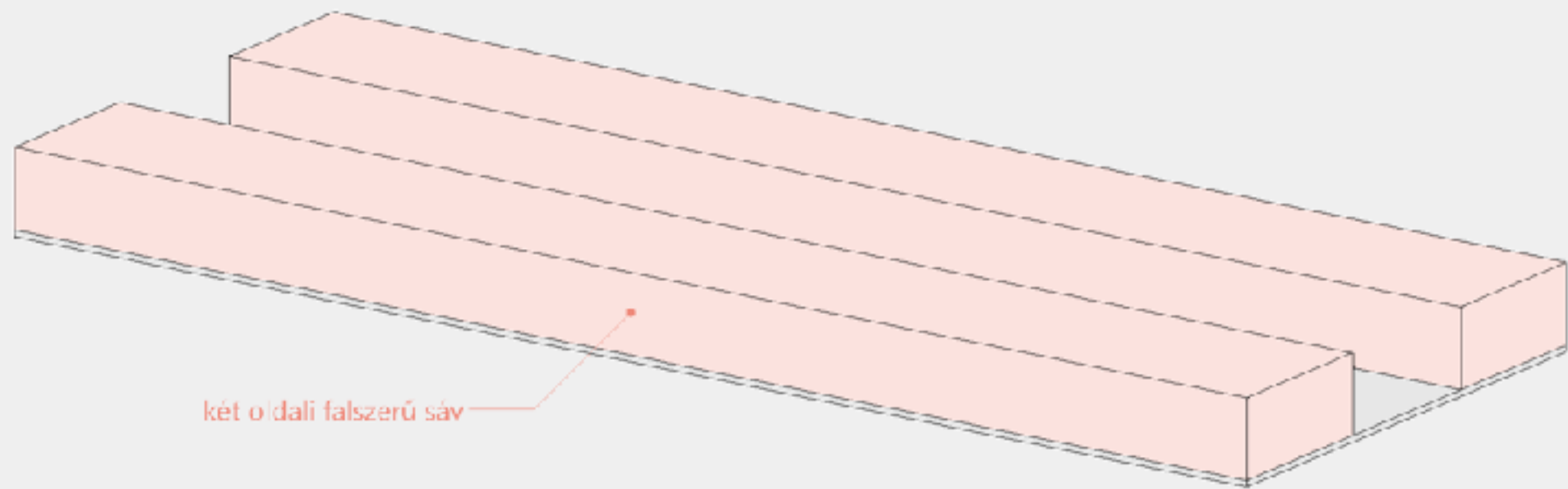

két oldali falszerű sáv

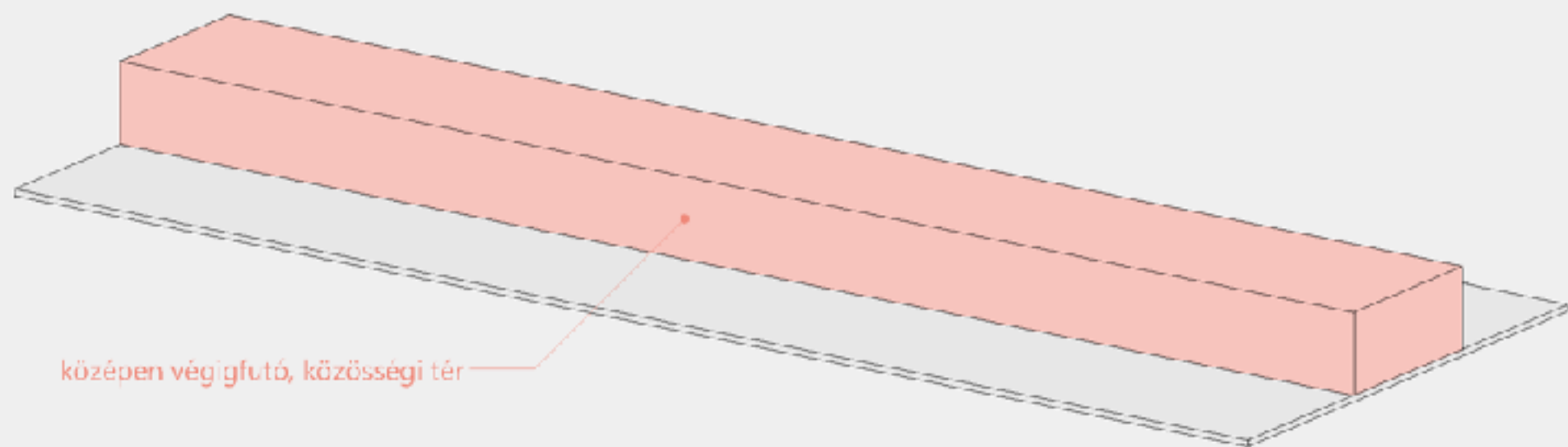

középen végigfutó, közösségi tér

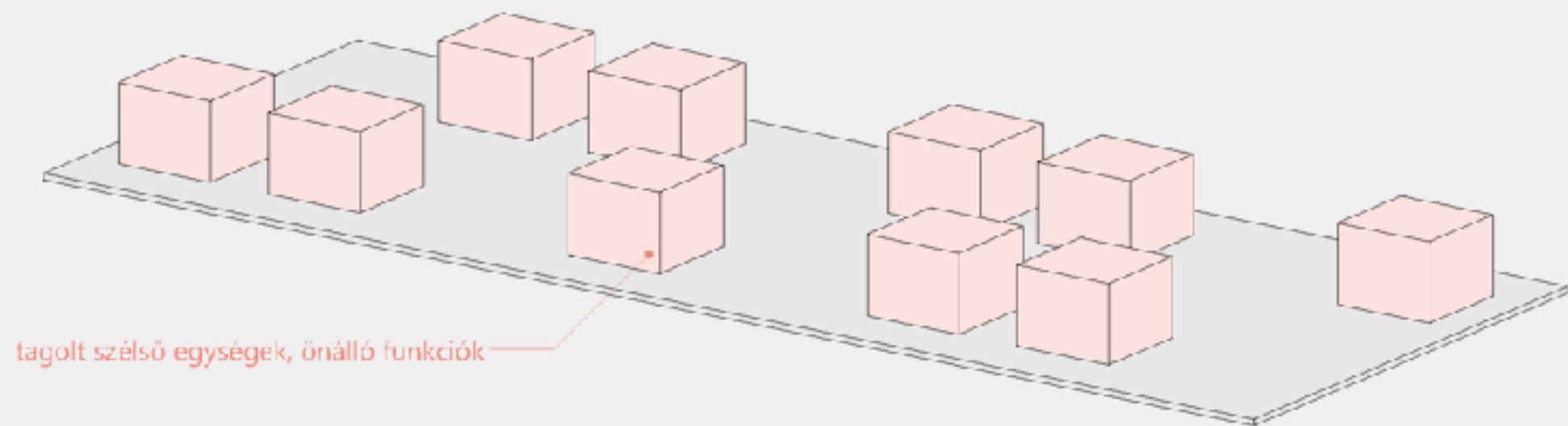

tagolt szélső egységek, önálló funkciók

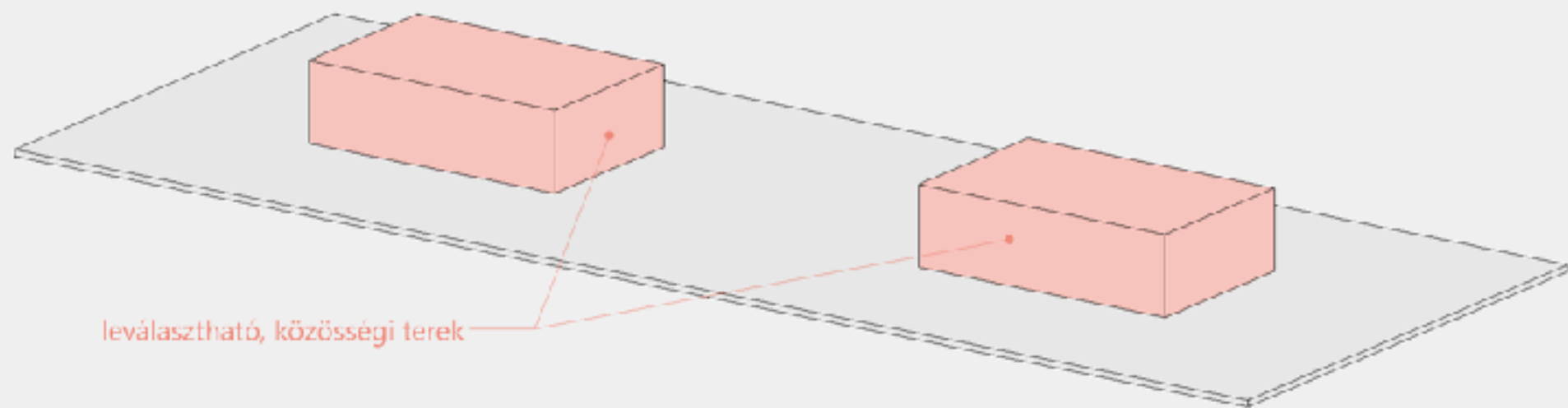

leválasztható, közösségi terek

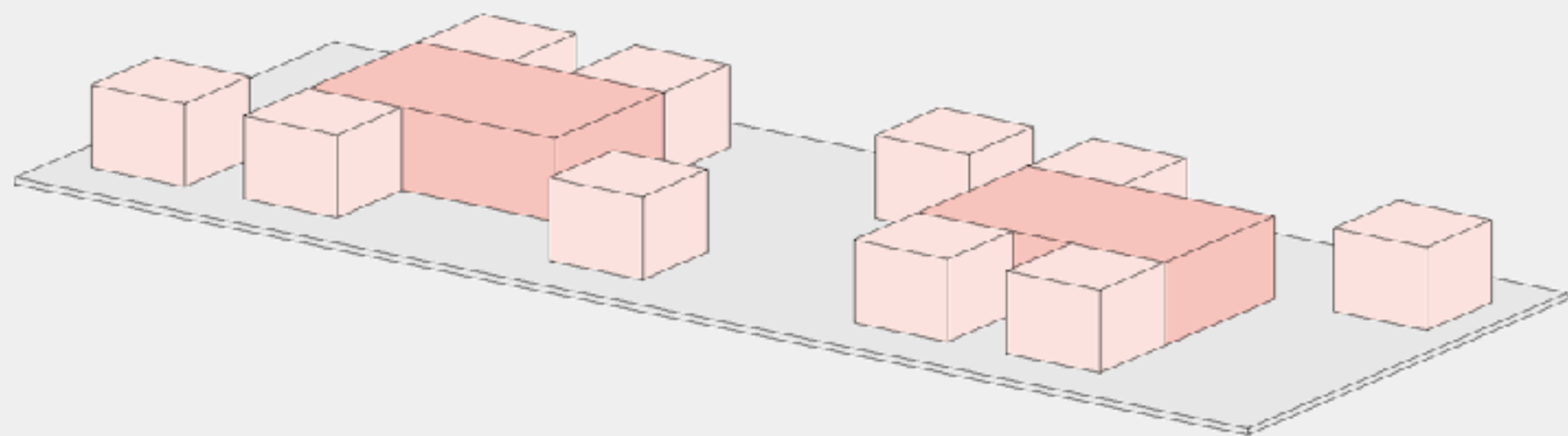

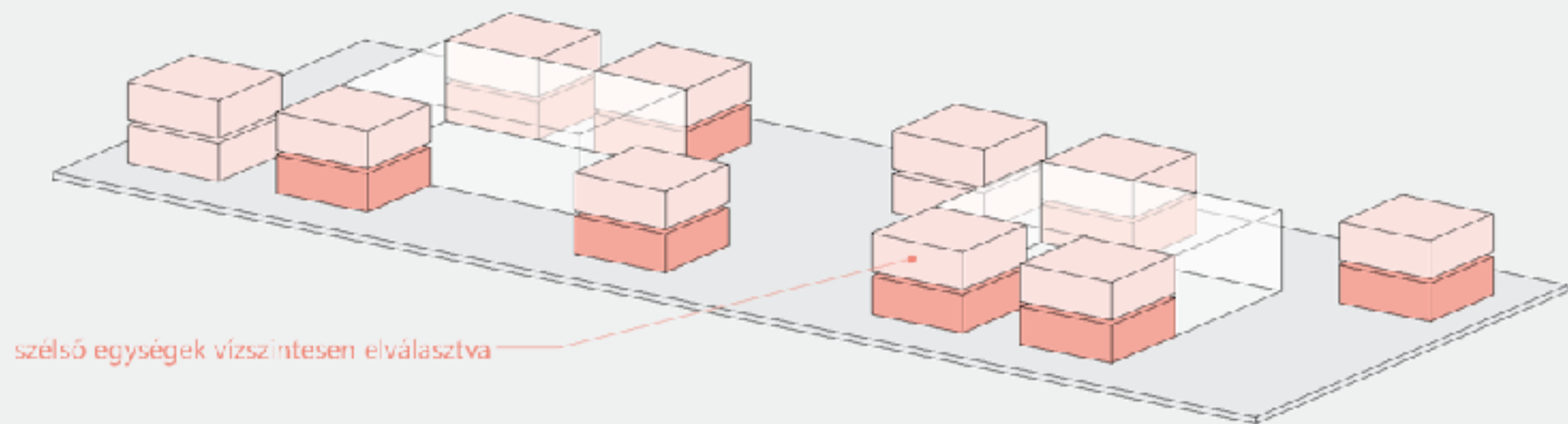

szélső egységek vízszintesen elválasztva

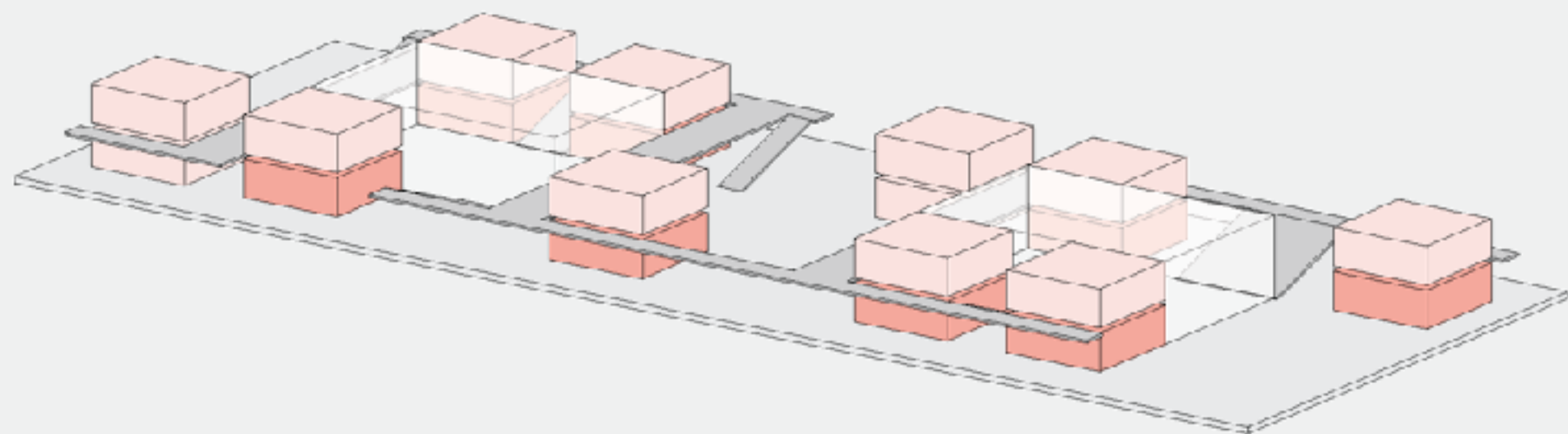

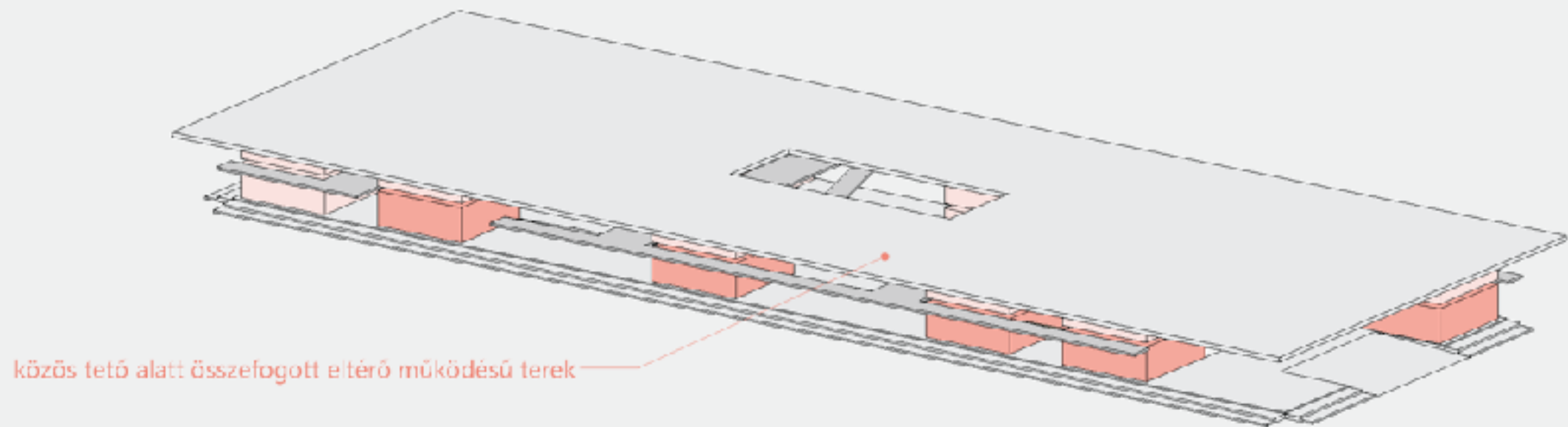

közös tető alatt összefogott eltérő működésű terek

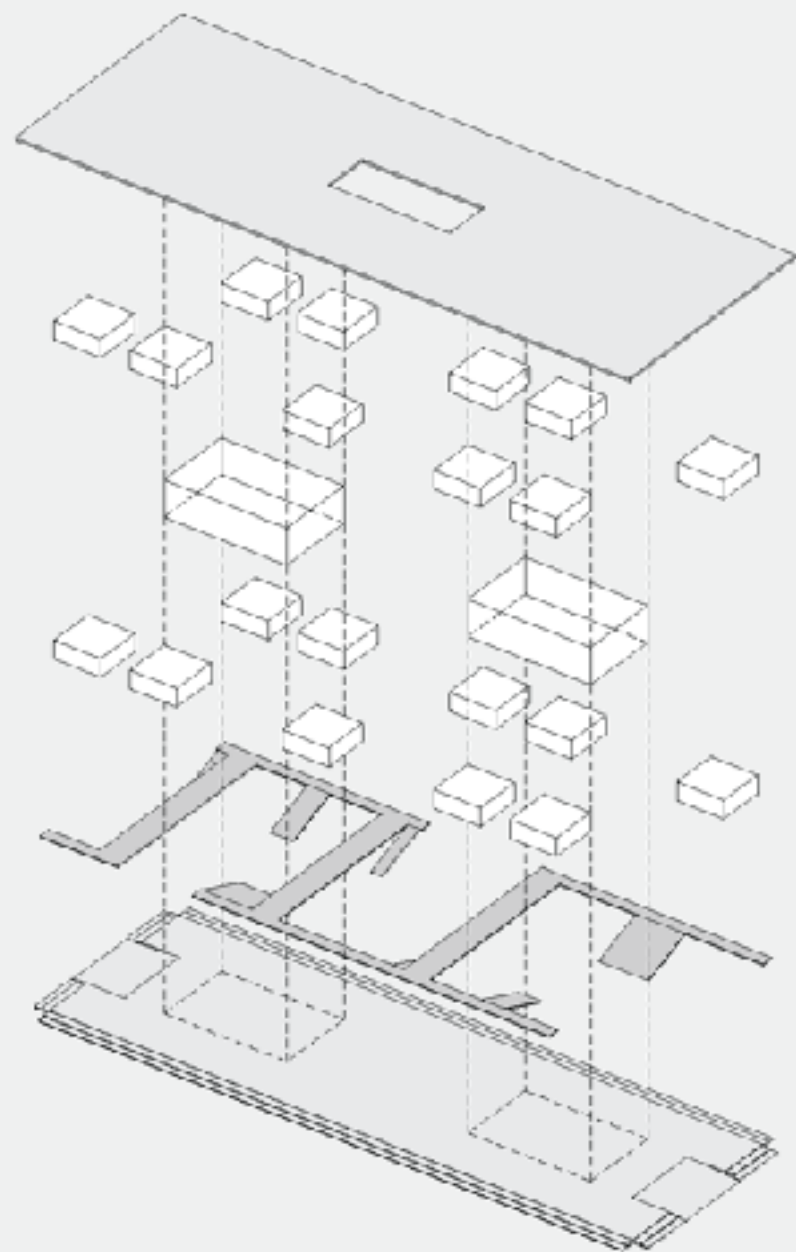

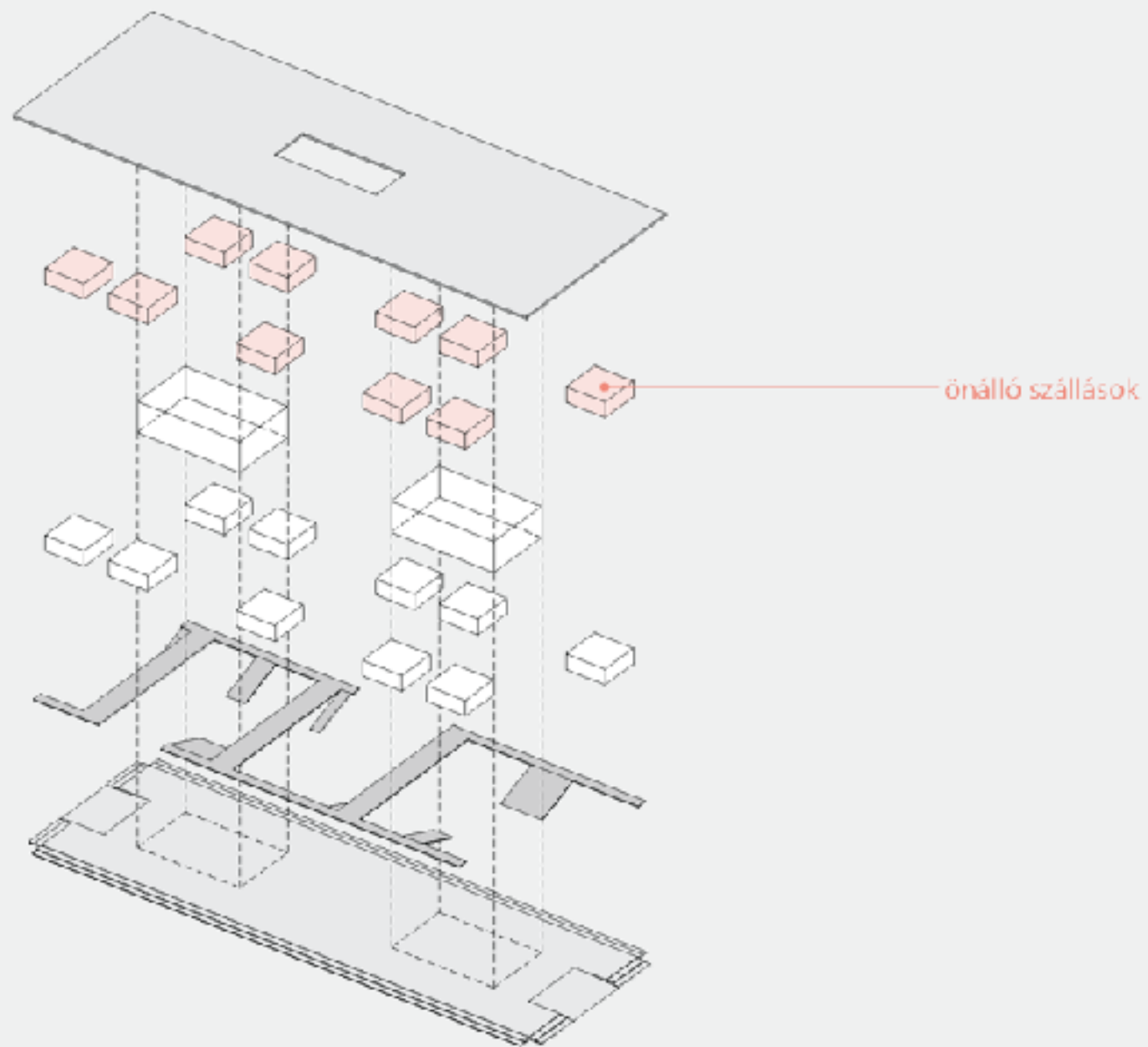

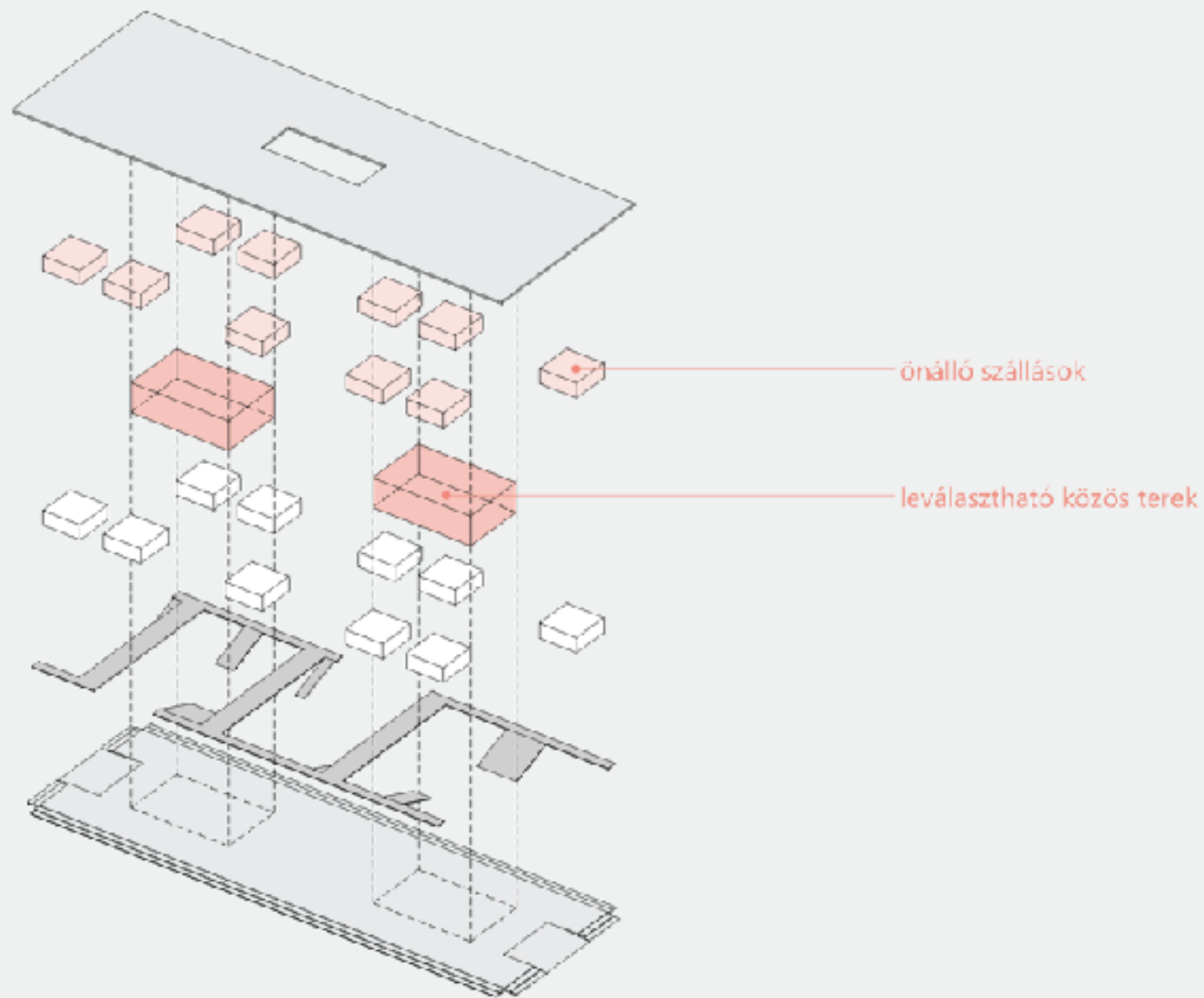

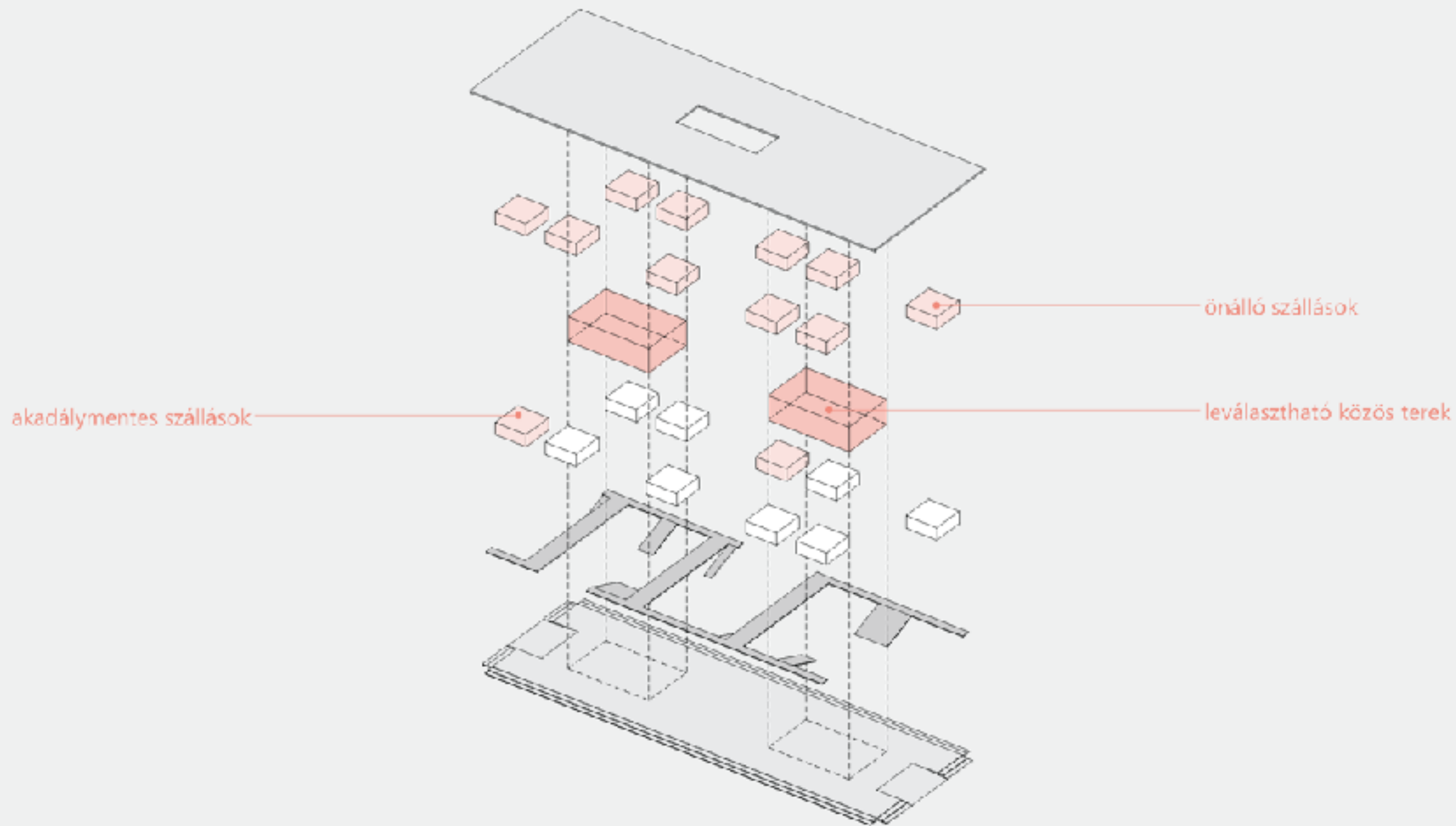

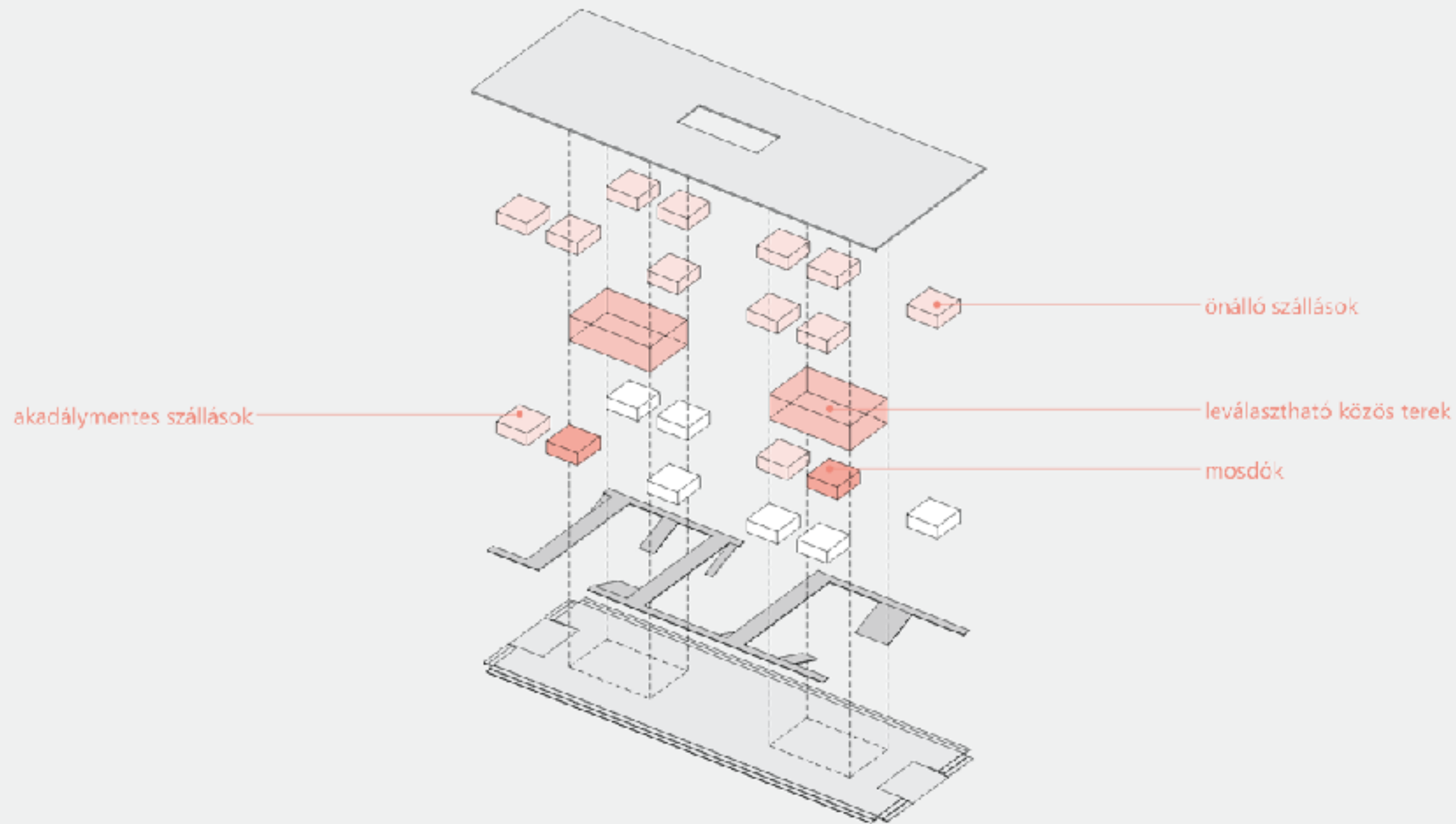

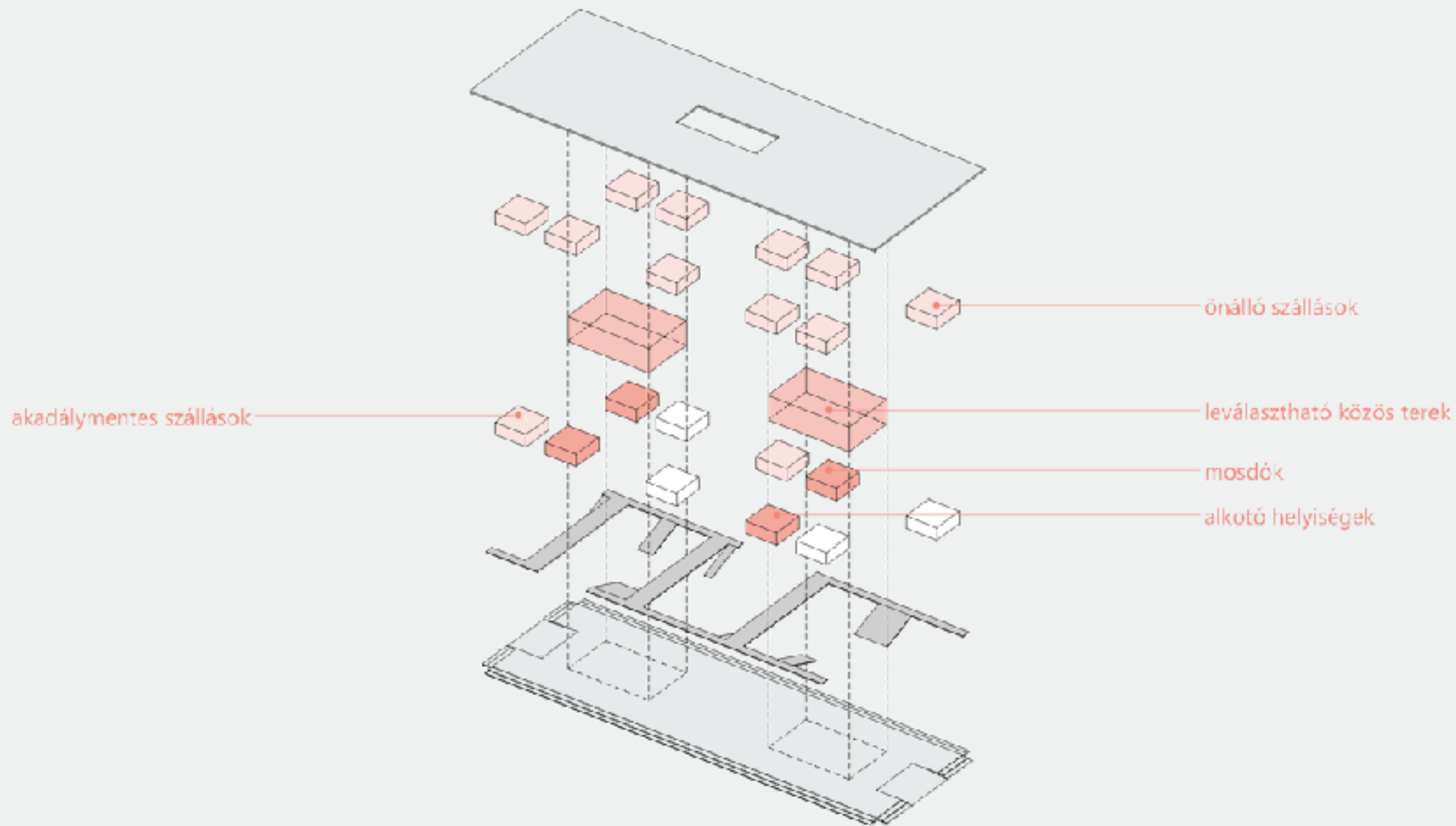

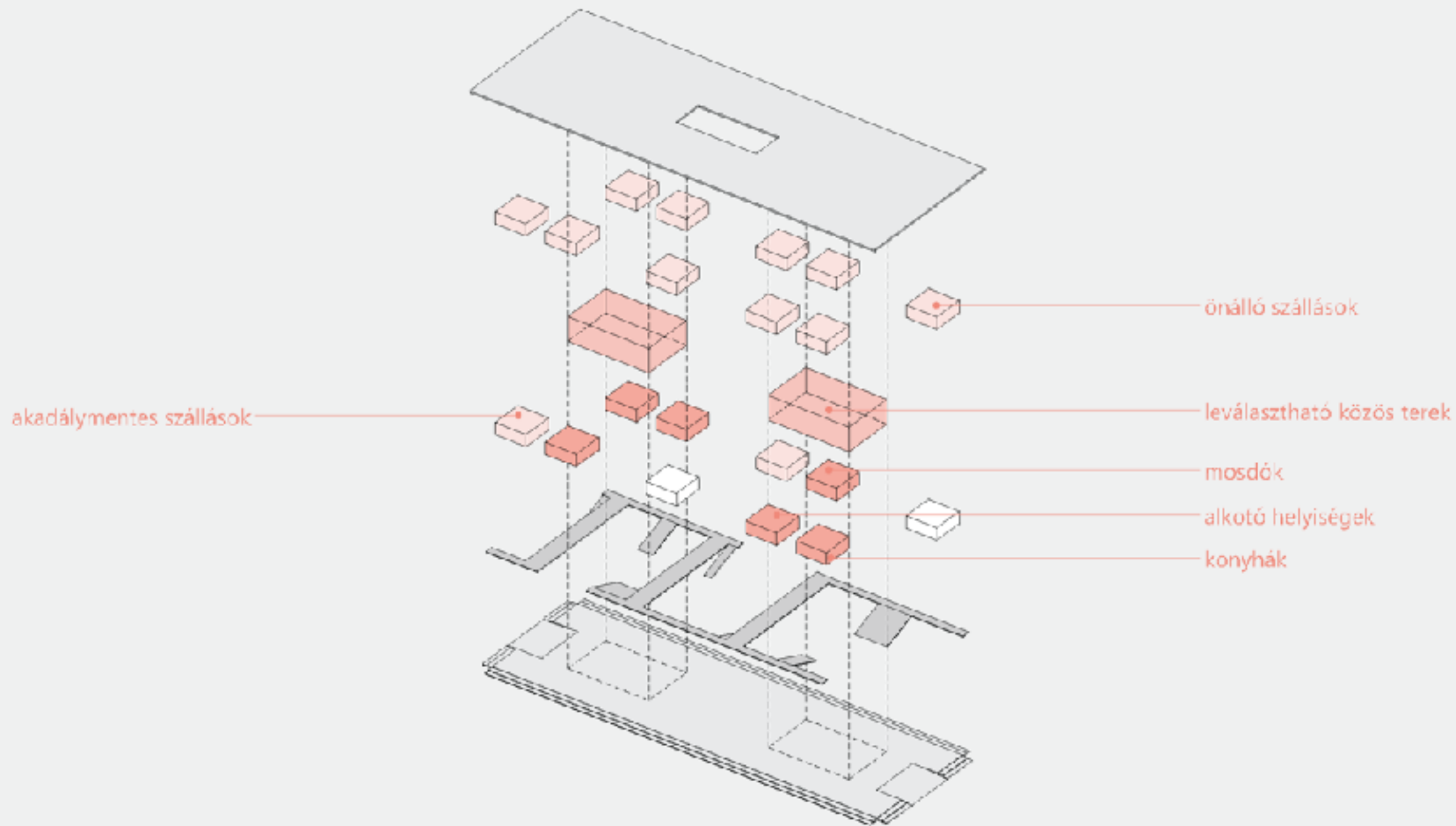

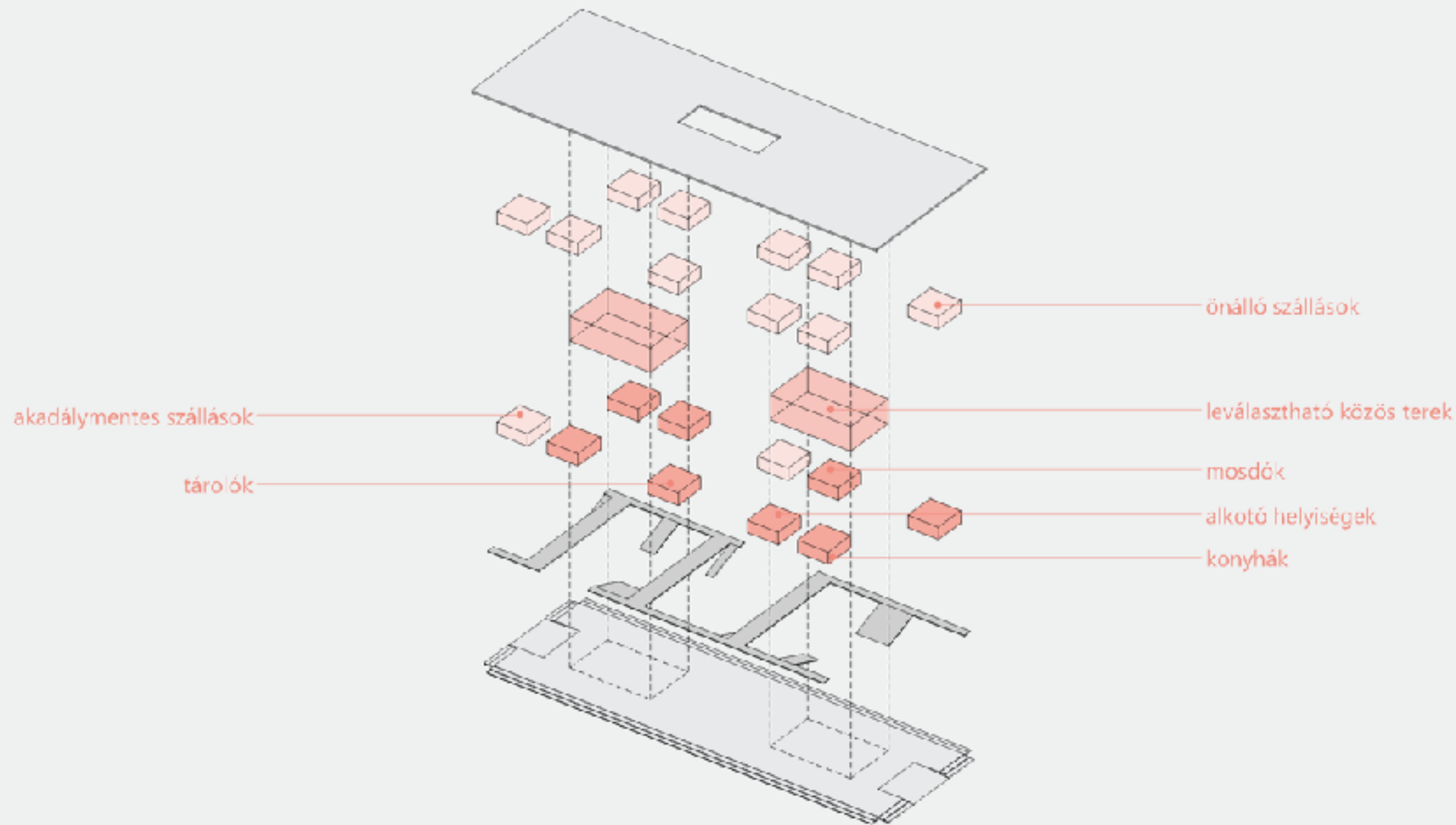



LÁTVÁNY A SZÁLLÁS KÖRNYEZETÉBŐL

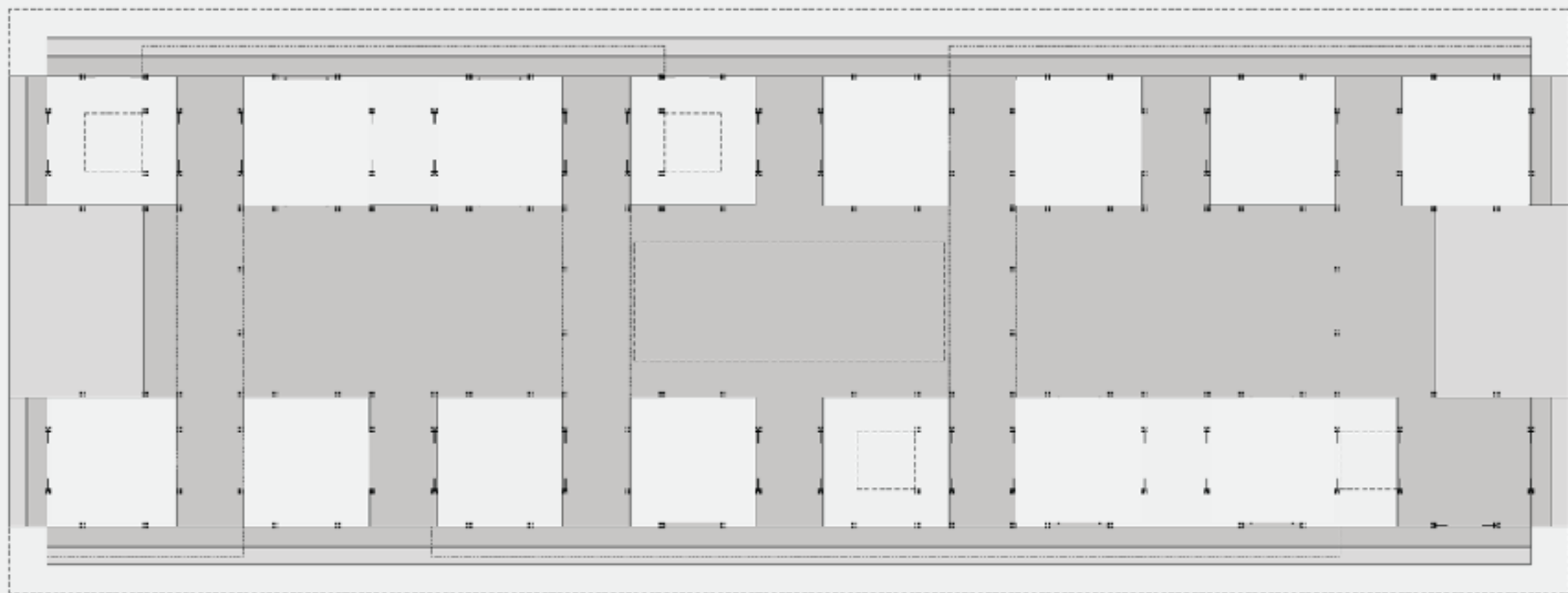

leválasztható közös, oktatási terek

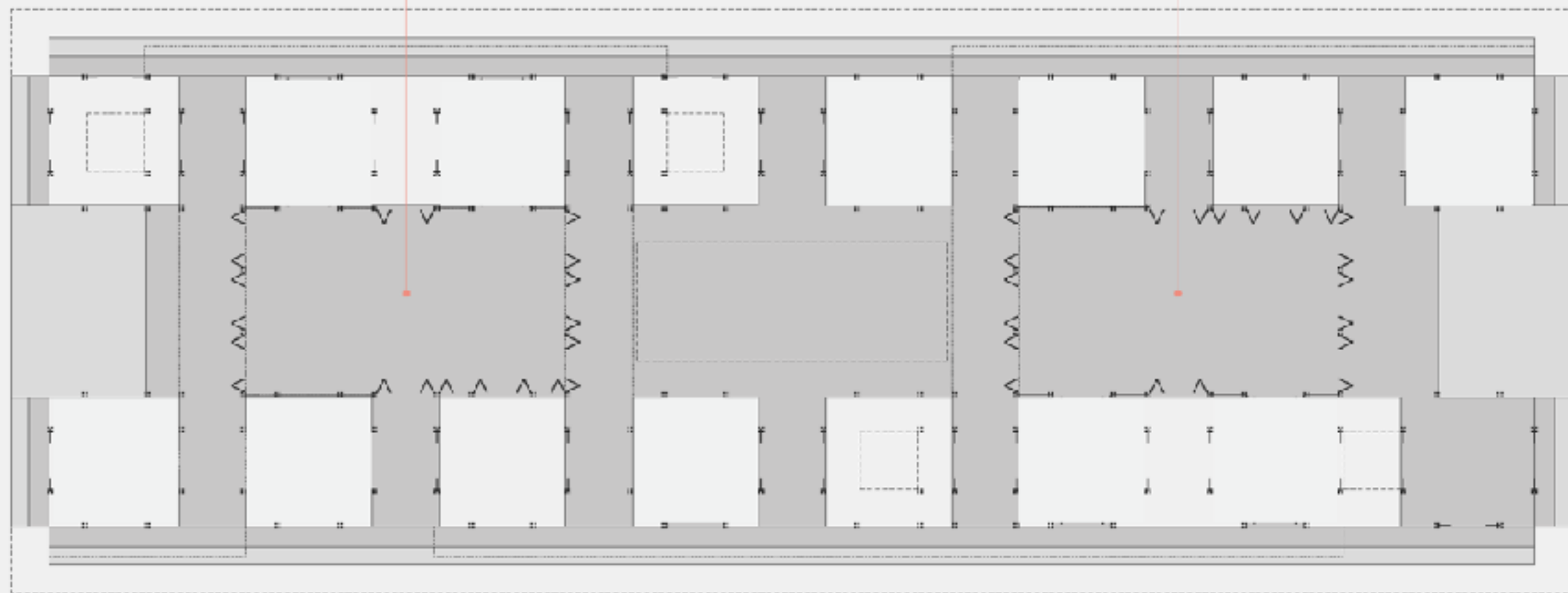

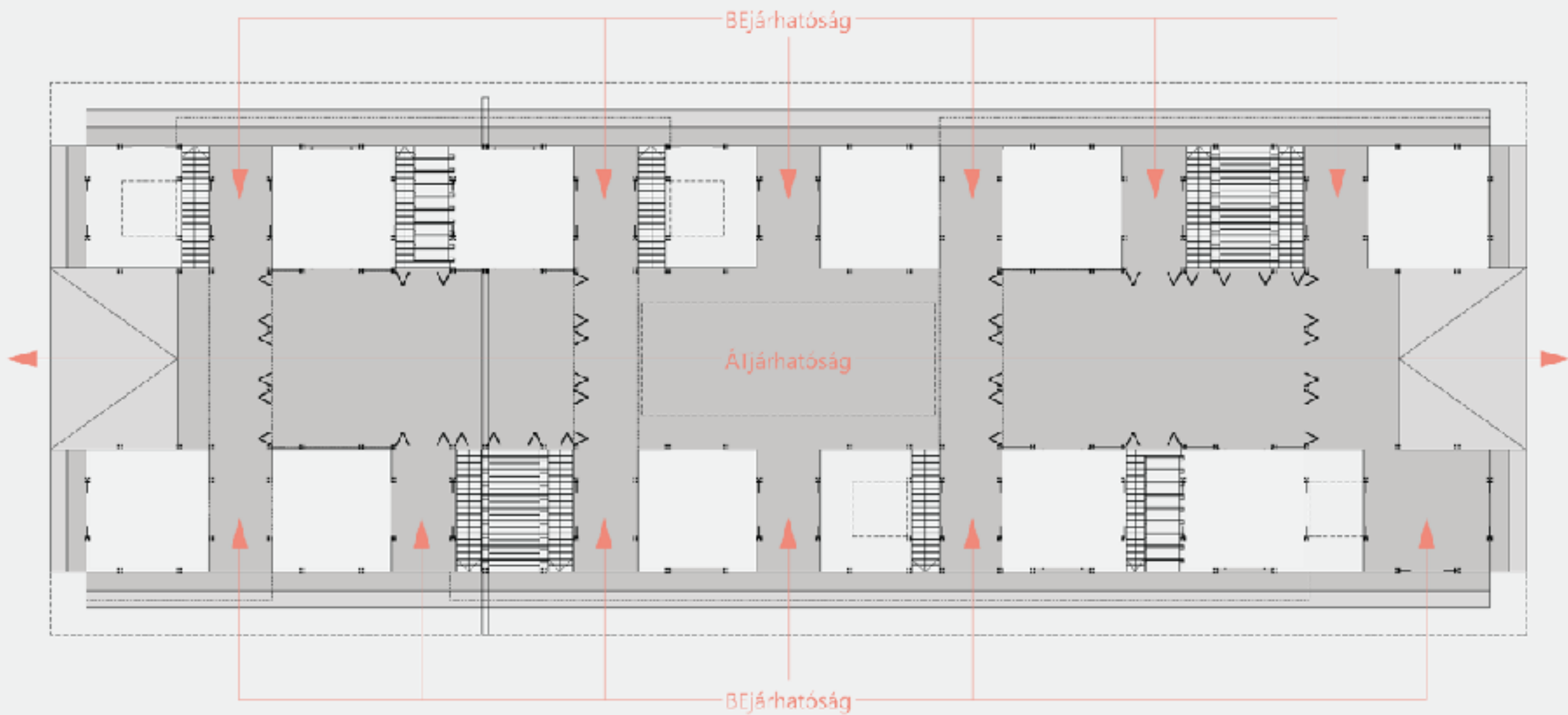

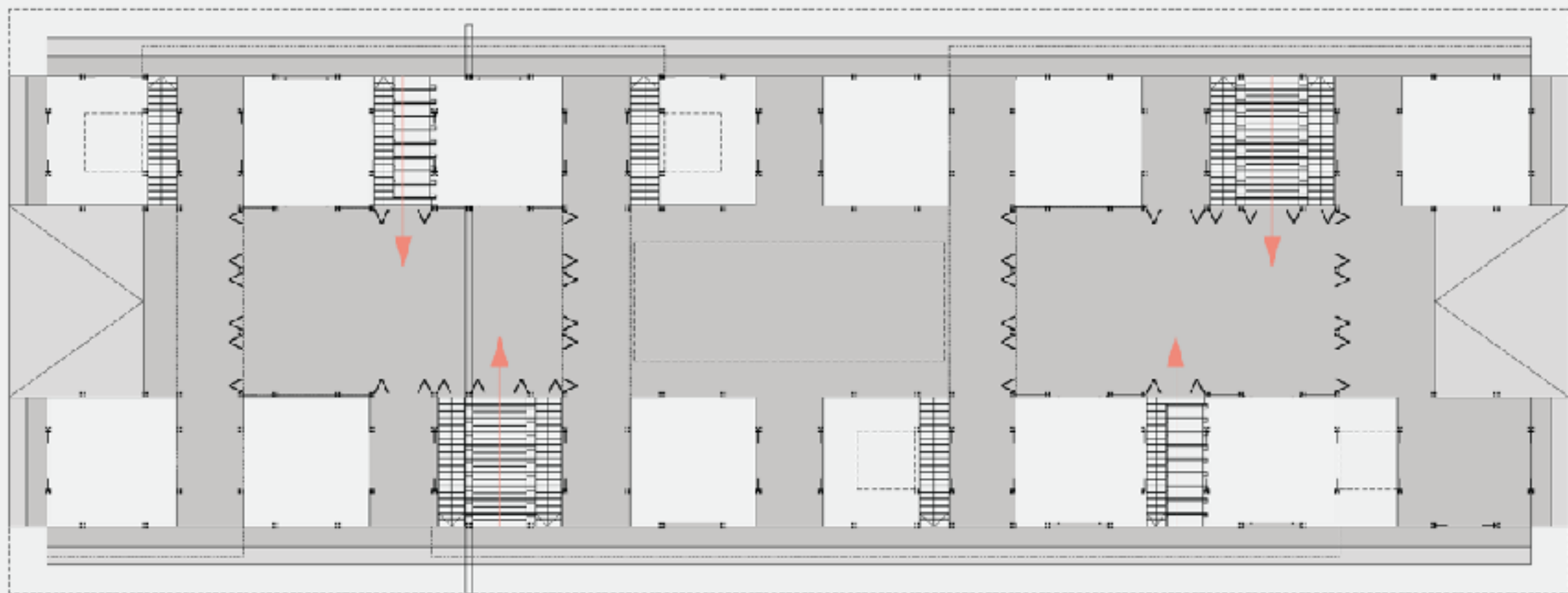

TEREPSZINTI ALAPRAJZ

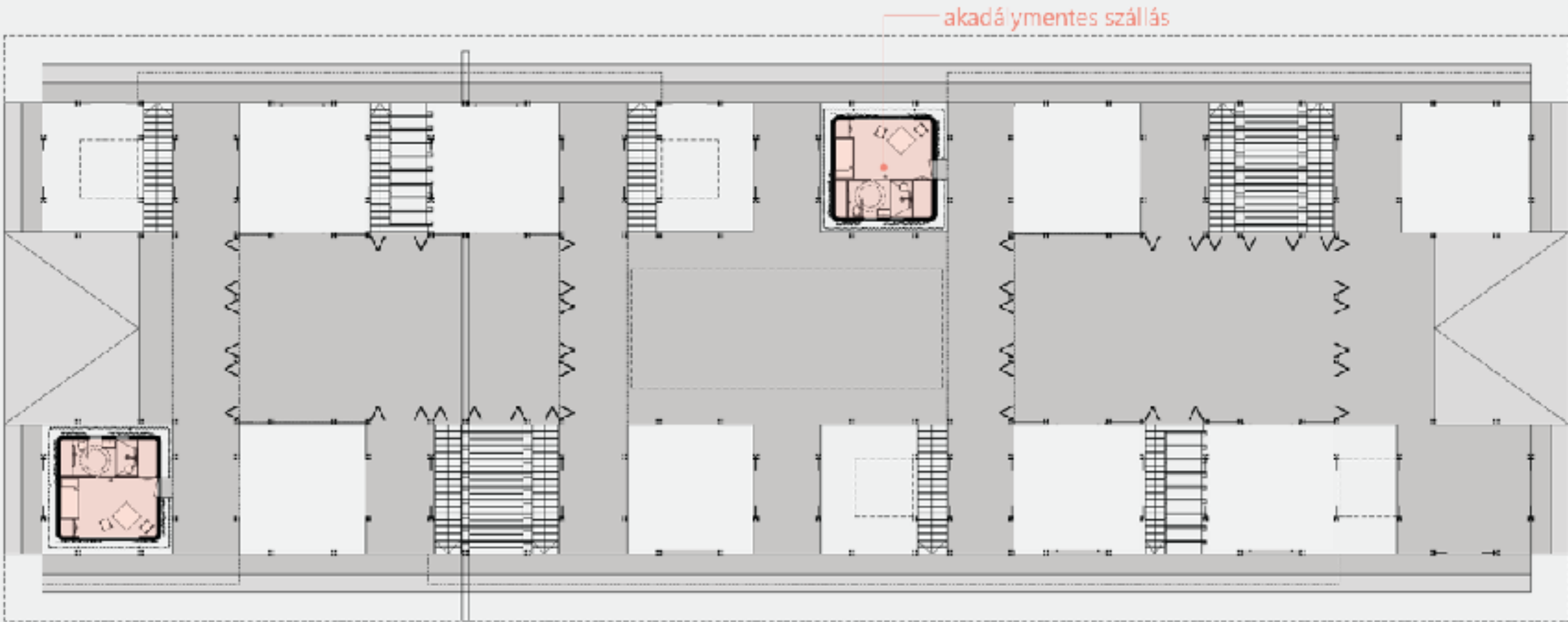

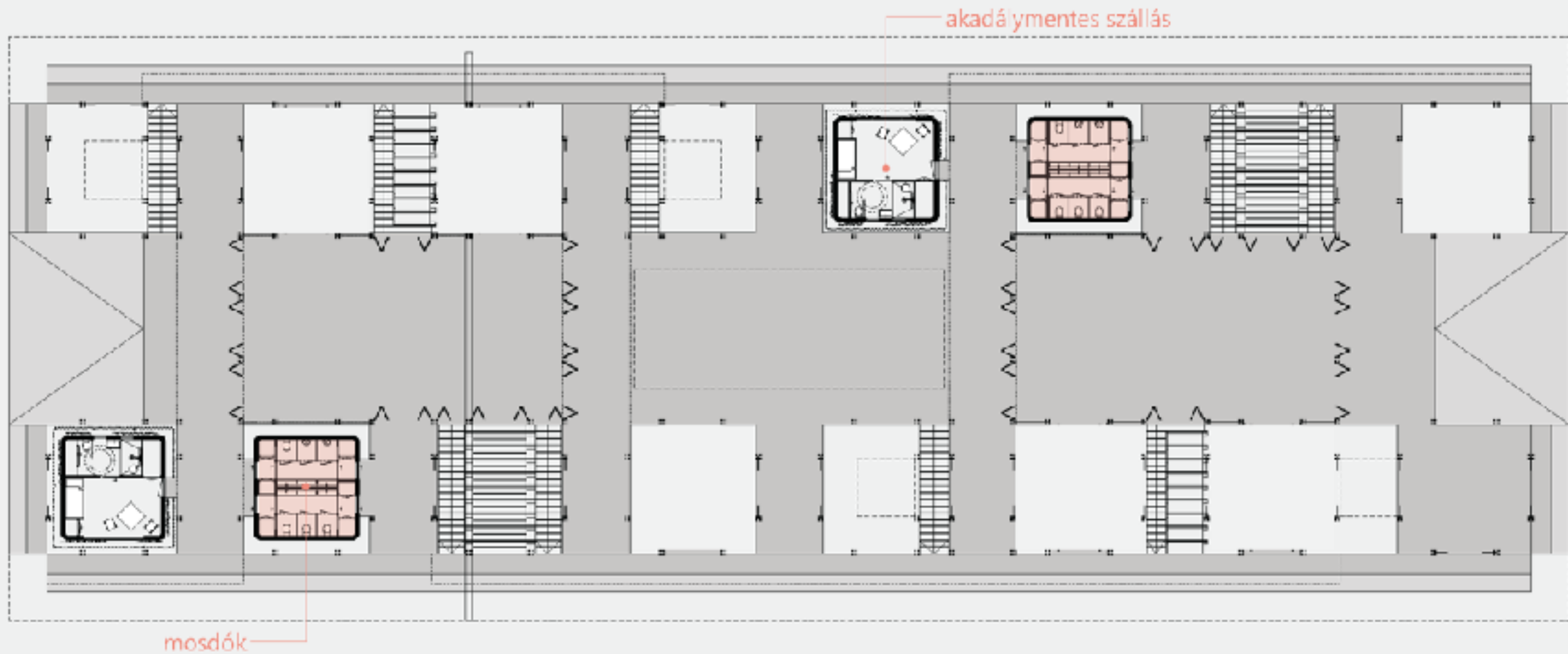

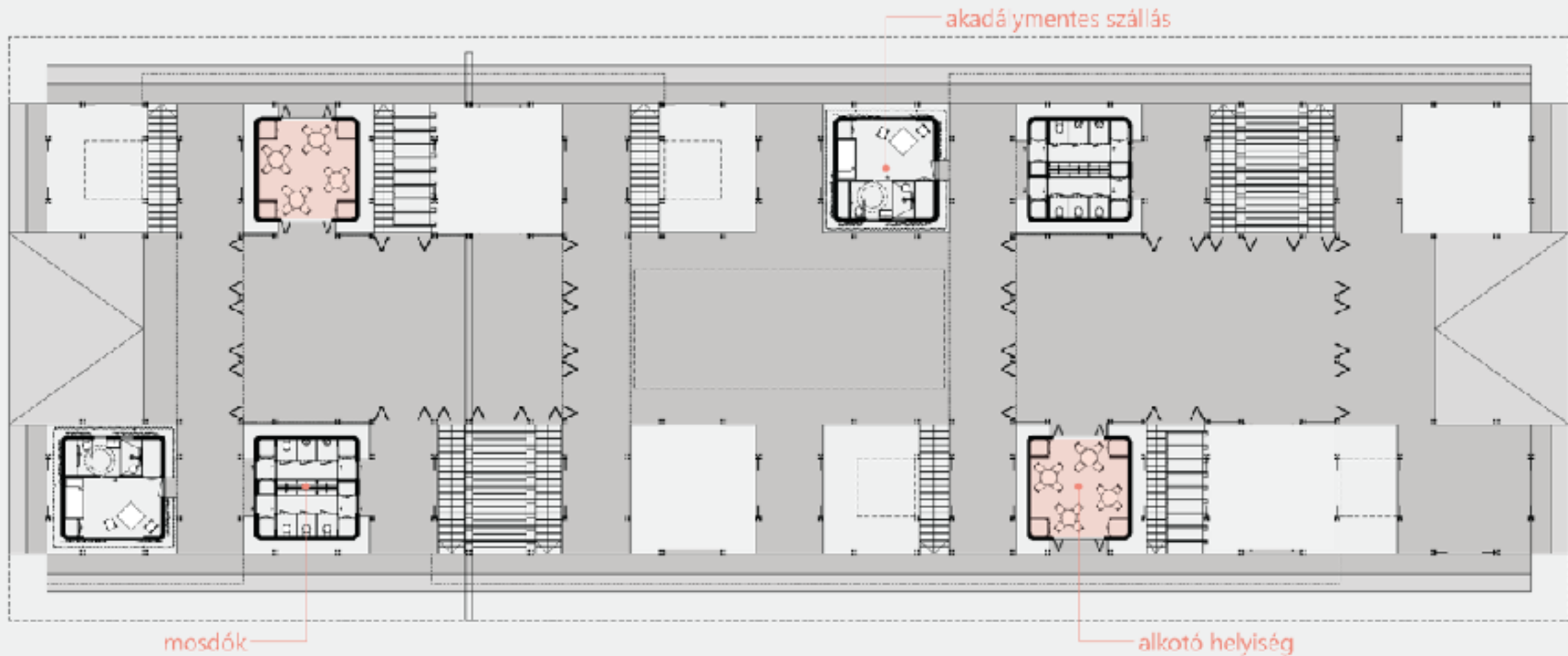

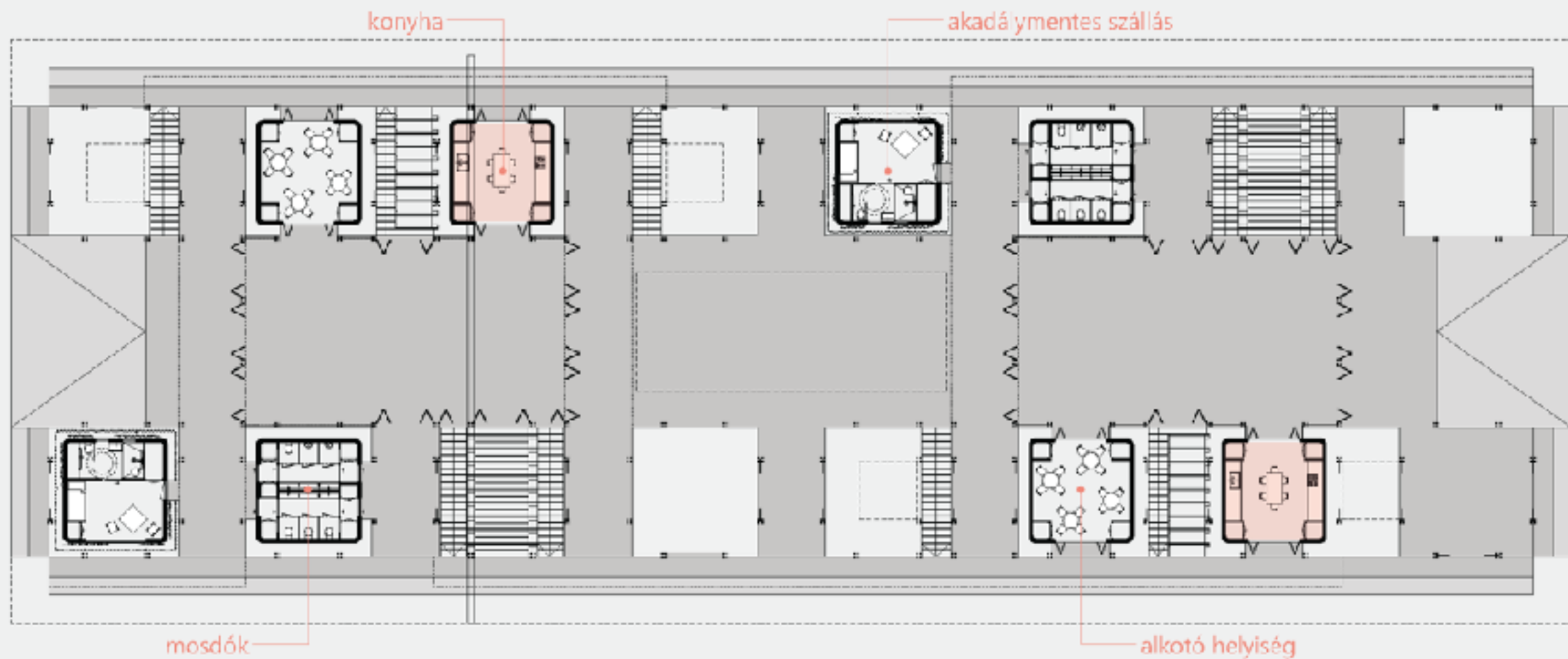

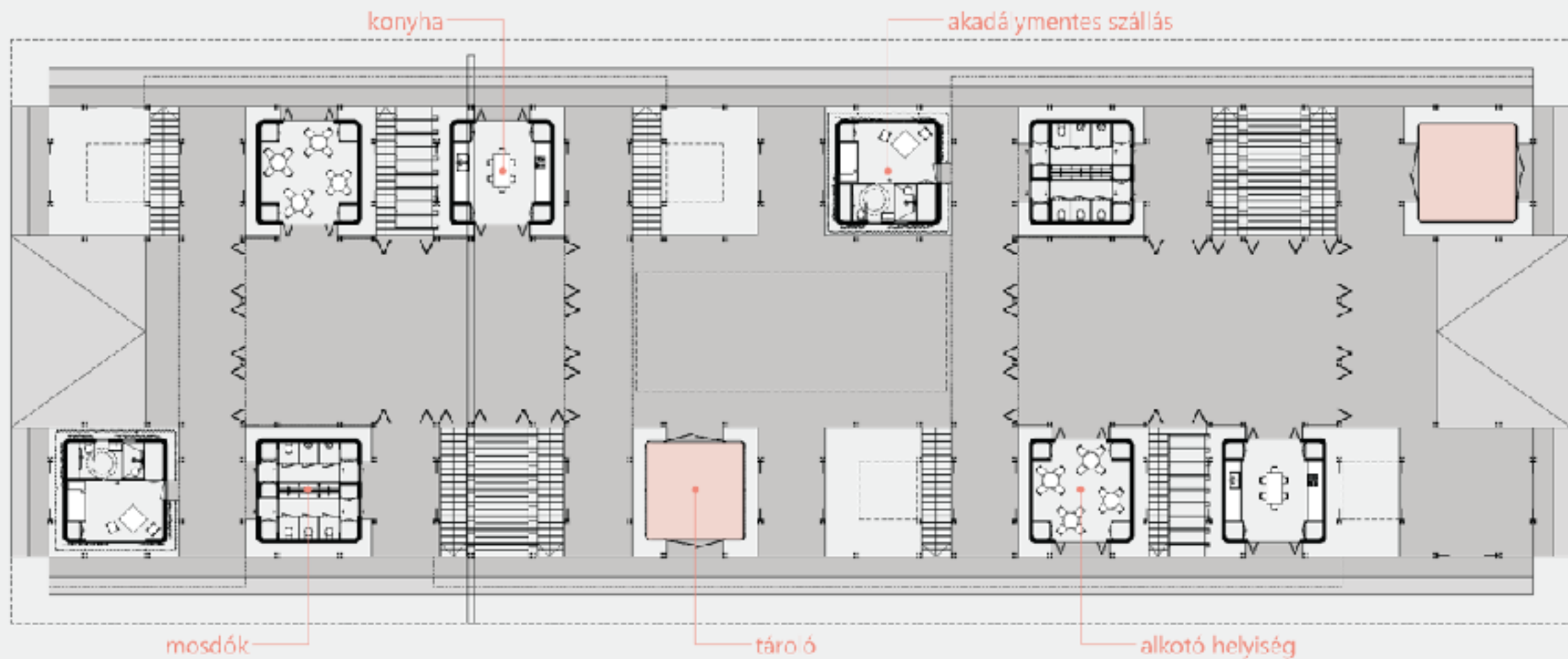

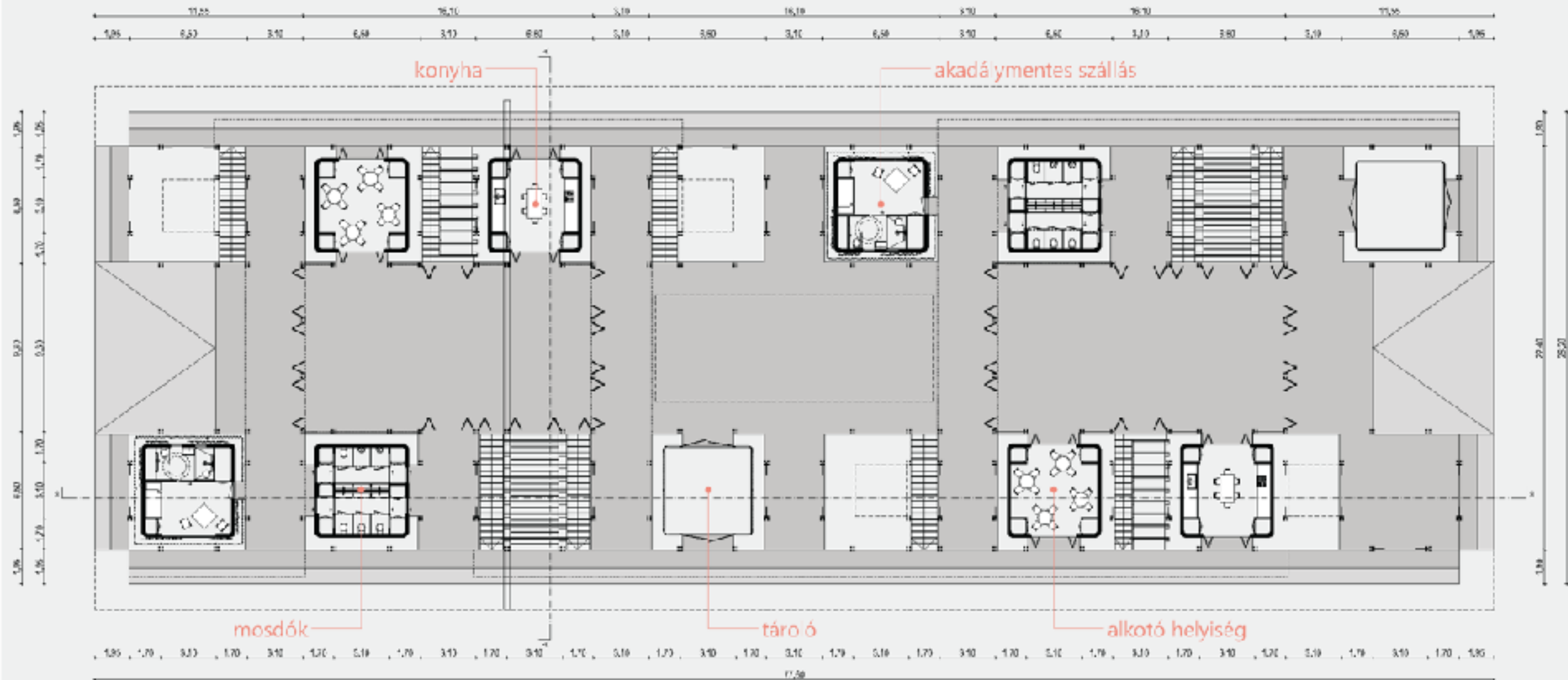

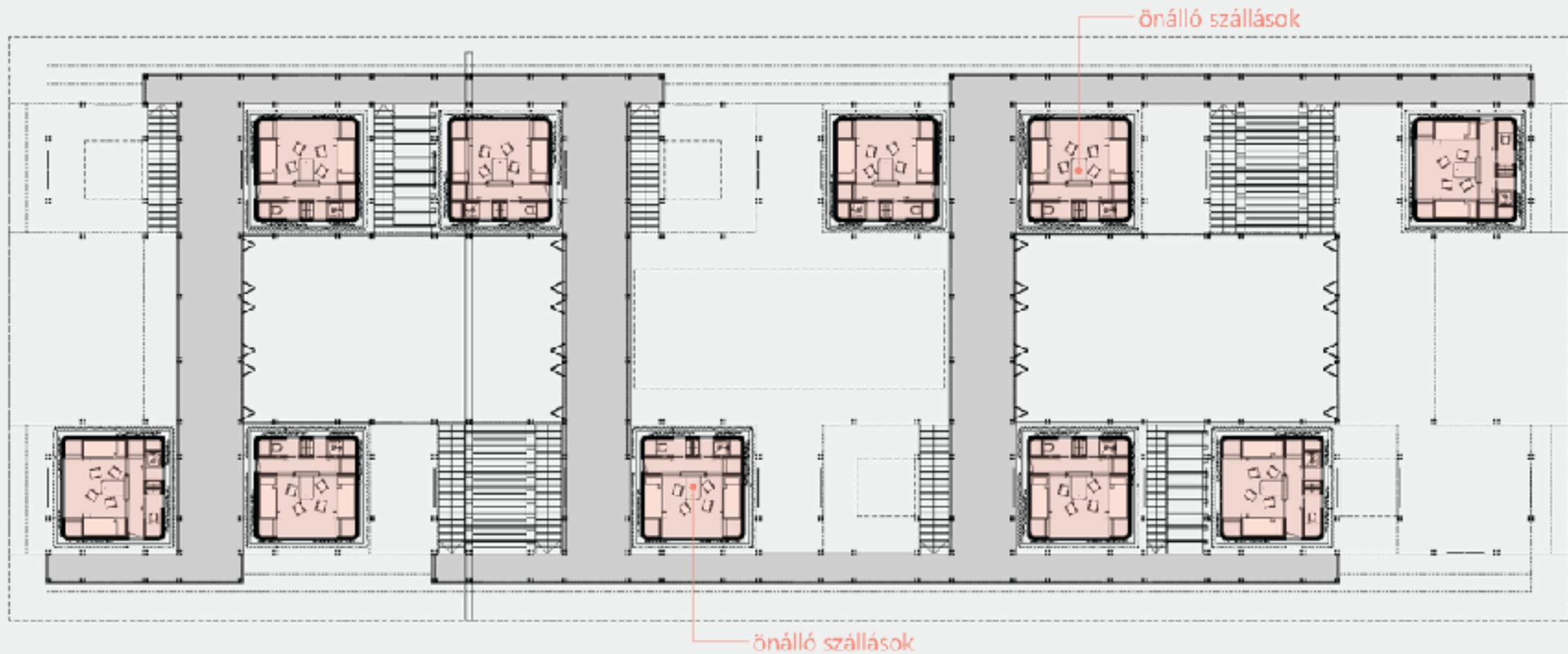

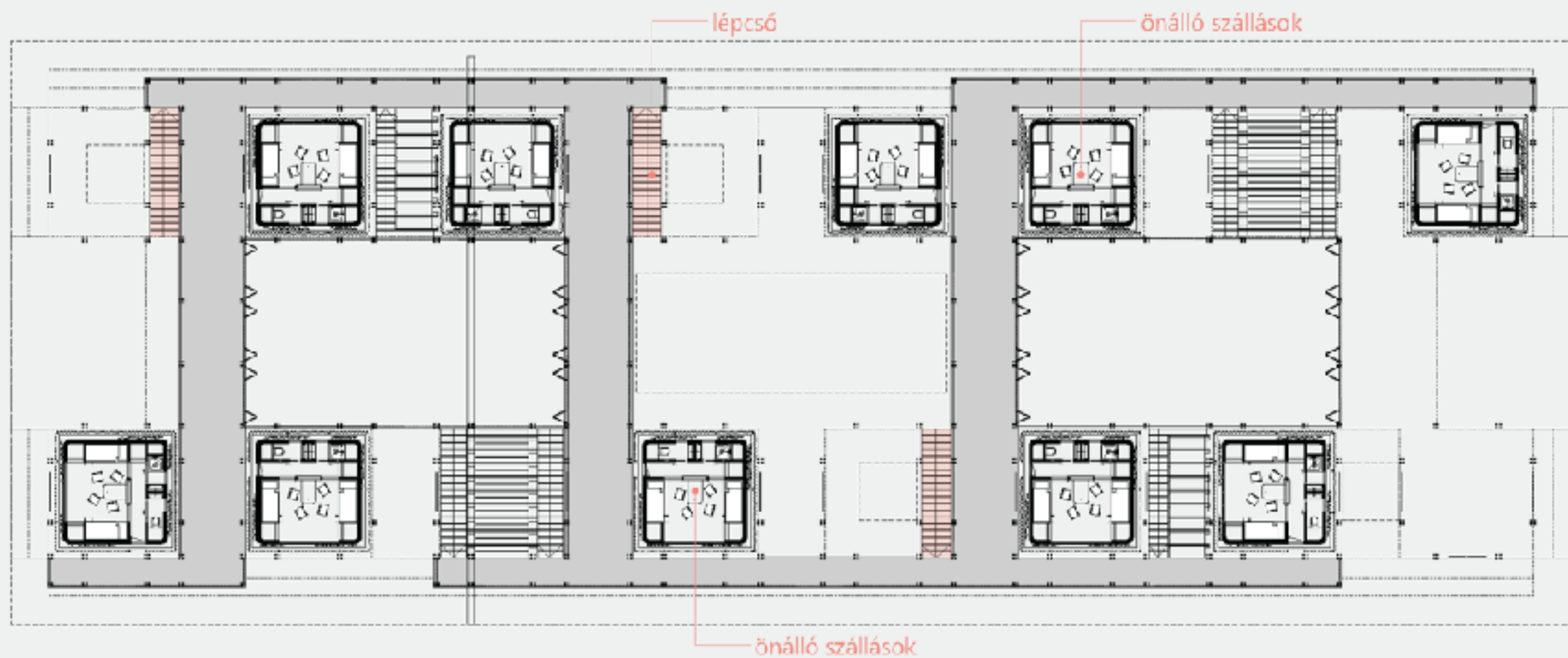

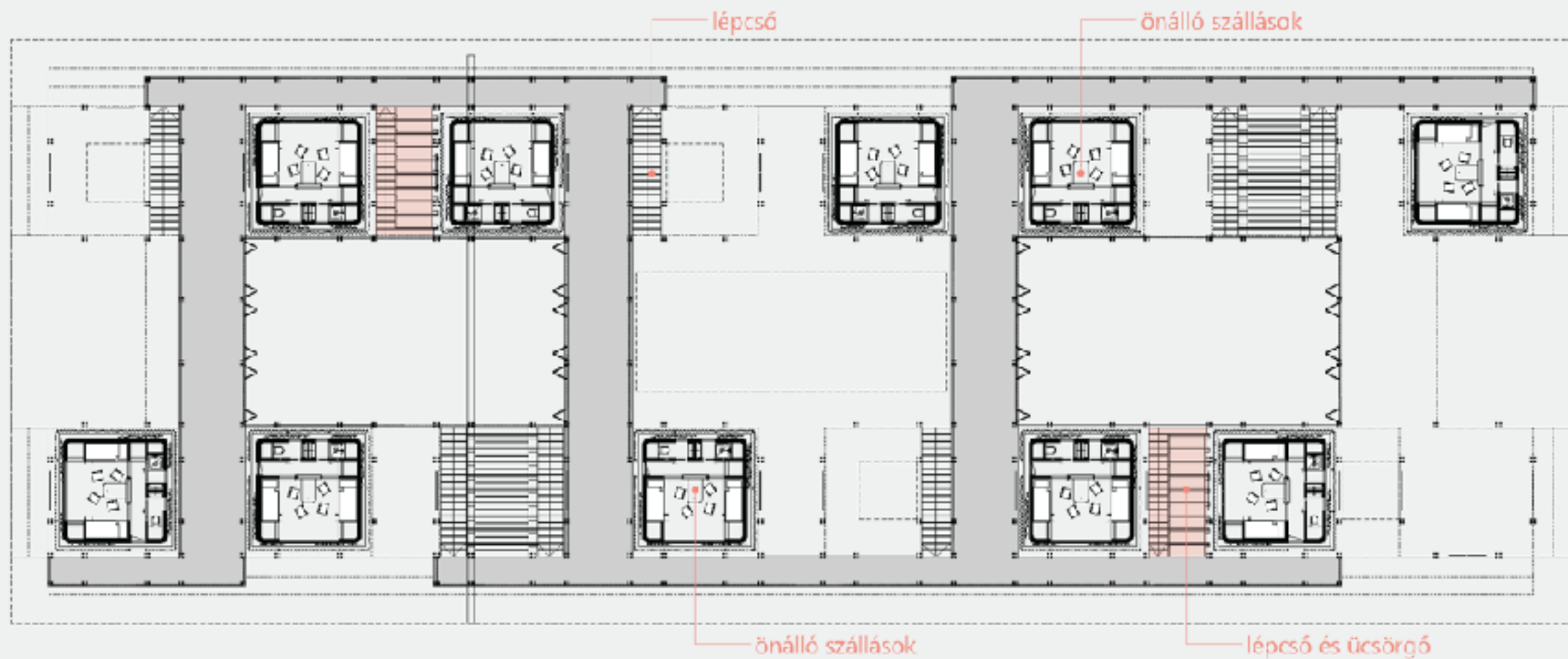

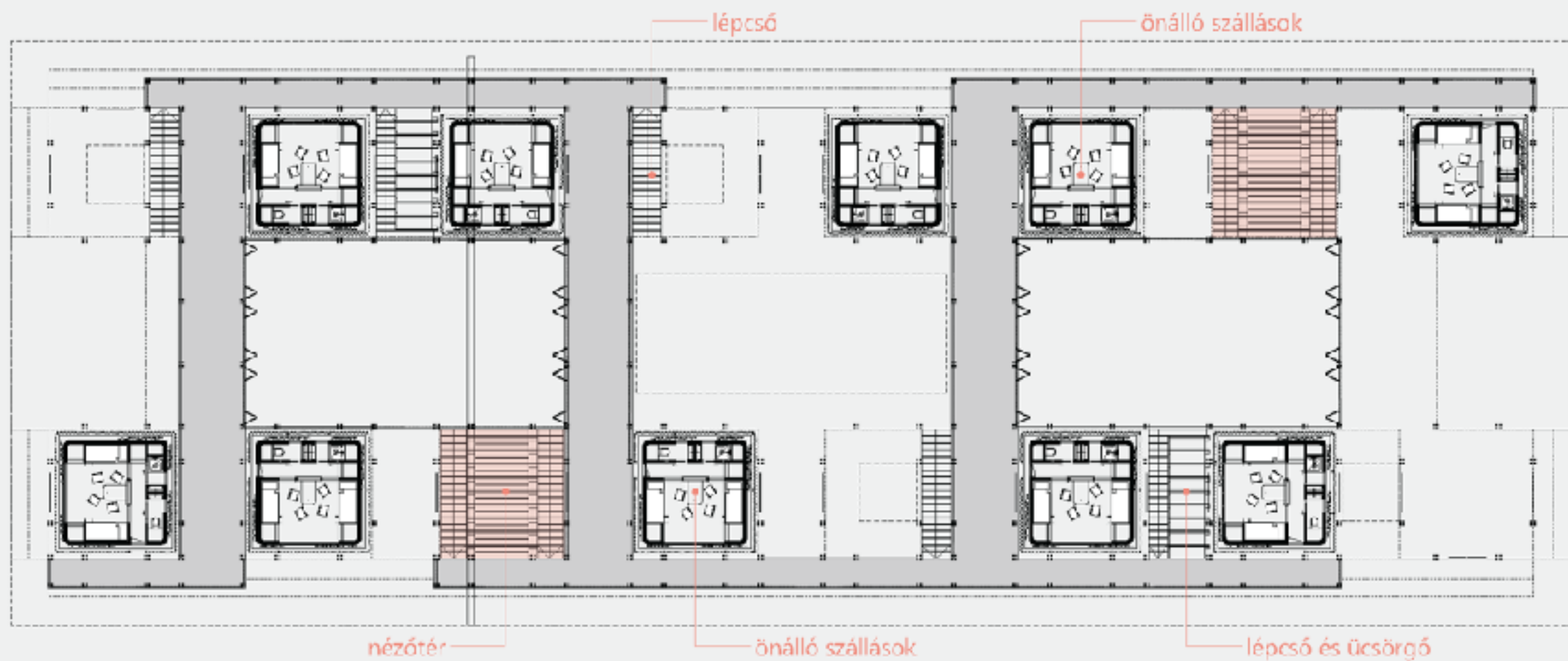

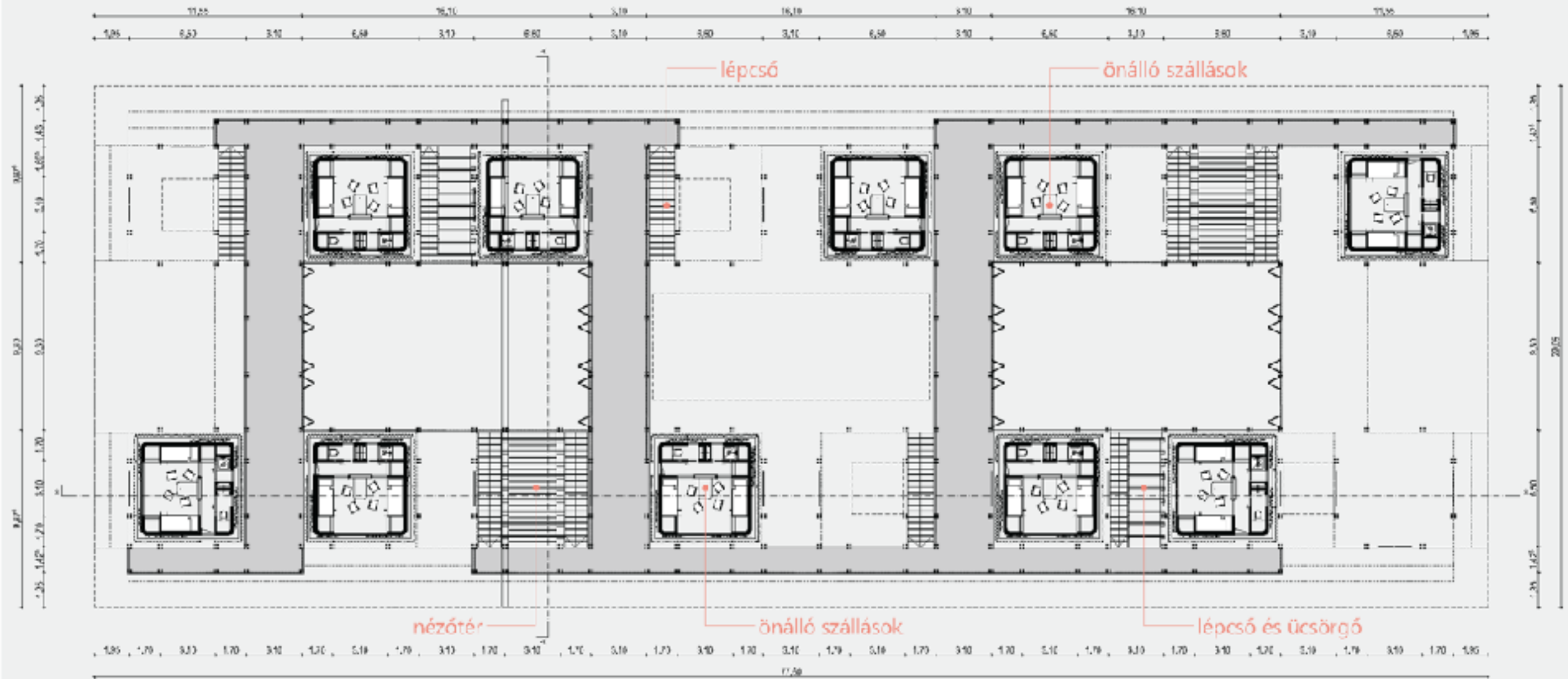

LOMBSZINTI ALAPRAJZ



LÁTVÁNY A BELSŐ KÖZÖS TEREBEN

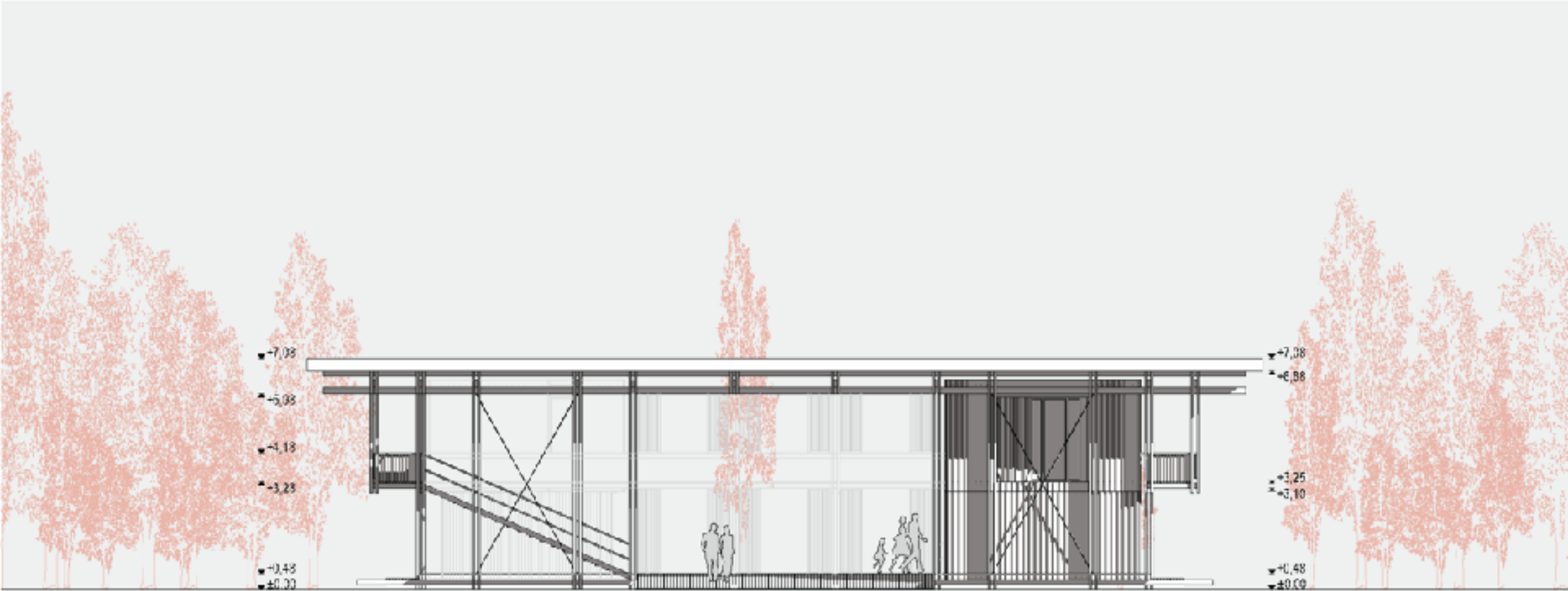



DÉLI HOMLOKZAT



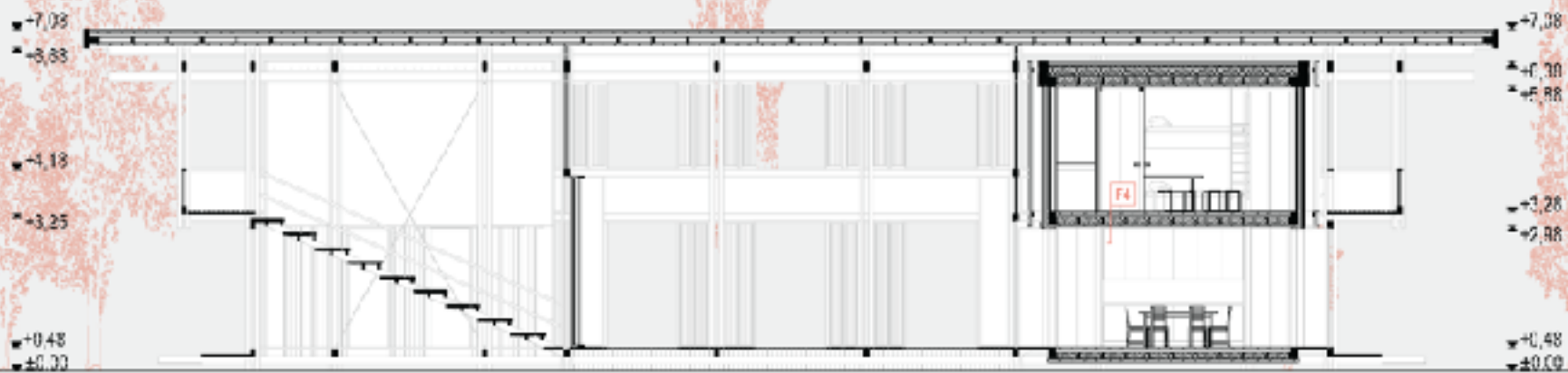

- F1** Falrész, rész. vízszintes felület
- 15 cm - cementburkolat alapozása
 - 1 cm - hővezetést gátló vízszigetelő réteg
 - 15 cm - tűzálló, impregnált gipszkarton lemez
 - 25 cm - OSB lemez
 - 1 cm - páncéltábla
 - 125 cm - fa vázszerkezet, ásványgyapot hőszigetelés kőbázzsal
 - 25 cm - impregnált OSB lemez
 - 2 cm - hőszigetelő fólia
 - 20 cm - légszigetelő szalag
 - 3 cm - polikarbonát hővezetési burkolat, fa tárcsaszalaggal

- F2** Falrész, rész. vízszintes felület, szellő
- 3 cm - festett fa falburkolat, akasztva
 - 2,5 cm - OSB lemez
 - 1 cm - páncéltábla
 - 12,5 cm - fa vázszerkezet, ásványgyapot hőszigetelés kőbázzsal
 - 2,5 cm - impregnált OSB lemez
 - 2 cm - hőszigetelő fólia
 - 30 cm - légszigetelő szalag
 - 3 cm - polikarbonát hővezetési burkolat, fa tárcsaszalaggal

- F3** Falrész, rész. vízszintes felület, szellő
- 3 cm - festett fa falburkolat, akasztva
 - 2,5 cm - OSB lemez
 - 12,5 cm - fa vázszerkezet, ásványgyapot hőszigetelés kőbázzsal
 - 2,5 cm - OSB lemez
 - 2 cm - hőszigetelő fólia
 - 3 cm - függőleges fa lécburkolat

- F4** Földszint, rész. vízszintes felület, szellő
- 2,5 cm - fa padlóburkolat
 - 2,5 cm - gipszlemez
 - 2 cm - légszigetelő szalag
 - 2,5 cm - OSB lemez
 - 20 cm - fa vázszerkezet, ásványgyapot hőszigetelés kőbázzsal
 - 2,5 cm - mennyezeti fólia
 - 1,5 cm - gipszkarton burkolat
 - 1 cm - glettelés, ásvány

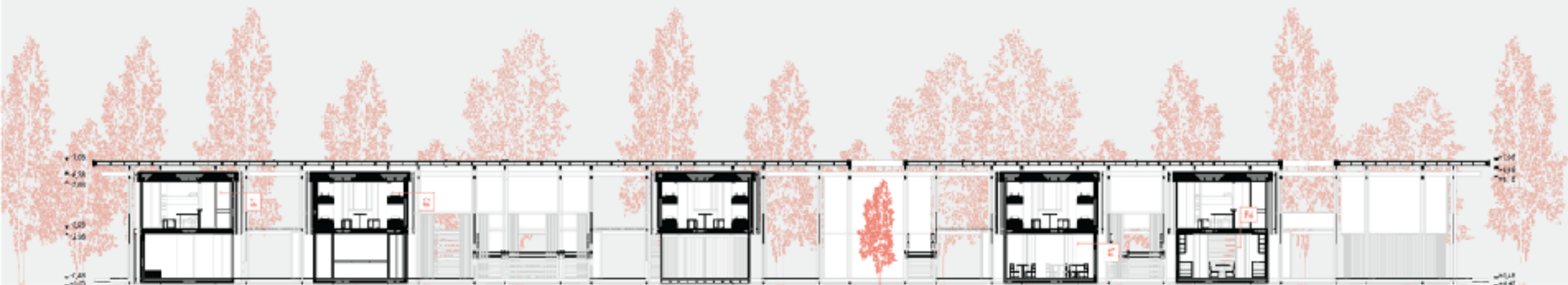

- F1** Falrész, rész. vízszintes felület
- 1,5 cm - omlóbetűburkolat rögzítése
 - 1 cm - hőszigetelőréteg, vízgátoló réteg
 - 1,5 cm - ágyasztó, impregnált gipszkarton lemez
 - 2,5 cm - OSB lemez
 - 1 cm - pórási fólia
 - 12,5 cm - fa vázszerkezet, ásványgyapot hőszigetelés, kőbázeis
 - 2,5 cm - impregnált OSB lemez
 - 2 cm - hőszigetelő fólia
 - 20 cm - légszigetelő, mozgatható függőlemez
 - 3 cm - polikarbonát hővezető burkolat, fa támasztóelem

- F2** Falrész, rész. vízszintes felület, szellő
- 3 cm - festett fa falburkolat, akasztva
 - 2,5 cm - OSB lemez
 - 1 cm - pórási fólia
 - 12,5 cm - fa vázszerkezet, ásványgyapot hőszigetelés, kőbázeis
 - 2,5 cm - ágyasztó OSB lemez
 - 2 cm - hőszigetelő fólia
 - 30 cm - légszigetelő, mozgatható függőlemez
 - 3 cm - polikarbonát hővezető burkolat, fa támasztóelem

- F3** Falrész, rész. vízszintes felület, szellő
- 3 cm - festett fa falburkolat, akasztva
 - 2,5 cm - OSB lemez
 - 12,5 cm - fa vázszerkezet, ásványgyapot hőszigetelés, kőbázeis
 - 2,5 cm - OSB lemez
 - 2 cm - ásványgyapot hőszigetelő fólia
 - 3 cm - függőleges fa lécburkolat

- F4** Földszint, rész. vízszintes felület, szellő
- 2,5 cm - fa gipszburkolat
 - 2,5 cm - gipszburkolat
 - 2 cm - légszigetelő réteg
 - 2,5 cm - OSB lemez
 - 20 cm - fa vázszerkezet, ásványgyapot hőszigetelés, kőbázeis
 - 2,5 cm - mennyezeti fólia
 - 1,5 cm - gipszkarton burkolat
 - 1 cm - glettelés, ásvány



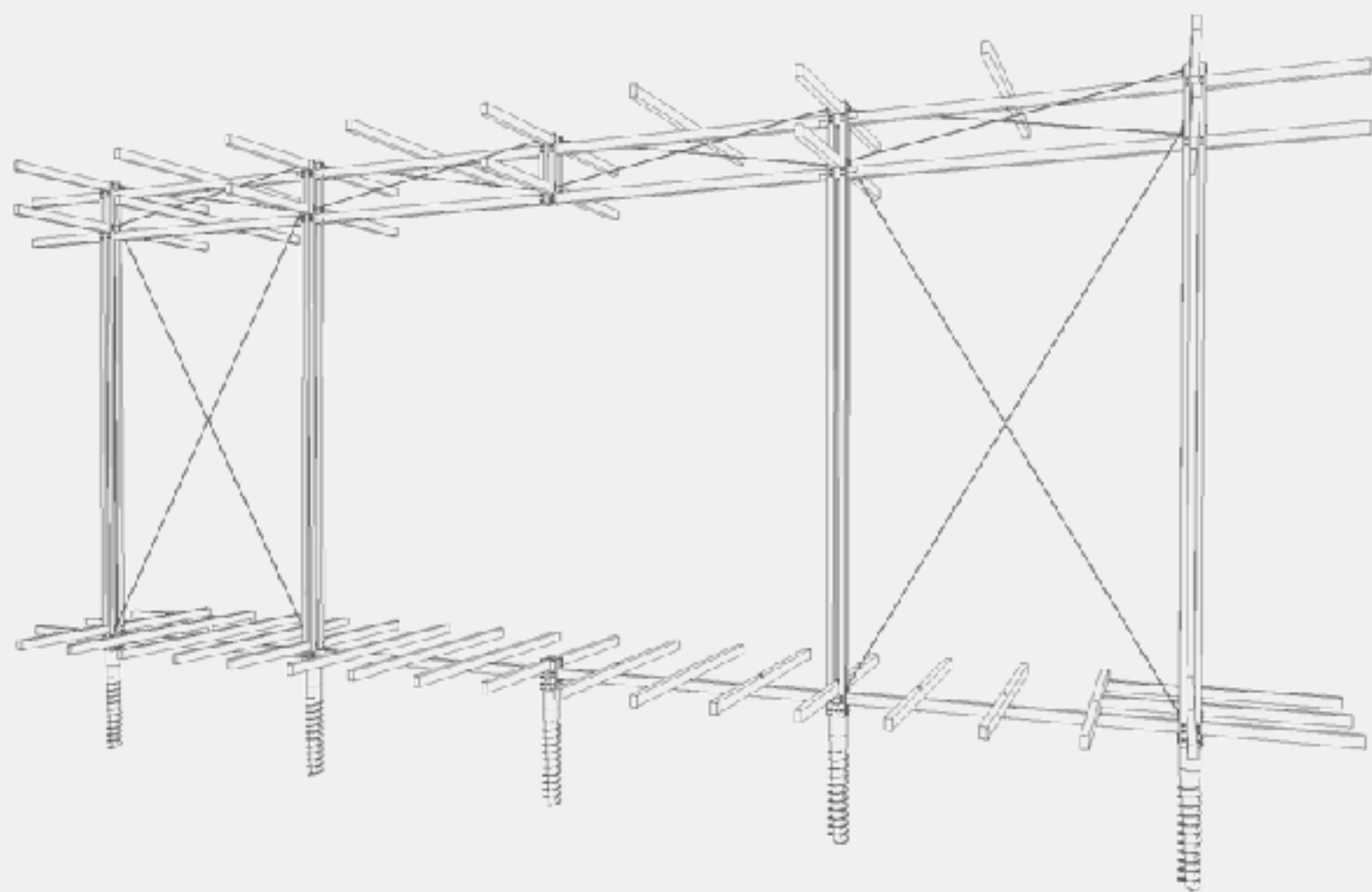
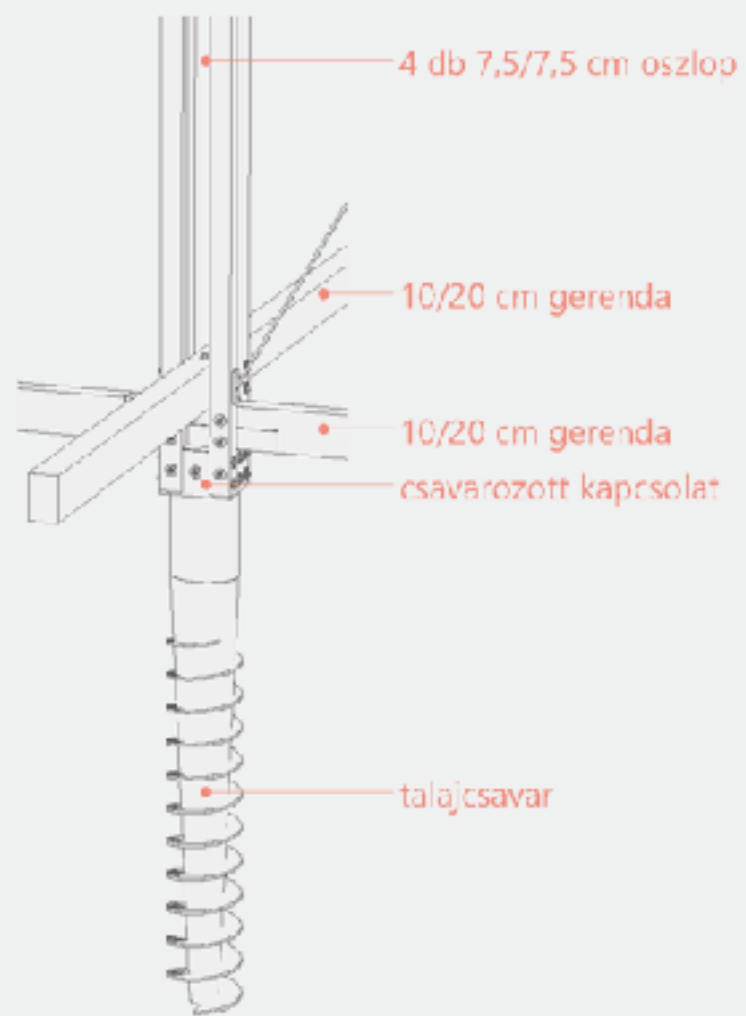

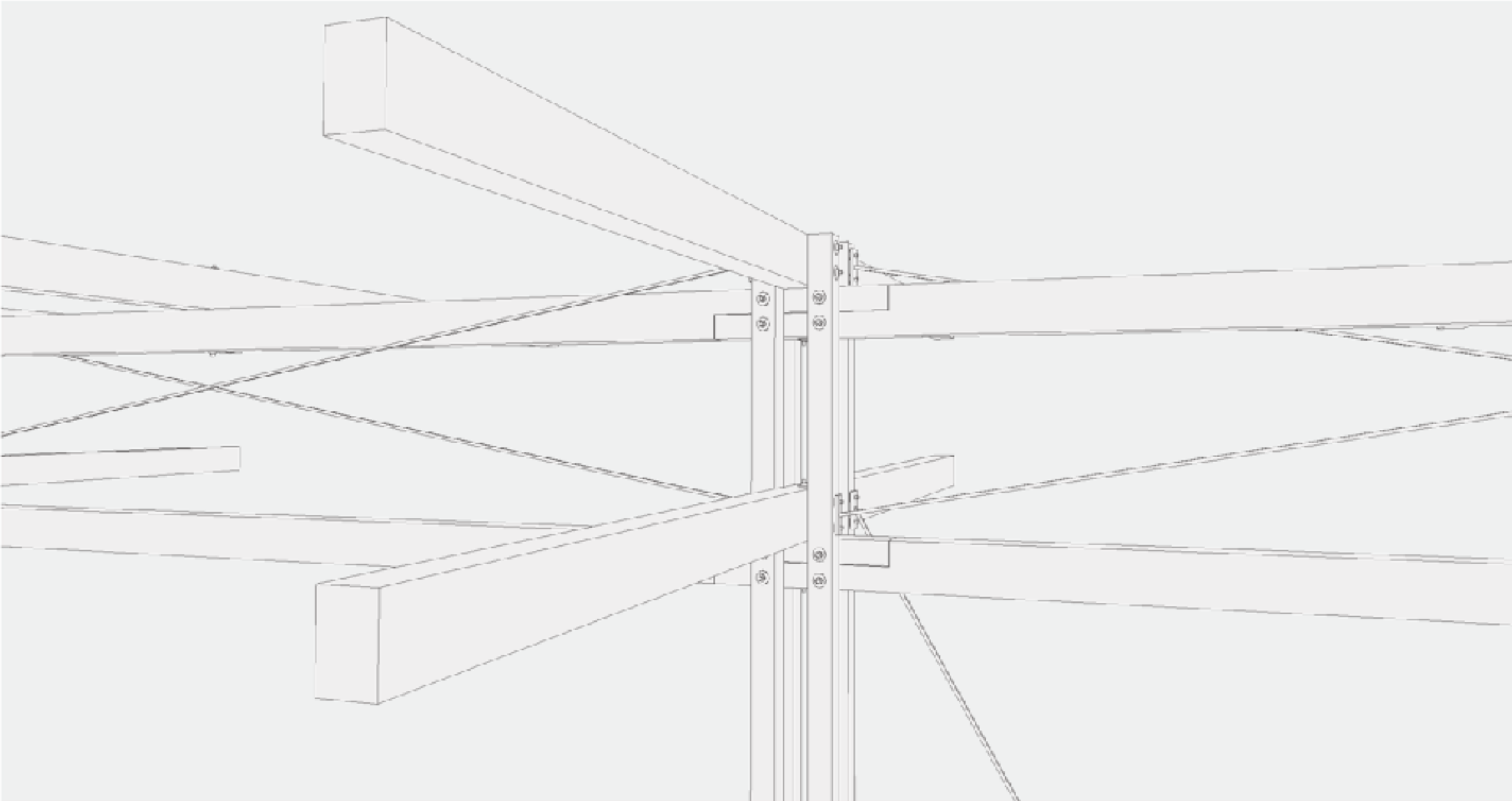



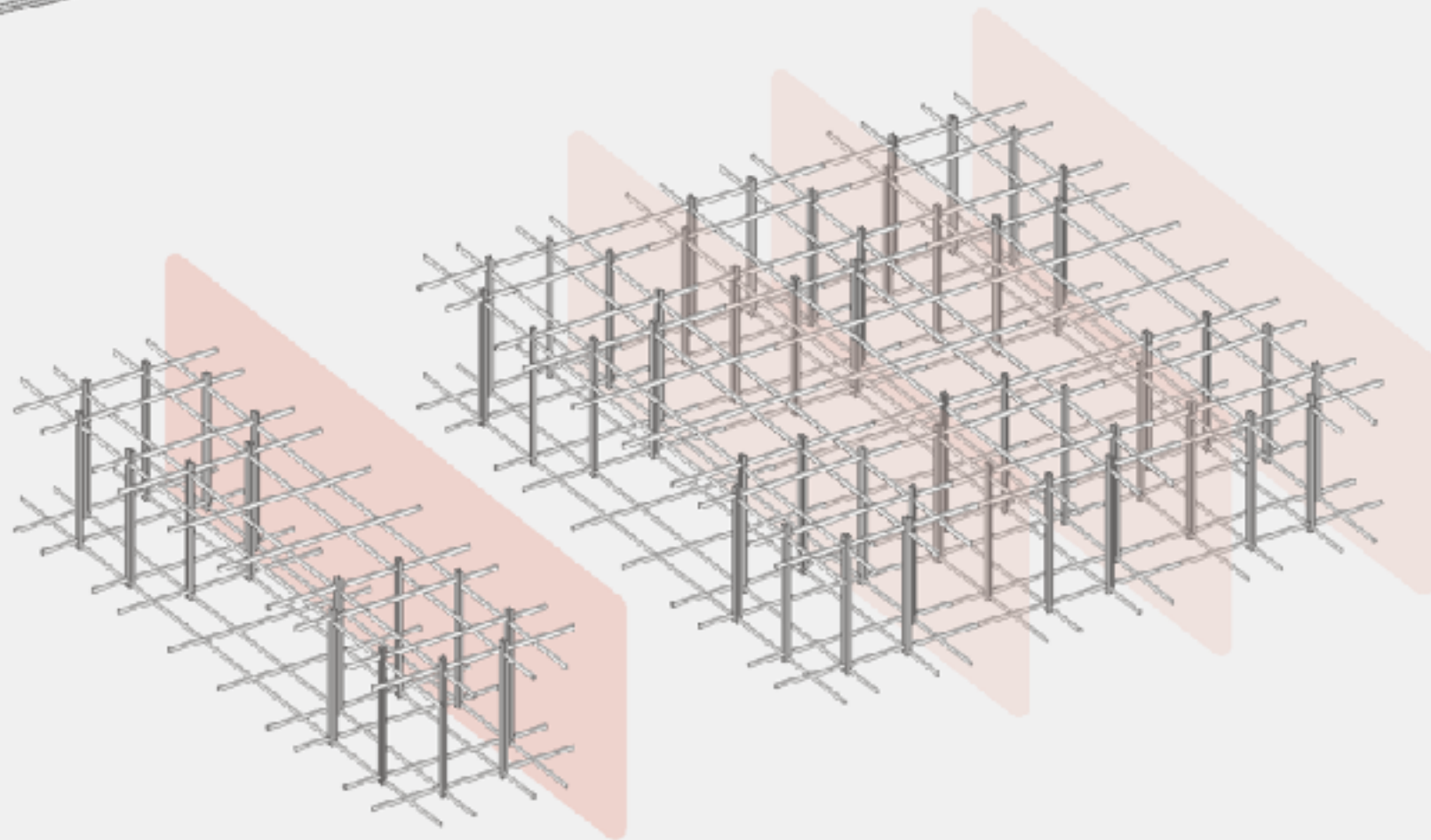
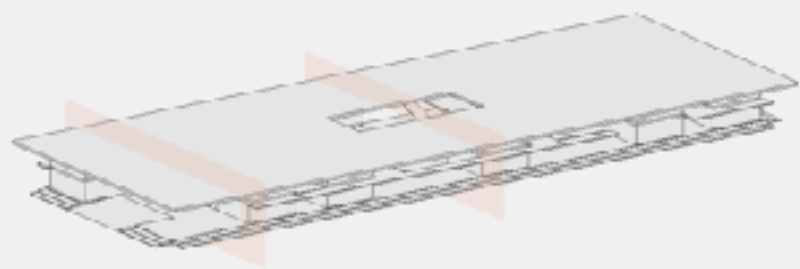

ÜTEMEZHETŐSÉG ÉS BŐVÍTHETŐSÉG



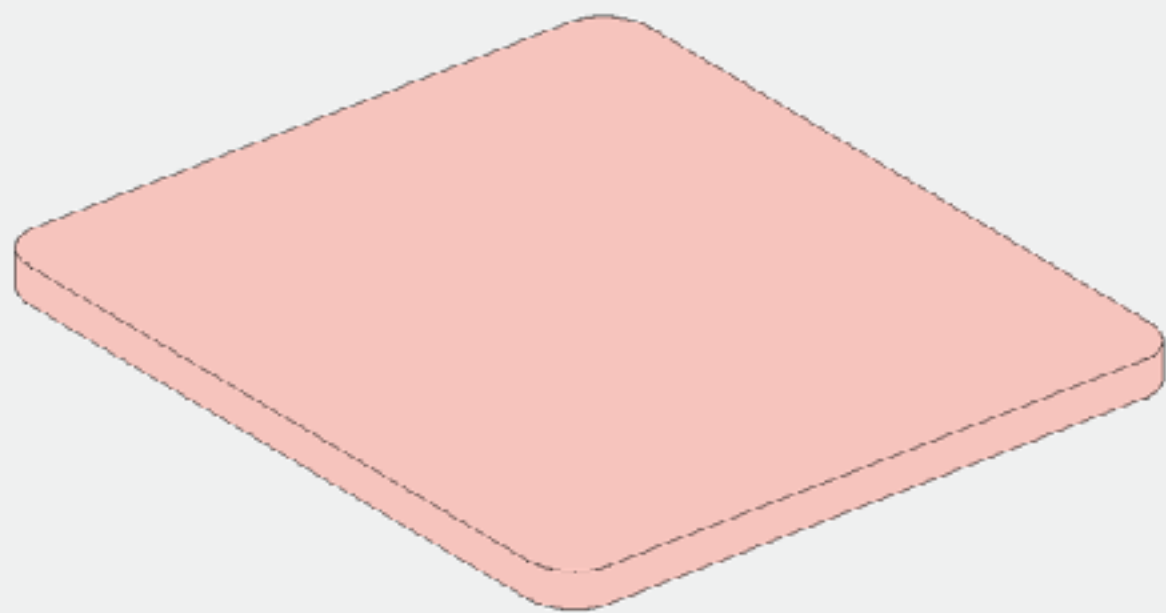

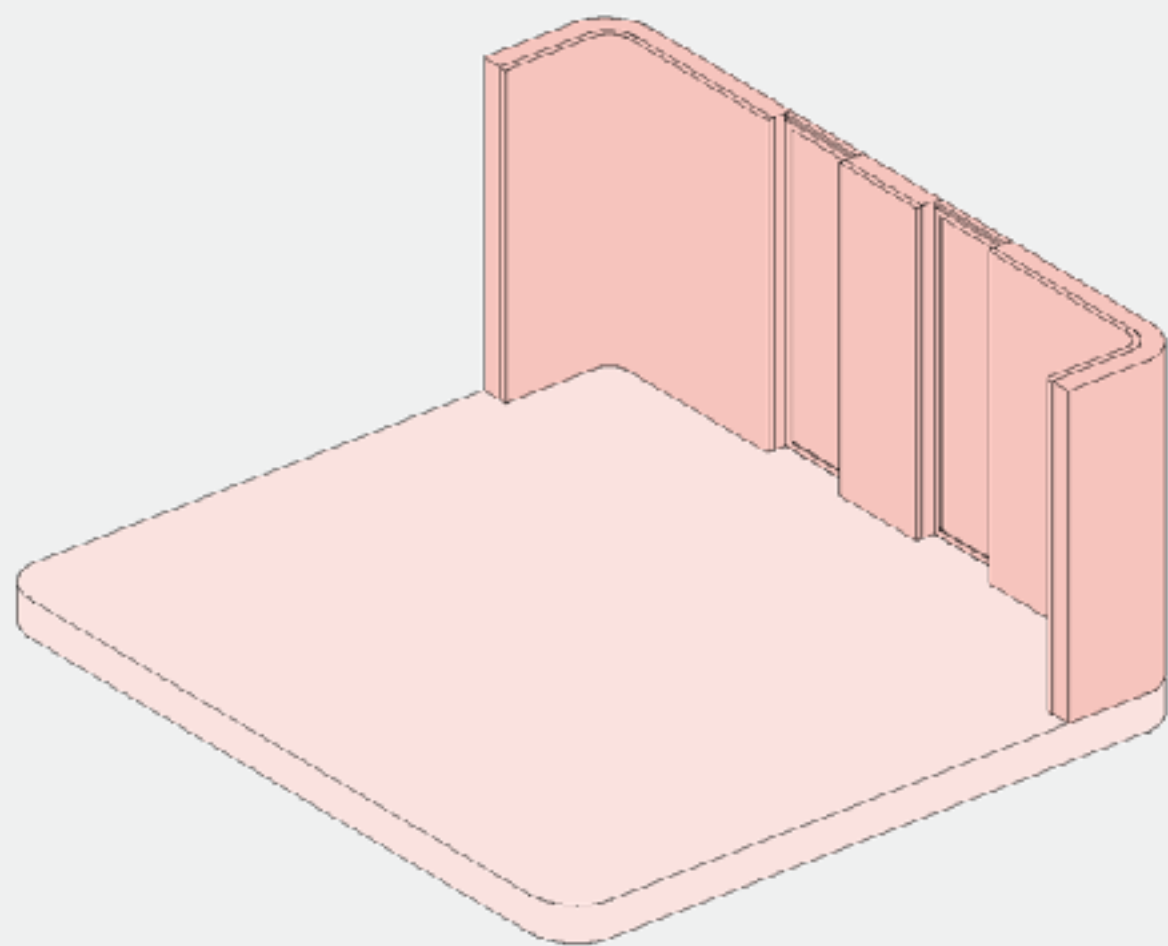

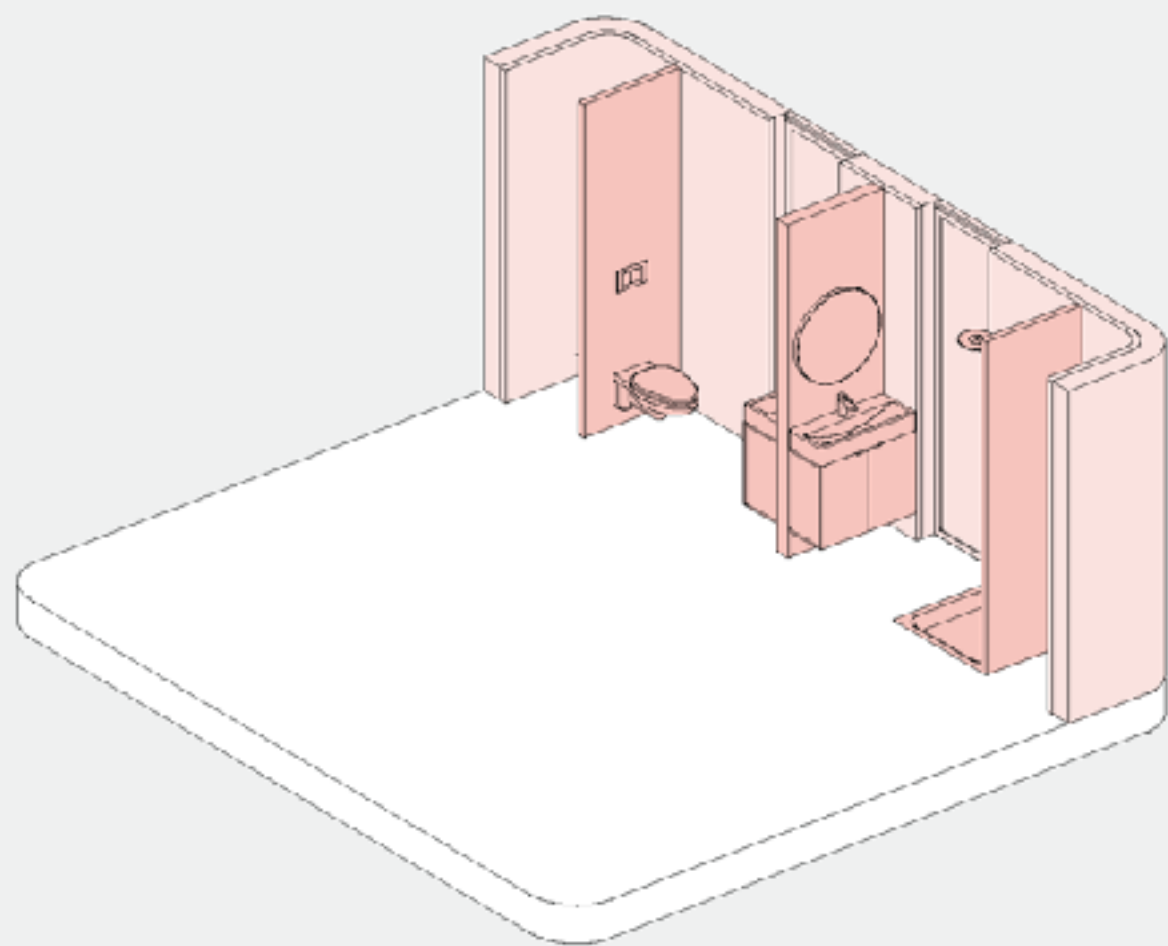

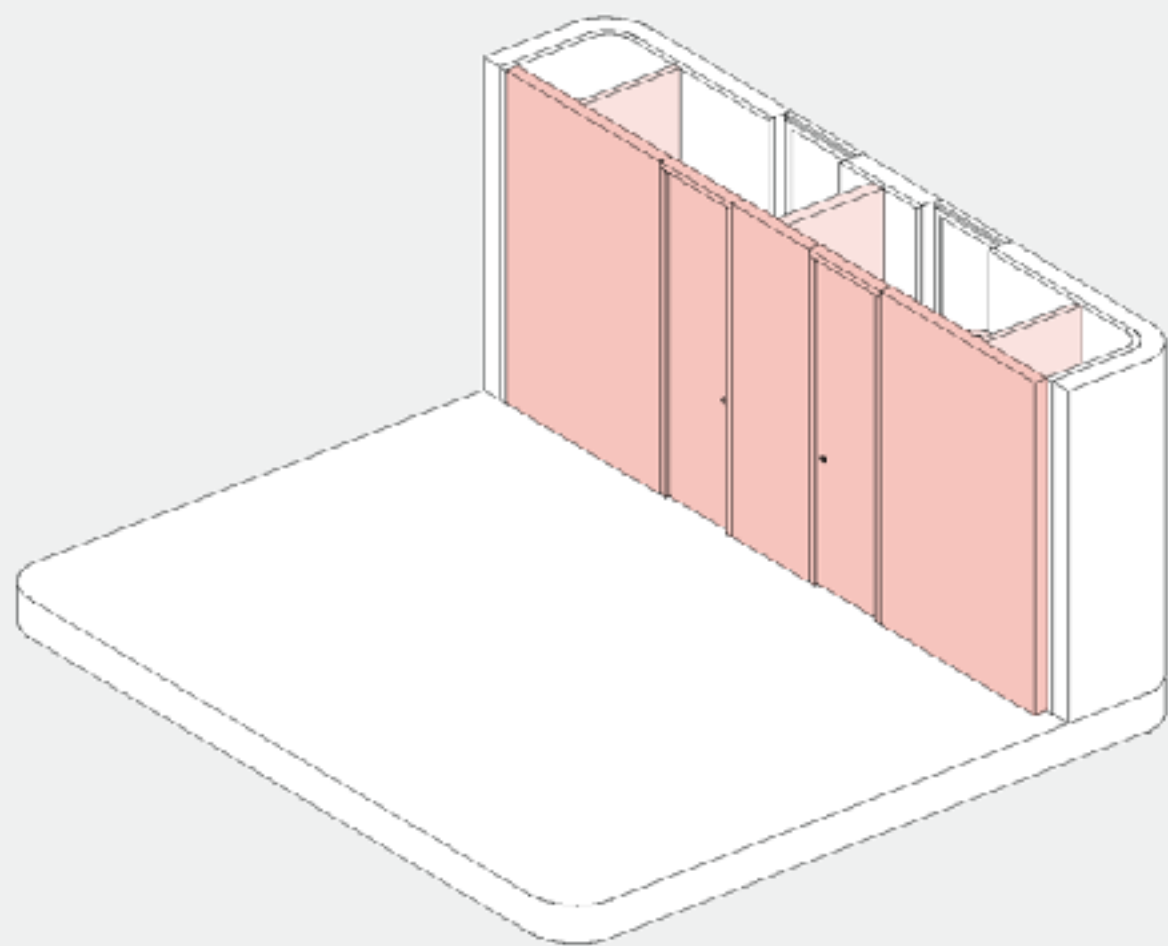

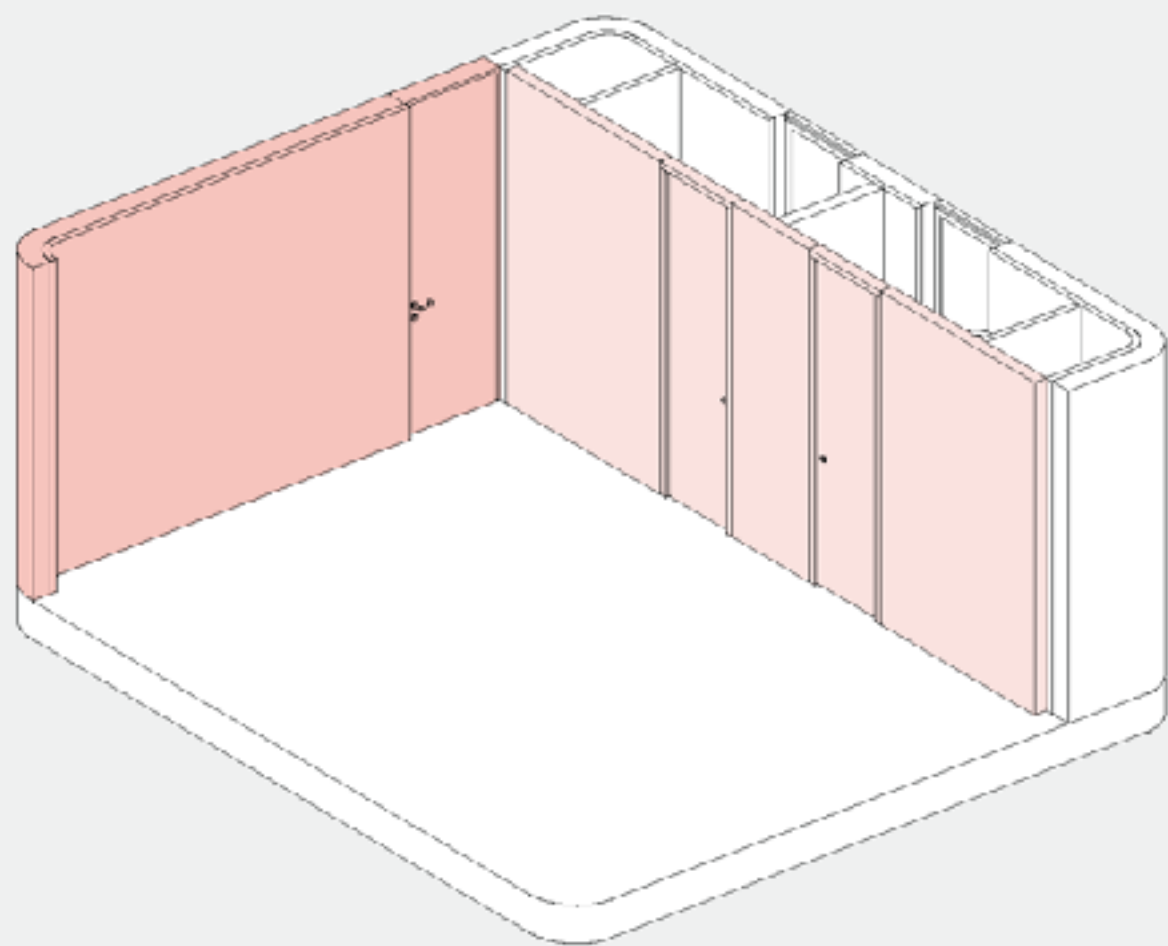

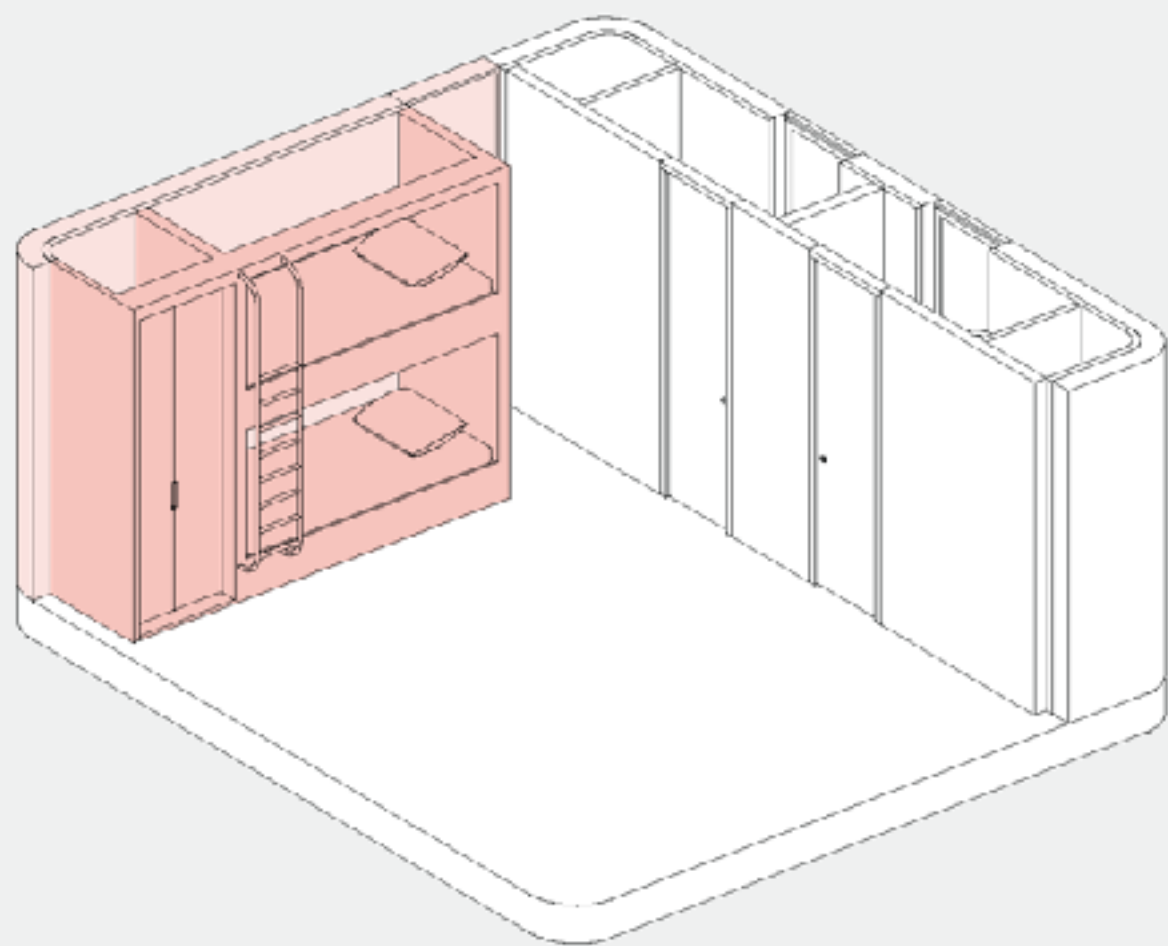

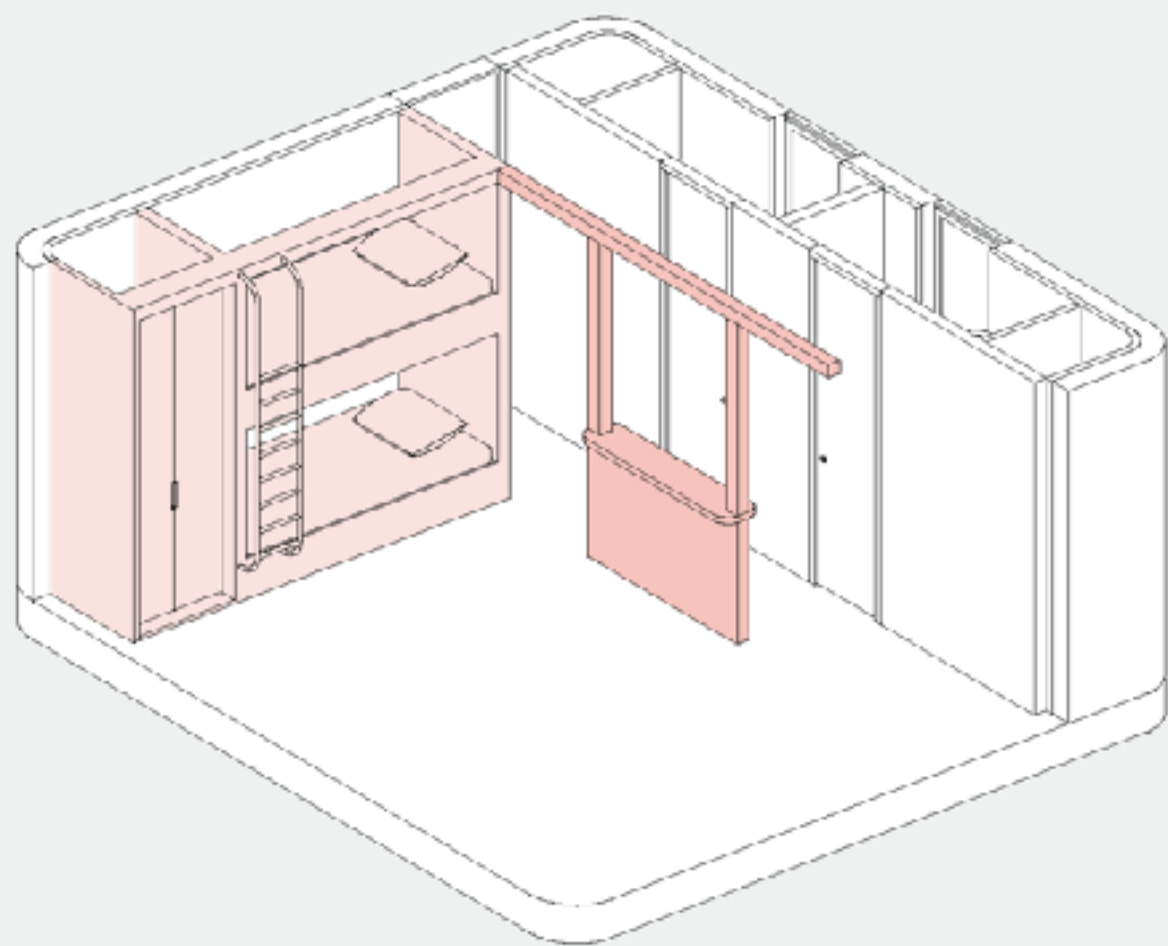

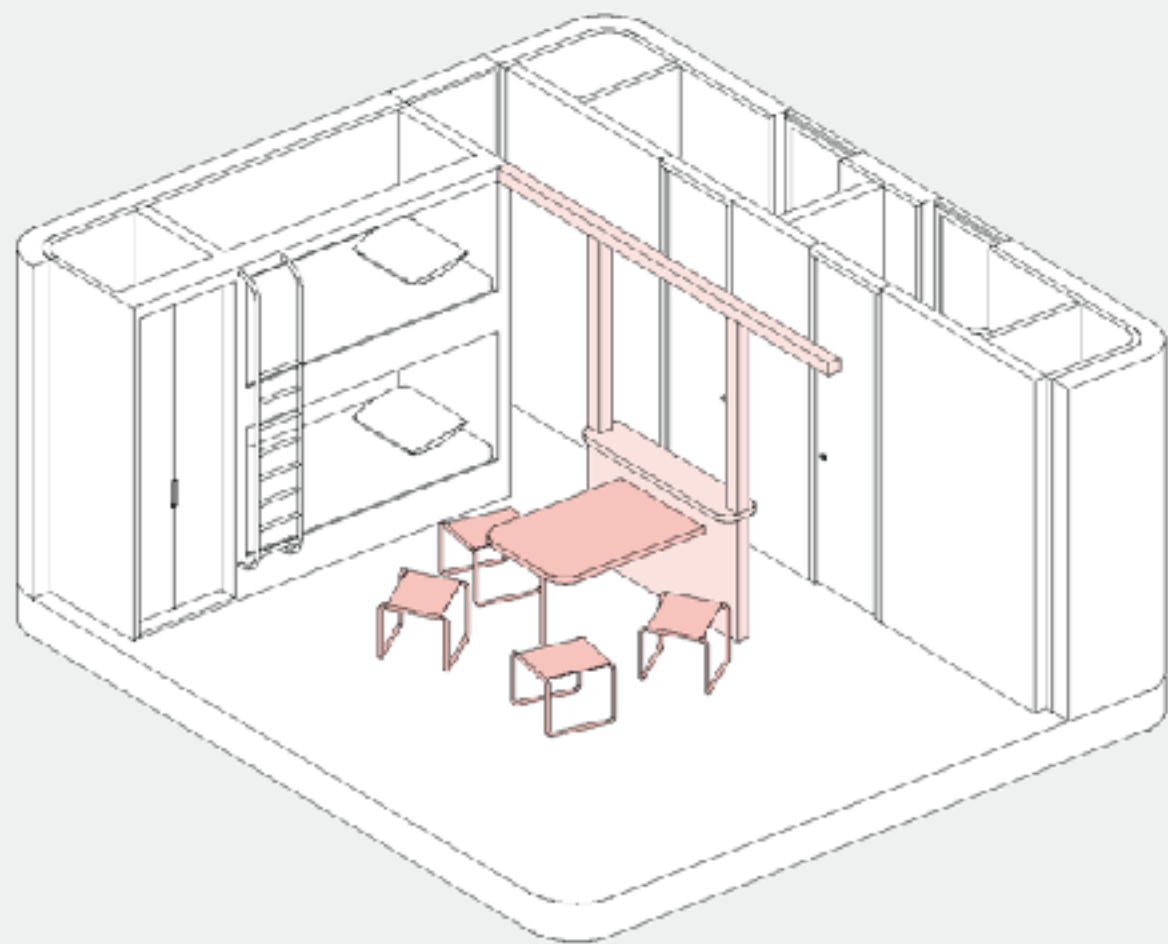

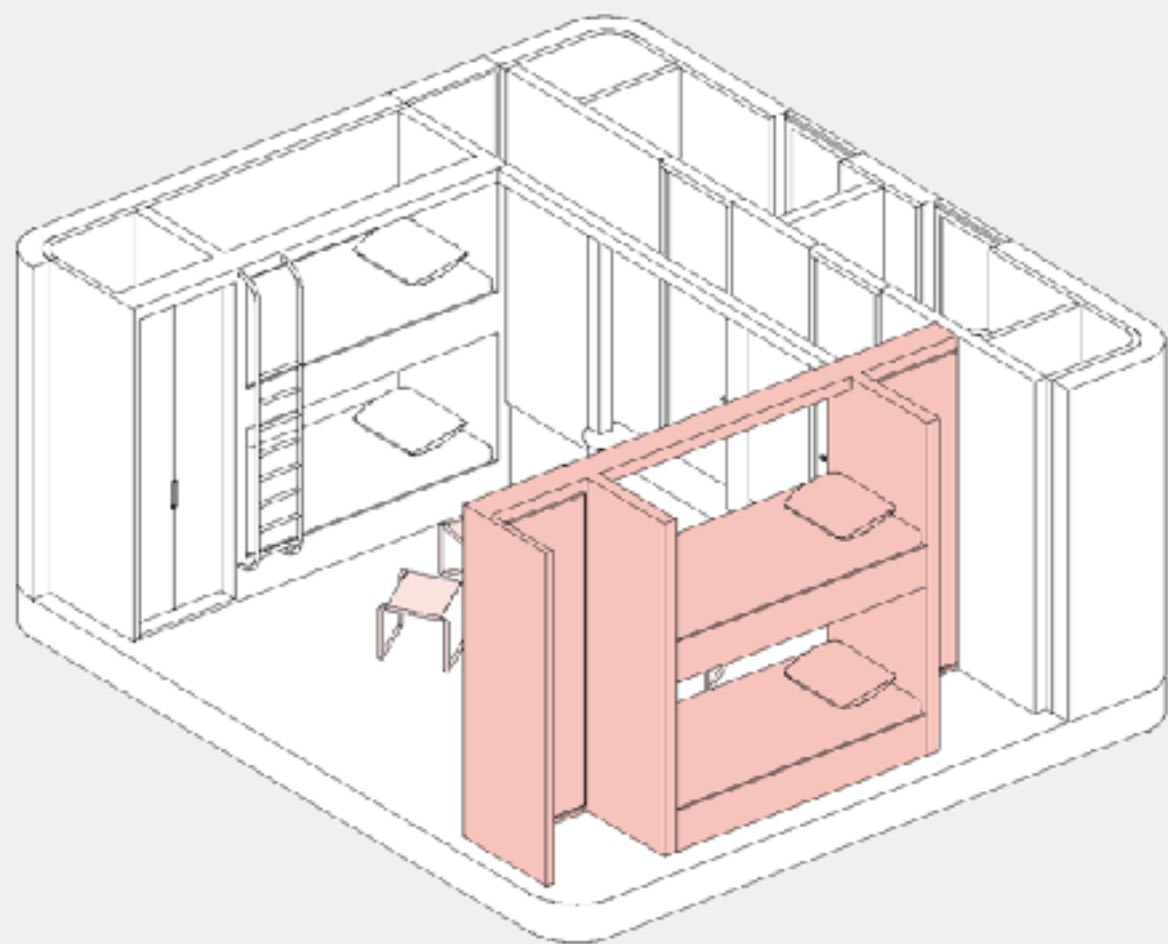

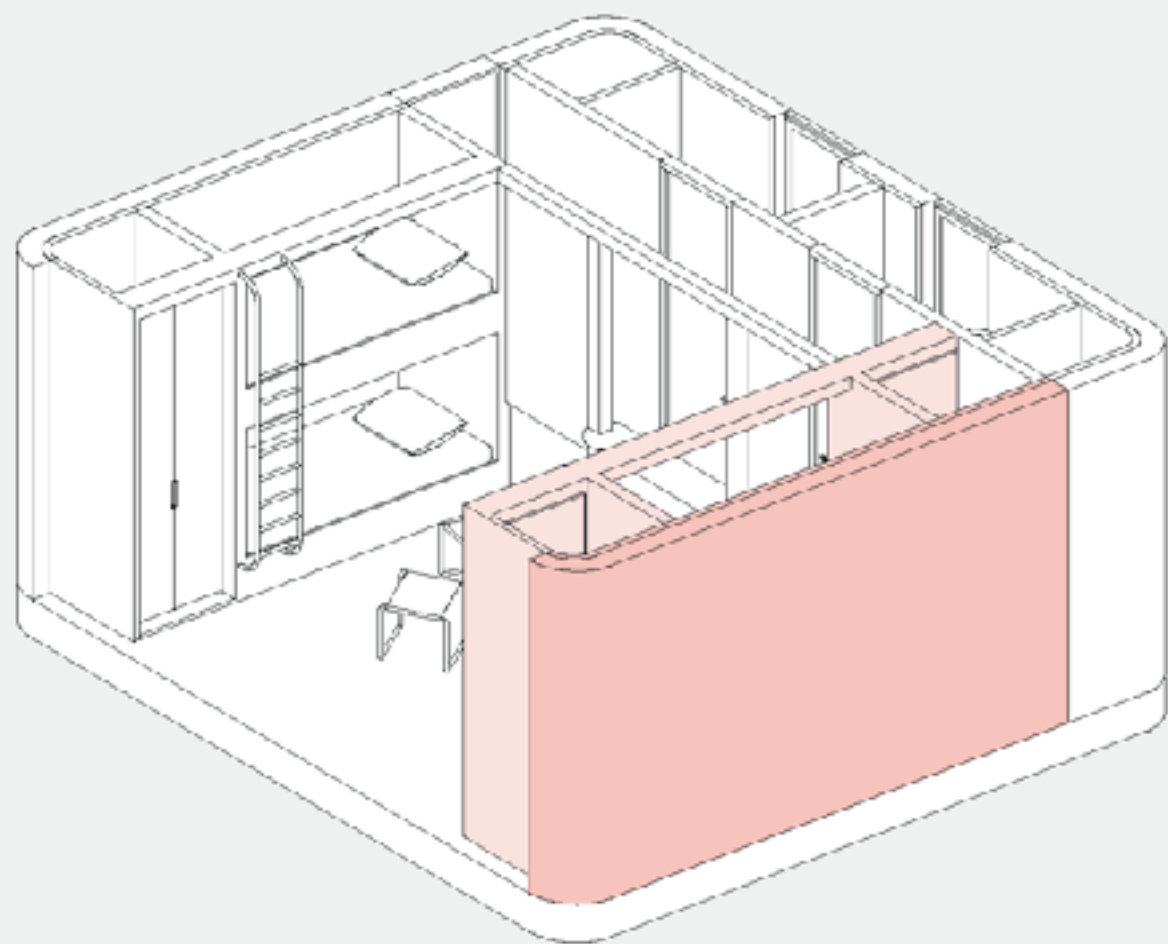

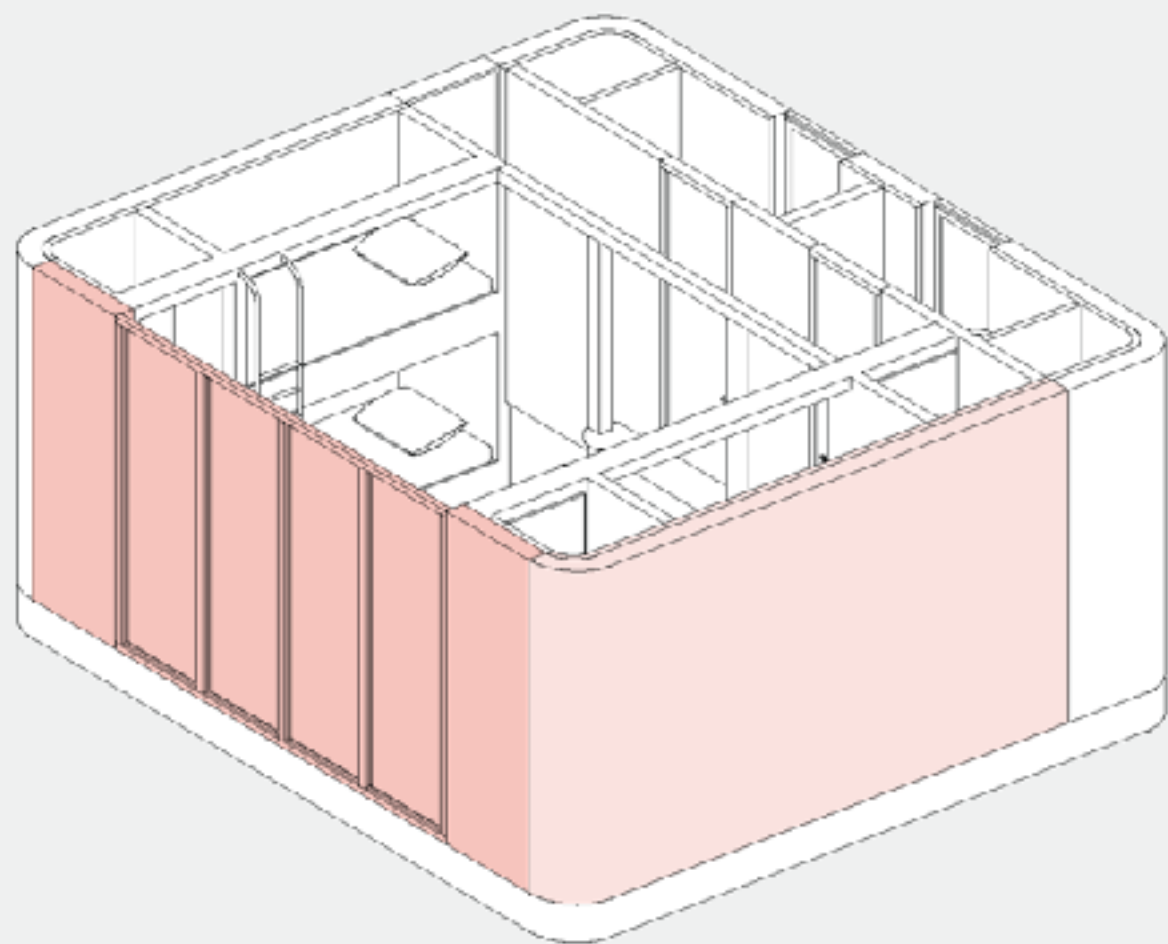

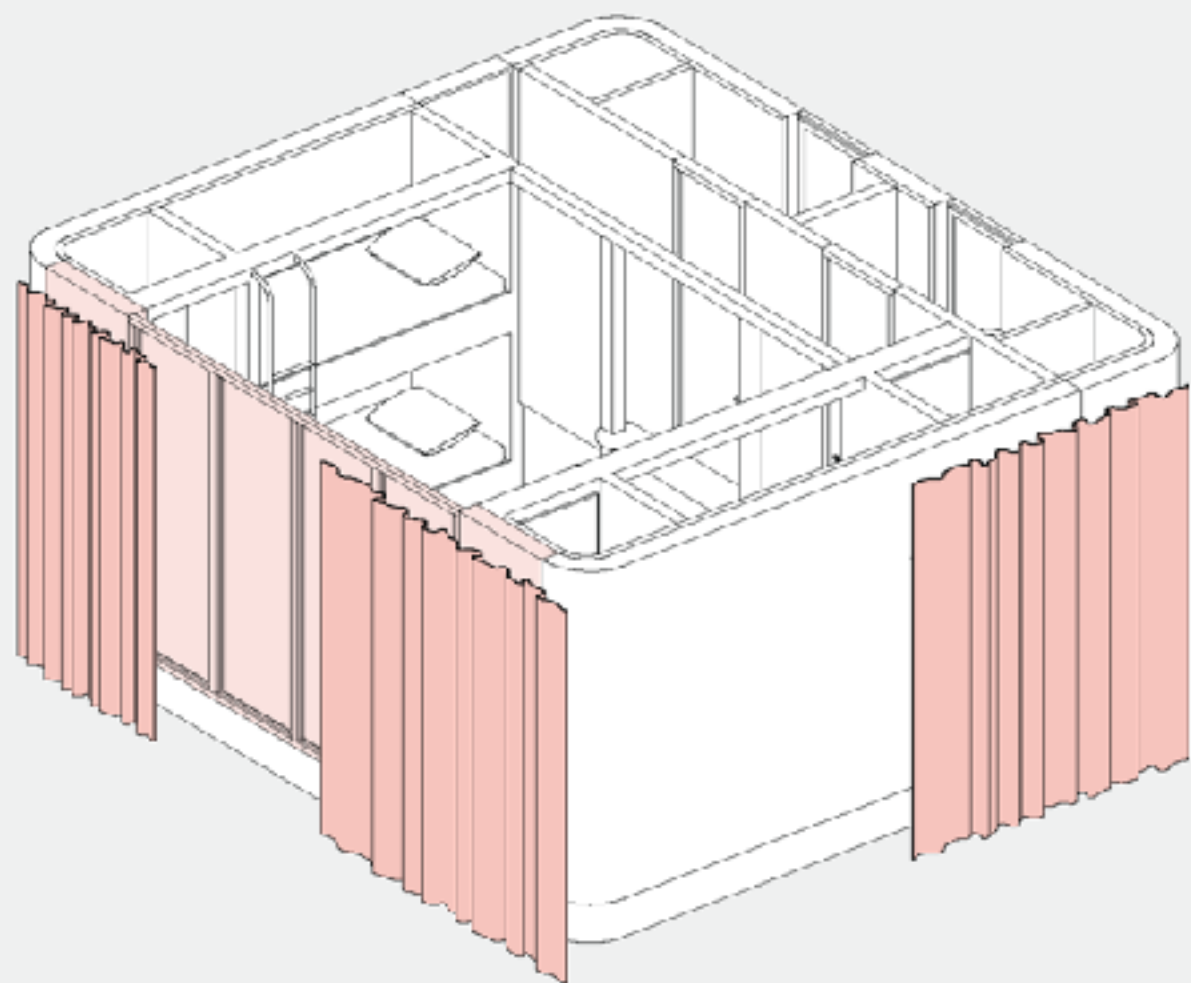

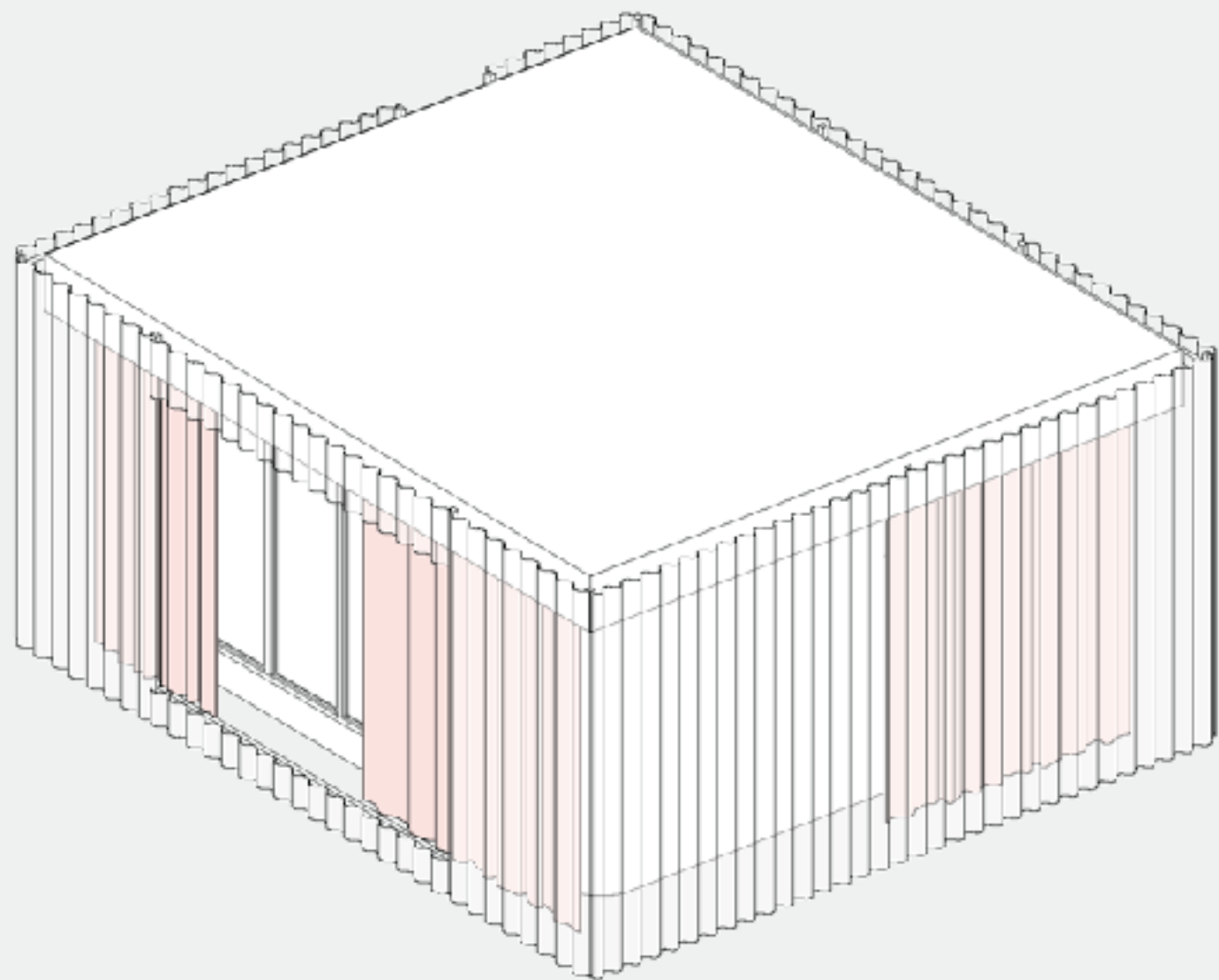



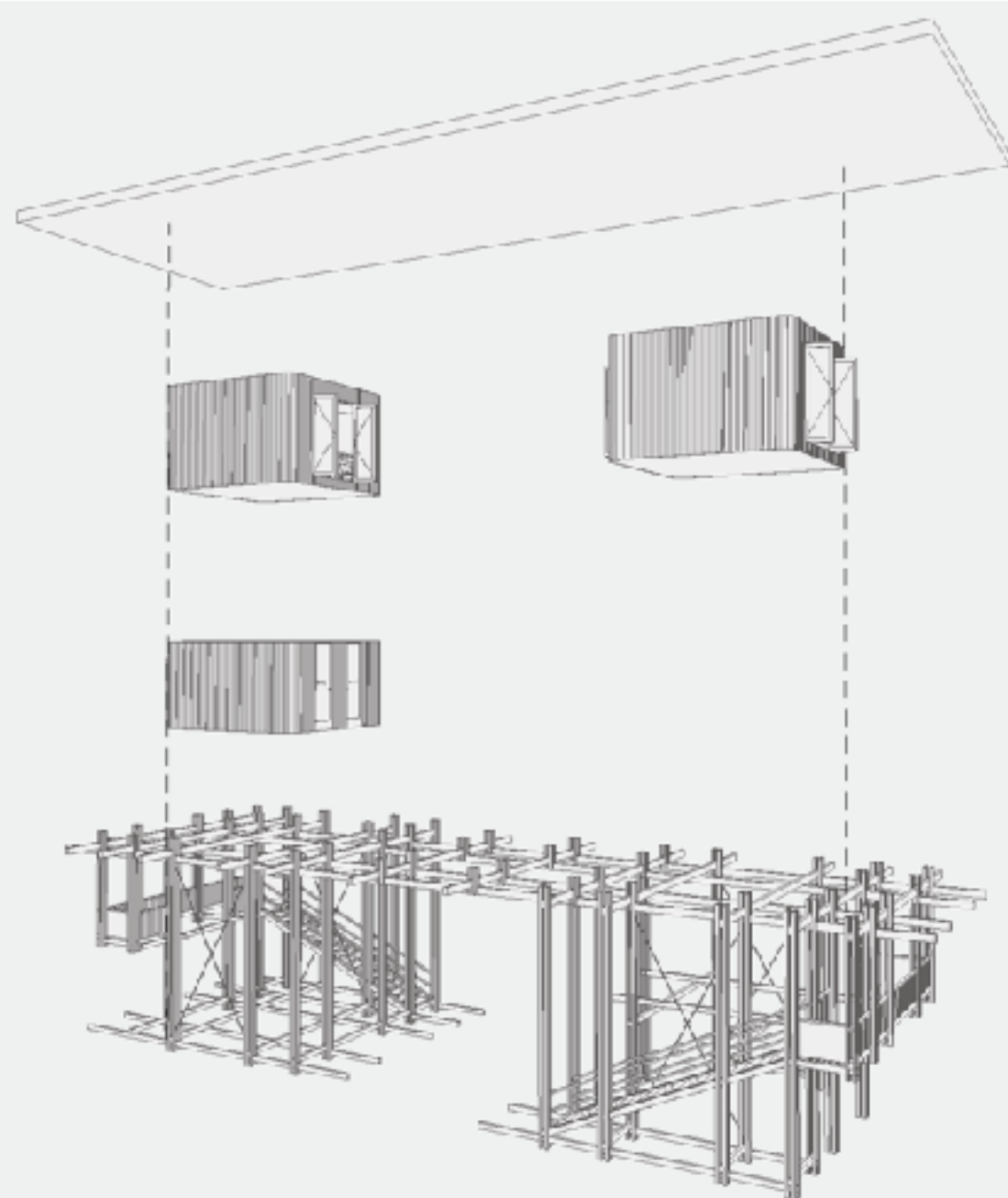
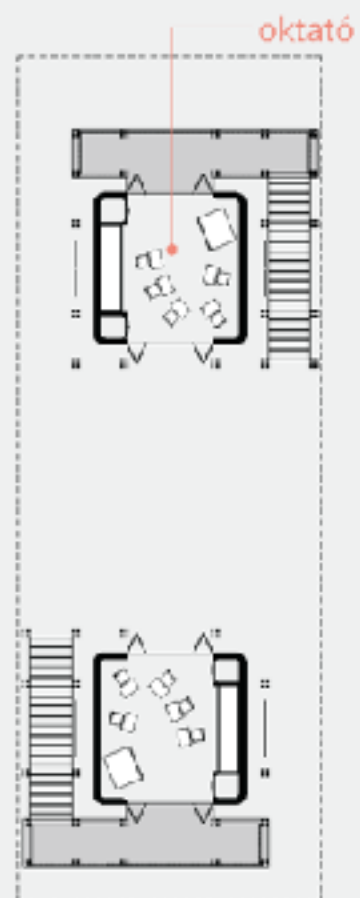
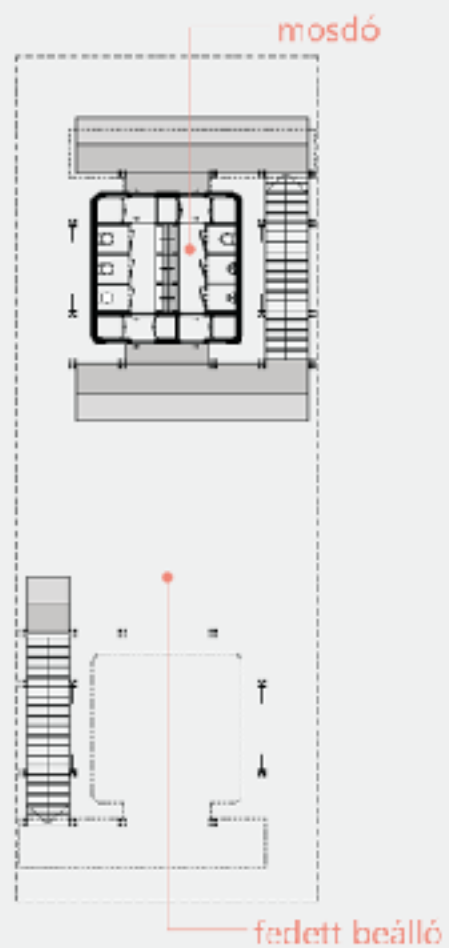



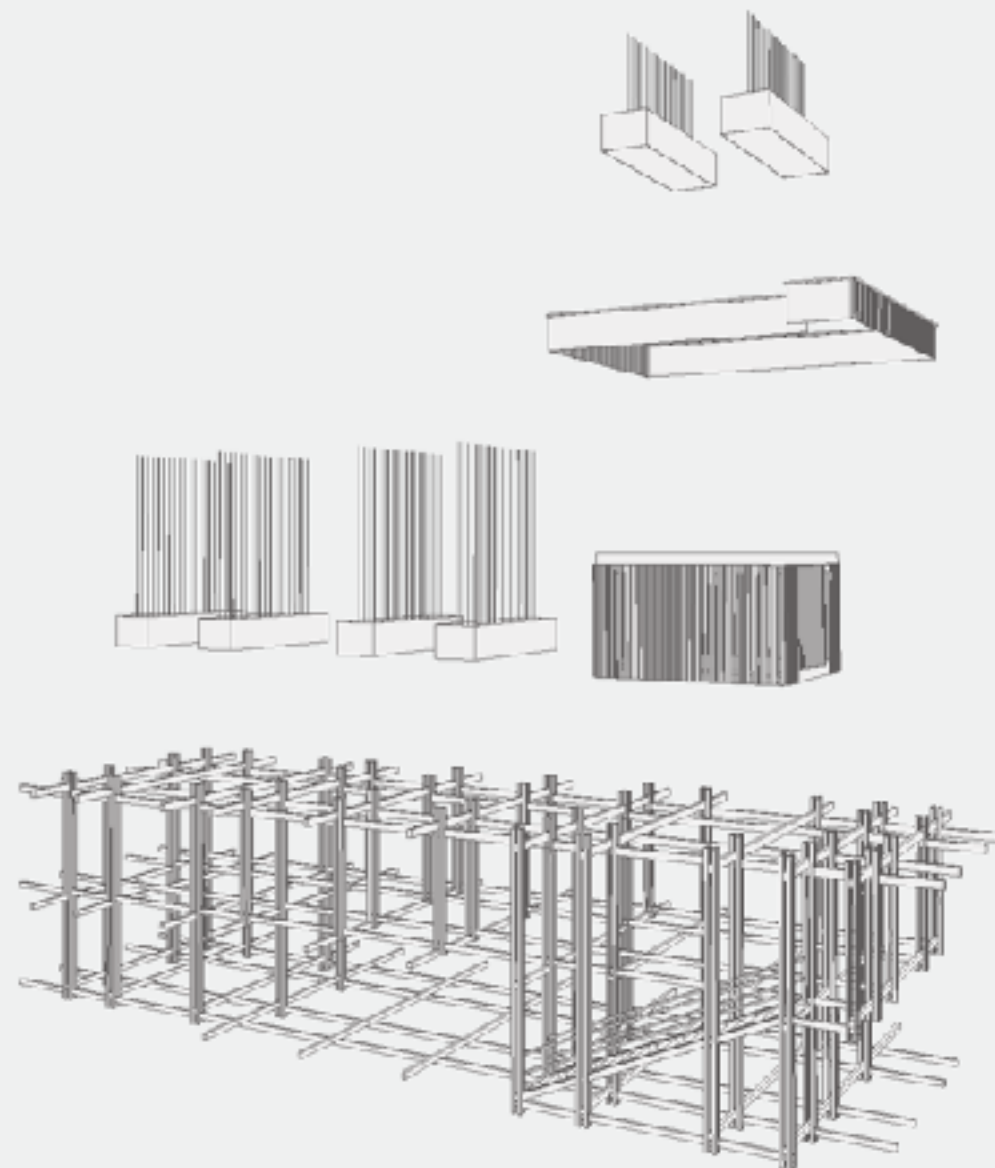
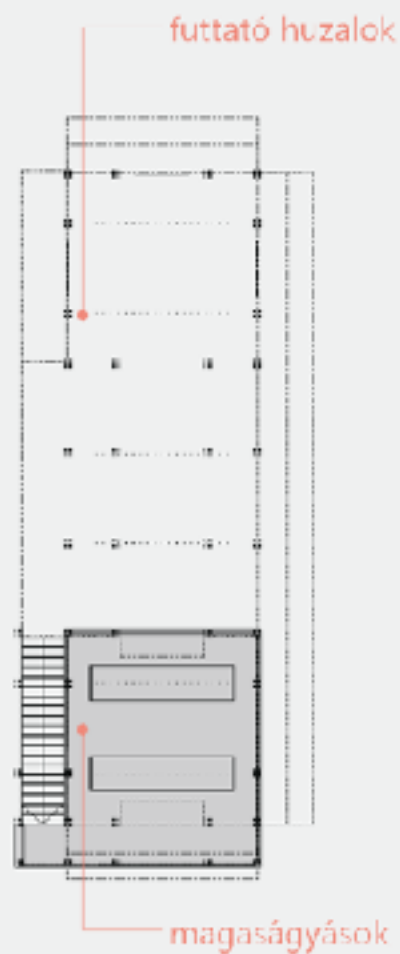
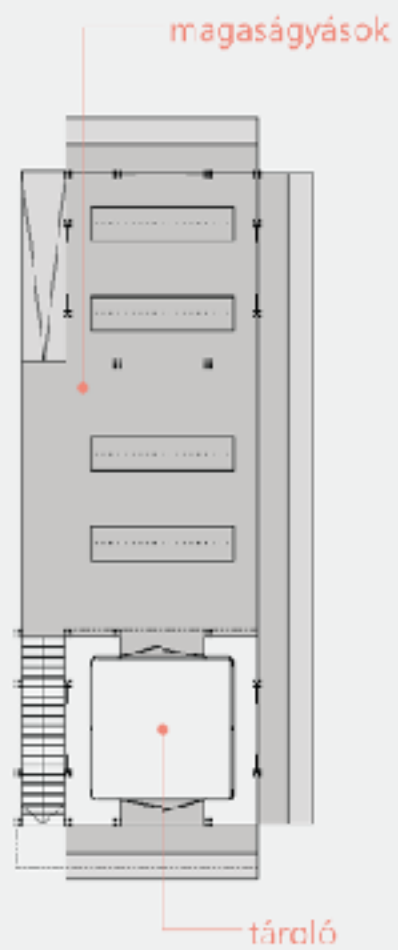





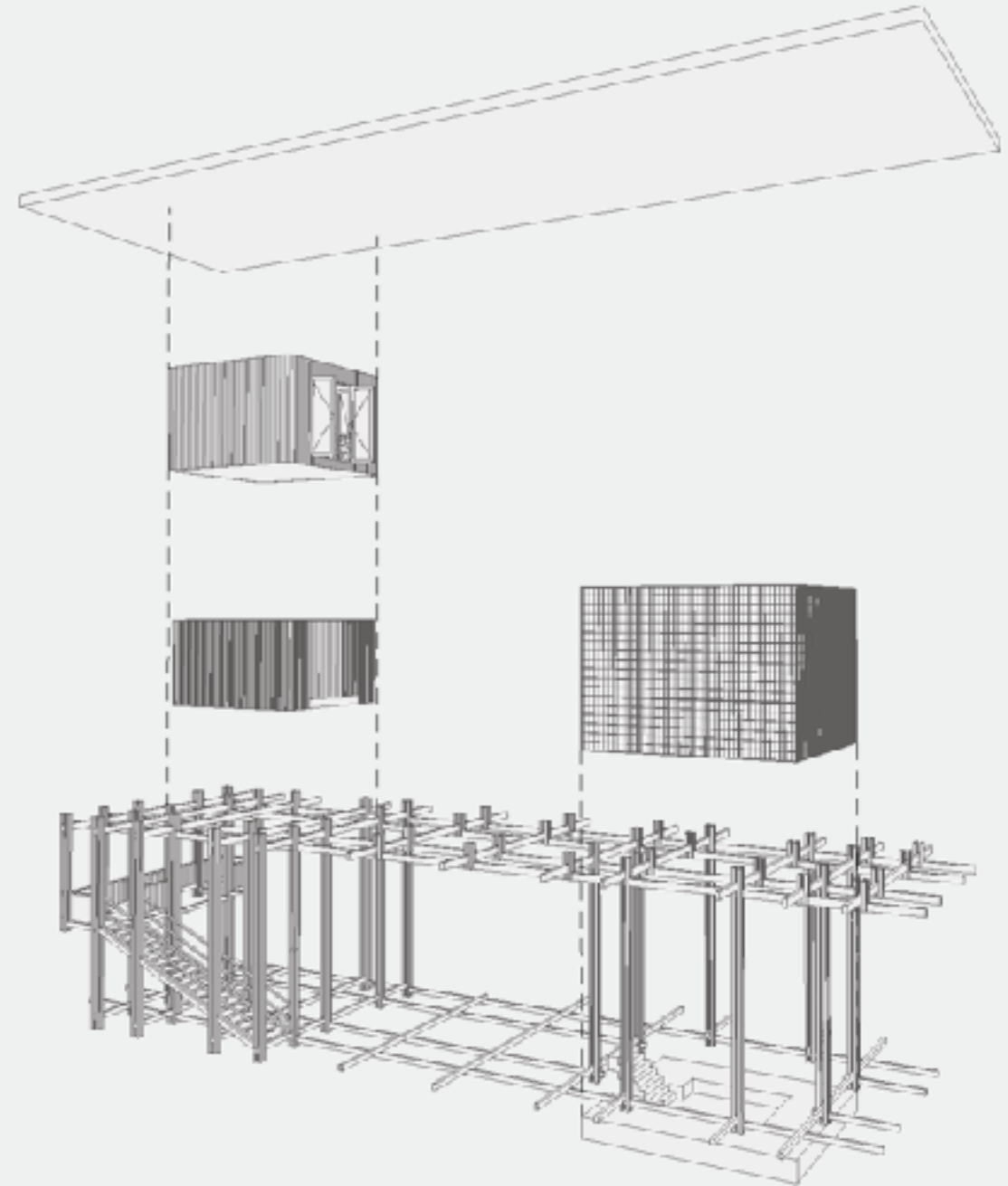
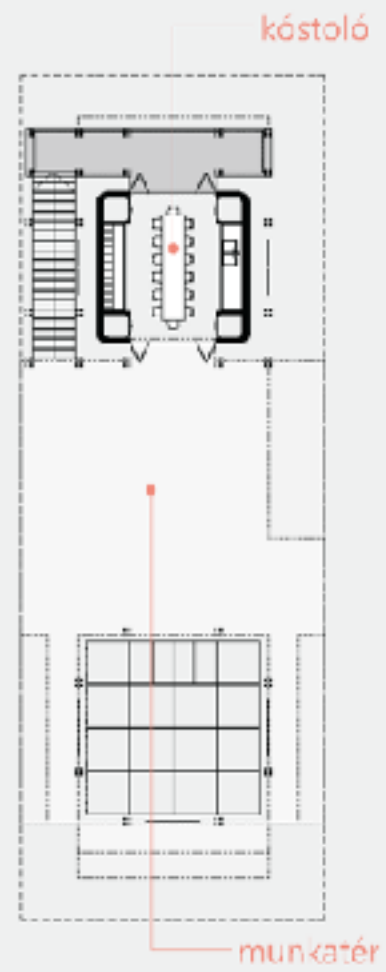
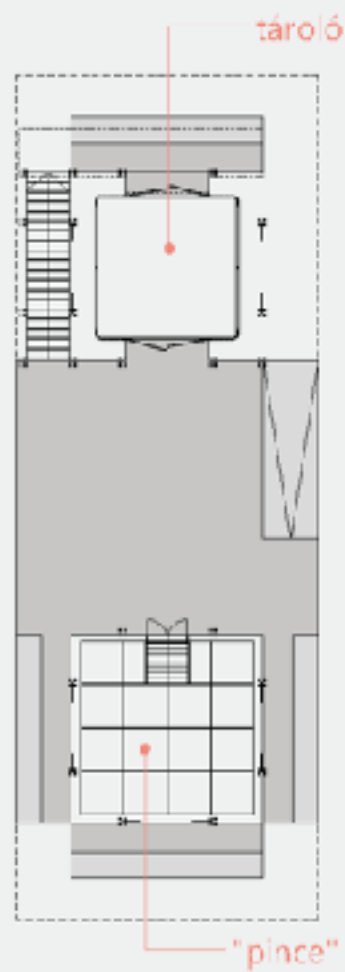





LÁTVÁNY A SZÁLLÁS KÖRNYEZETÉBŐL